

# Dual Power MOSFET Module

## VMK 90-02T2

$V_{DSS} = 200\text{ V}$   
 $I_{D25} = 83\text{ A}$   
 $R_{DS(on)} = 25\text{ m}\Omega$

Common-Source connected  
 N-Channel Enhancement Mode

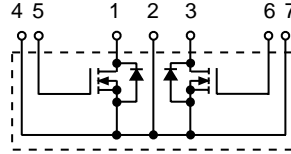

Symbol	Test Conditions	Maximum Ratings	
$V_{DSS}$	$T_J = 25^\circ\text{C}$ to $150^\circ\text{C}$	200	V
$V_{DGR}$	$T_J = 25^\circ\text{C}$ to $150^\circ\text{C}$ ; $R_{GS} = 6.8\text{ k}\Omega$	200	V
$V_{GS}$	Continuous	$\pm 20$	V
$V_{GSM}$	Transient	$\pm 30$	V
$I_{D25}$	$T_C = 25^\circ\text{C}$	83	A
$I_{D80}$	$T_C = 80^\circ\text{C}$	62	A
$I_{DM}$	$T_C = 25^\circ\text{C}$ , $t_p = 10\text{ }\mu\text{s}$ , pulse width limited by $T_{JM}$	330	A
$P_D$	$T_C = 25^\circ\text{C}$ , $T_J = 150^\circ\text{C}$ ,	380	W
$T_J$		-40 ... +150	$^\circ\text{C}$
$T_{JM}$		150	$^\circ\text{C}$
$T_{stg}$		-40 ... +125	$^\circ\text{C}$
$V_{ISOL}$	50/60 Hz	$t = 1\text{ min}$	2500 V~
	$I_{ISOL} \leq 1\text{ mA}$	$t = 1\text{ s}$	3000 V~
$M_d$	Mounting torque(M5 or 10-32 UNF)	2.5-4.0/22-35 Nm/lb.in.	
	Terminal connection torque (M5)	2.5-4.0/22-35 Nm/lb.in.	
<b>Weight</b>	Typical including screws	90	g

TO-240 AA  
 E 72873

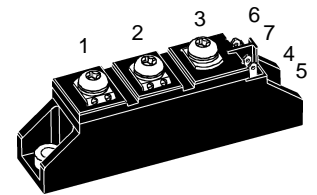

1, 3 = Drain, 2 = Common Source  
 5, 6 = Gate, 4, 7 = Kelvin Source

### Features

- Two MOSFET with common source
- International standard package JEDEC TO-240 AA
- Direct copper bonded  $\text{Al}_2\text{O}_3$  ceramic base plate
- Isolation voltage 3000 V~
- Low  $R_{DS(on)}$  HDMOS™ process
- Low package inductance for high speed switching
- Kelvin source contact
- Keyed twin plugs

### Applications

- Push-pull inverters
- Switched-mode and resonant-mode power supplies
- Uninterruptible power supplies (UPS)
- AC static switches

### Advantages

- Easy to mount with two screws
- Space and weight savings
- High power density
- Low losses

Symbol	Test Conditions	Characteristic Values ( $T_J = 25^\circ\text{C}$ , unless otherwise specified)		
		min.	typ.	max.
$V_{DSS}$	$V_{GS} = 0\text{ V}$ , $I_D = 1\text{ mA}$	200		V
$V_{GS(th)}$	$V_{DS} = V_{GS}$ , $I_D = 3\text{ mA}$	2		4 V
$I_{GSS}$	$V_{GS} = \pm 20\text{ V DC}$ , $V_{DS} = 0$			500 nA
$I_{DSS}$	$V_{DS} = 0.8 \cdot V_{DSS}$ , $V_{GS} = 0\text{ V}$ , $T_J = 25^\circ\text{C}$ $V_{GS} = 0\text{ V}$ , $T_J = 125^\circ\text{C}$			400 $\mu\text{A}$ 2 mA
$R_{DS(on)}$	$V_{GS} = 10\text{ V}$ , $I_D = 0.5 \cdot I_{D25}$ Pulse test, $t \leq 300\text{ }\mu\text{s}$ , duty cycle $d \leq 2\%$			25 $\text{m}\Omega$

Data per MOSFET unless otherwise stated.  
 IXYS reserves the right to change limits, test conditions and dimensions

Symbol	Test Conditions	Characteristic Values ( $T_J = 25^\circ\text{C}$ , unless otherwise specified)		
		min.	typ.	max.
$g_{fs}$	$V_{DS} = 10\text{ V}; I_D = 0.5 \cdot I_{D25}$ pulsed		60	S
$C_{iss}$	} $V_{GS} = 0\text{ V}, V_{DS} = 25\text{ V}, f = 1\text{ MHz}$		9000	15000 pF
$C_{oss}$			1600	4500 pF
$C_{rss}$			600	1500 pF
$t_{d(on)}$	} $V_{GS} = 10\text{ V}, V_{DS} = 0.5 \cdot V_{DSS}, I_D = 0.5 \cdot I_{D25}$ $R_G = 1\ \Omega$ (External), resistive load			70 ns
$t_r$				80 ns
$t_{d(off)}$				200 ns
$t_f$				100 ns
$Q_g$	} $V_{GS} = 10\text{ V}, V_{DS} = 0.5 \cdot V_{DSS}, I_D = 0.5 \cdot I_{D25}$		380	450 nC
$Q_{gs}$			70	110 nC
$Q_{gd}$			190	230 nC
$R_{thJC}$				0.33 K/W
$R_{thJK}$	with heat transfer paste			0.53 K/W
$d_s$	Creepage distance on surface	12.7		mm
$d_A$	Strike distance through air	9.6		mm
$a$	Max. allowable acceleration		50	$\text{m/s}^2$

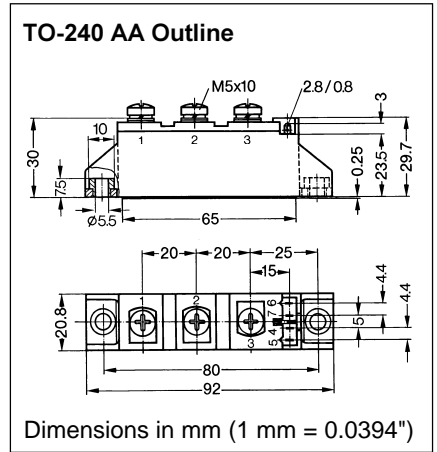

Symbol	Test Conditions	Characteristic Values ( $T_J = 25^\circ\text{C}$ , unless otherwise specified)		
		min.	typ.	max.
$I_S$	$V_{GS} = 0\text{ V}$			83 A
$I_{SM}$	Repetitive; pulse width limited by $T_{JM}$			330 A
$V_{SD}$	$I_F = I_S; V_{GS} = 0\text{ V}$ , Pulse test, $t \leq 300\ \mu\text{s}$ , duty cycle $d \leq 2\%$		1.0	1.2 V
$t_{rr}$	$I_F = I_S, -di/dt = 100\text{ A}/\mu\text{s}, V_{DS} = 100\text{ V}, V_{GS} = 0\text{ V}$		400	750 ns

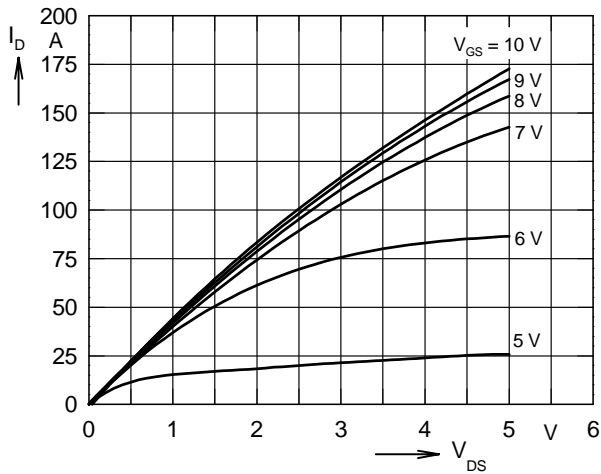

Fig. 1 Typical output characteristics  $I_D = f(V_{DS})$

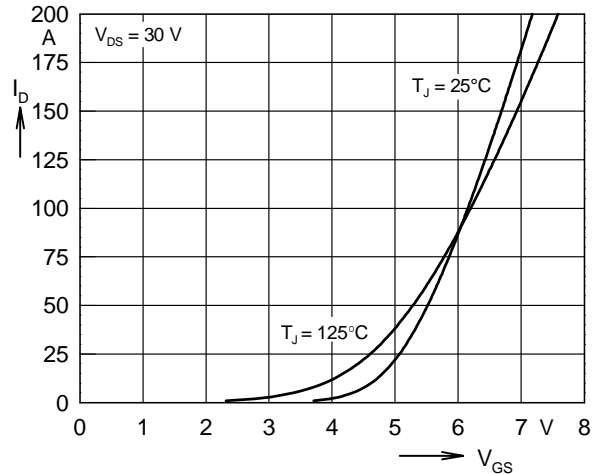

Fig. 2 Typical transfer characteristics  $I_D = f(V_{GS})$

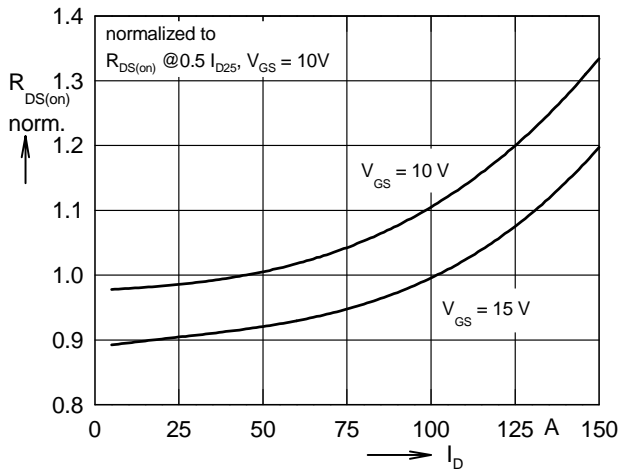

Fig. 3 Typical normalized  $R_{DS(on)} = f(I_D)$

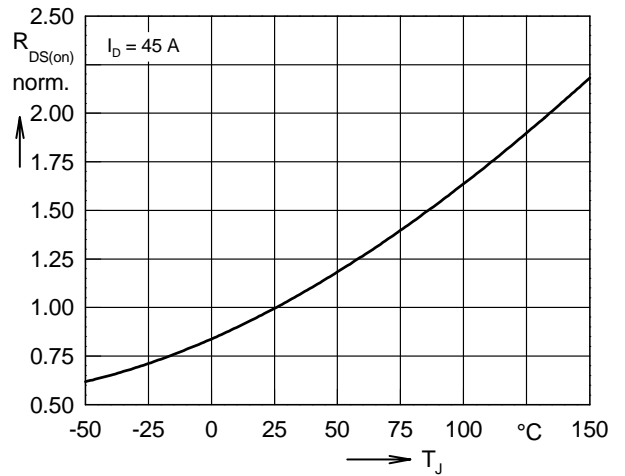

Fig. 4 Typical normalized  $R_{DS(on)} = f(T_J)$

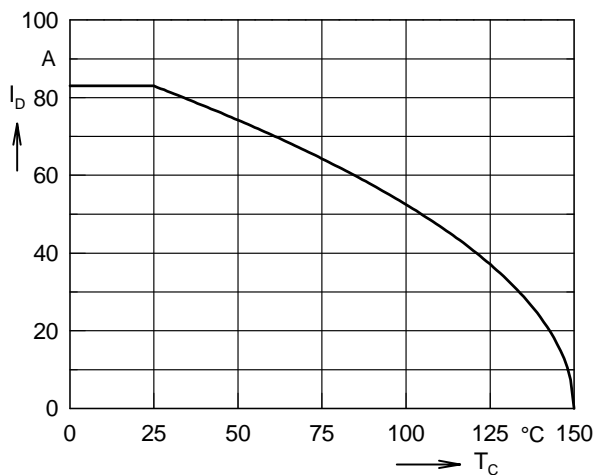

Fig. 5 Continuous drain current  $I_D = f(T_C)$

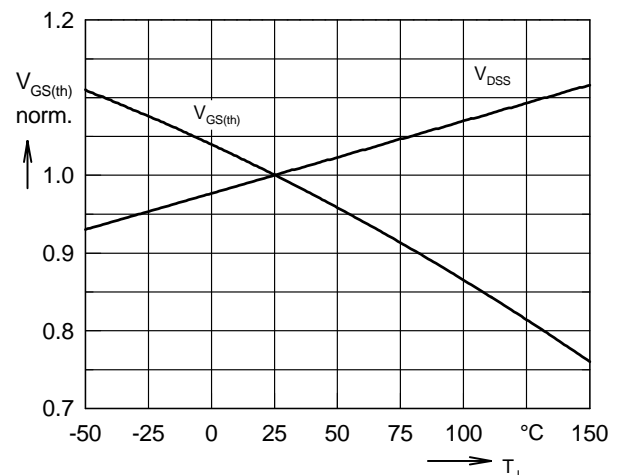

Fig. 6 Typical normalized  $V_{DS} = f(T_J)$ ,  $V_{GS(th)} = f(T_J)$

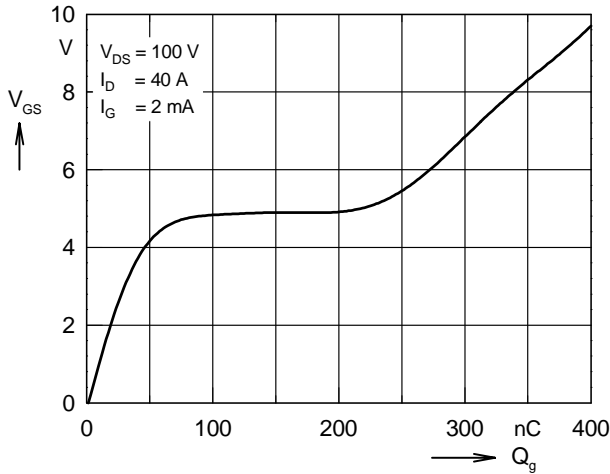

Fig. 7 Typical turn-on gate charge characteristics

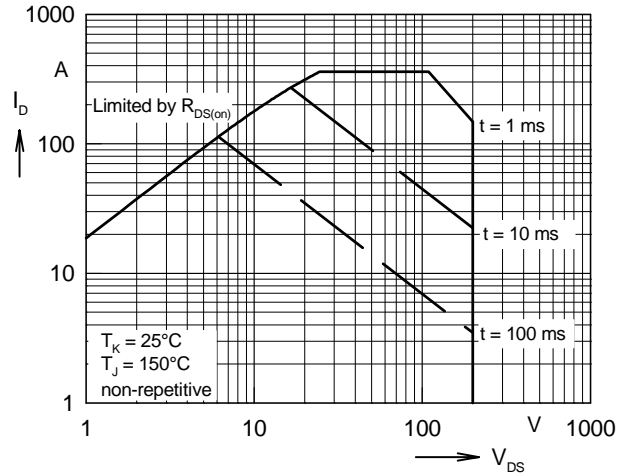

Fig. 8 Forward Safe Operating Area,  $I_D = f(V_{DS})$

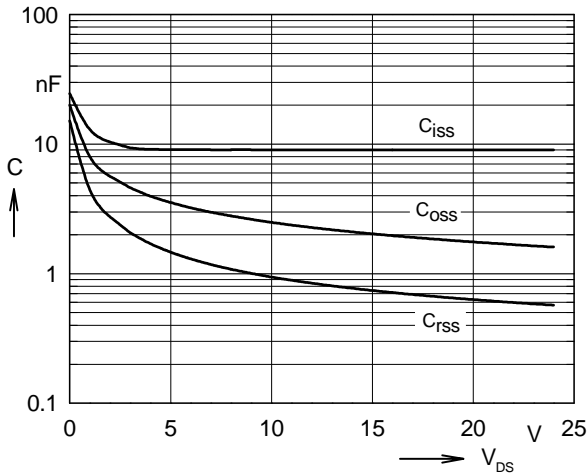

Fig. 9 Typical capacitances  $C = f(V_{DS})$ ,  $f = 1 \text{ MHz}$

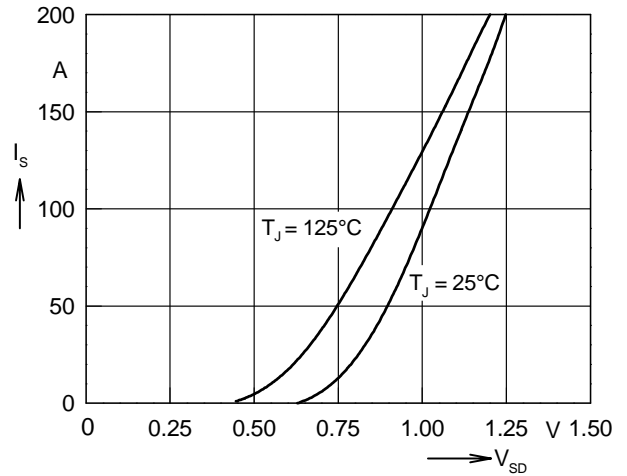

Fig. 10 Typical forward characteristics of reverse diode,  $I_S = f(V_{SD})$

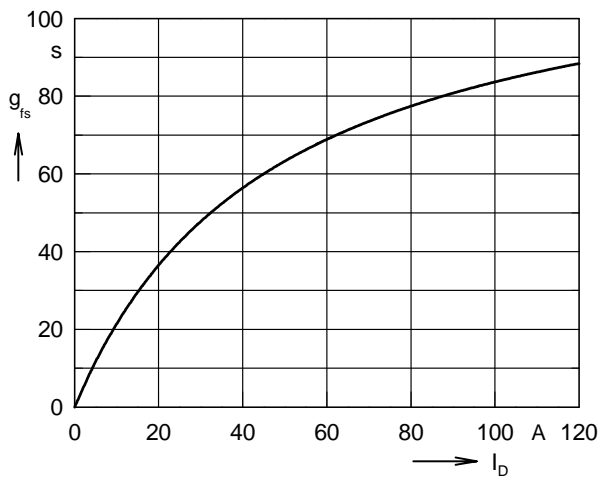

Fig. 11 Typical transconductance  $g_{fs} = f(I_D)$

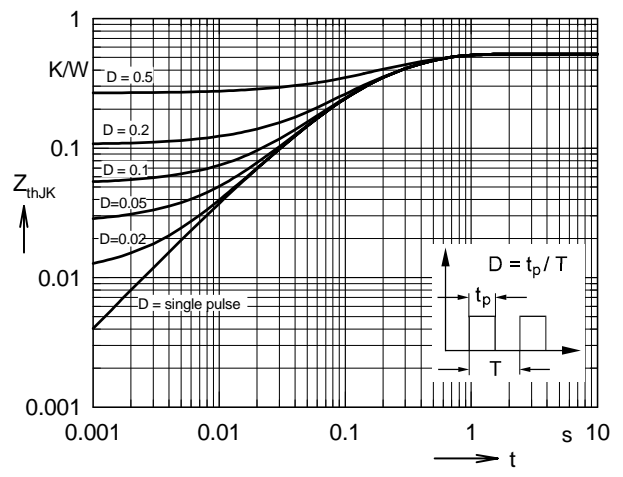

Fig. 12 Transient thermal resistance  $Z_{thJK} = f(t_p)$

Copyright © Each Manufacturing Company.

All Datasheets cannot be modified without permission.

This datasheet has been download from :

[www.AllDataSheet.com](http://www.AllDataSheet.com)

100% Free DataSheet Search Site.

Free Download.

No Register.

Fast Search System.

[www.AllDataSheet.com](http://www.AllDataSheet.com)