

February 1996

74LVX3L384 10-Bit Low Power Bus Switch

General Description

The LVX3L384 provides 10 bits of high-speed CMOS TTL-compatible bus switches. The low on resistance of the switch allows inputs to be connected to outputs without adding propagation delay or generating additional ground bounce noise. The device is organized as two 5-bit switches with separate bus enable (\overline{BE}) signals. When \overline{BE} is low, the switch is on and port A is connected to port B. When \overline{BE} is high, the switch is open and a high-impedance state exists between the two ports.

Features

- 5Ω switch connection between two ports
- Zero propagation delay
- Ultra low power with 0.2 μA typical I_{CC}
- Zero ground bounce in flow-through mode
- Control inputs compatible with TTL level
- Available in SOIC, TSSOP and QSOP (SSOP 0.15" Body width)

Logic Diagram

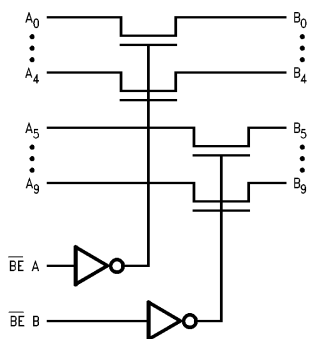

TL/F/11653-1

Connection Diagram

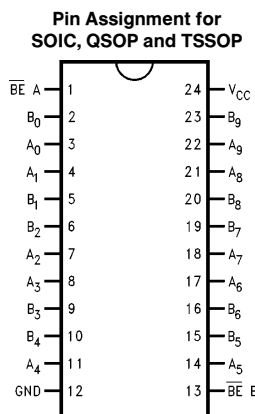

TL/F/11653-2

Truth Table

\overline{BE} A	\overline{BE} B	B ₀ -B ₄	B ₅ -B ₉	Function
L	L	A ₀ -A ₄	A ₅ -A ₉	Connect
L	H	A ₀ -A ₄	HIGH-Z State	Connect
H	L	HIGH-Z State	A ₅ -A ₉	Connect
H	H	HIGH-Z State	HIGH-Z State	Disconnect

Pin Names	Description
\overline{BE} A, \overline{BE} B	Bus Switch Enable
A ₀ -A ₉	Bus A
B ₀ -B ₉	Bus B

	SOIC JEDEC	QSOP	TSSOP
Order Number	74LVX3L384WM 74LVX3L384WMX	74LVX3L384QSC 74LVX3L384QSCX	74LVX3L384MTC 74LVX3L384MTCX
See NS Package Number	M24B	MQA24	MTC24

TRI-STATE® is a registered trademark of National Semiconductor Corporation.

Absolute Maximum Ratings (Note 1)

If Military/Aerospace specified devices are required, please contact the National Semiconductor Sales Office/Distributors for availability and specifications.

Supply Voltage (V_{CC})	-0.5V to +7.0V
DC Switch Voltage (V_S)	-0.5 to +7.0V
DC Input Input Voltage (V_I) (Note 2)	-0.5 to +7.0V
DC Input Diode Current with ($V_I < 0$)	-20 mA
DC Output (I_O) Sink Current	120 mA
Storage Temperature Range (T_{STG})	-65°C to +150°C
Power Dissipation	0.5W

Note 1: The "Absolute Maximum Ratings" are those values beyond which the safety of the device cannot be guaranteed. The device should not be operated at these limits. The parametric values defined in the "Electrical Characteristics" table are not guaranteed at the absolute maximum ratings. The "Recommended Operating Conditions" table will define the conditions for actual device operation.

Note 2: The input and output negative voltage ratings may be exceeded if the input and output diode current ratings are observed.

Recommended Operating Conditions

Supply Voltage (V_{CC})	4.0V to 5.5V
Free Air Operating Temperature (T_A)	-40°C to +85°C

DC Electrical Characteristics

Symbol	Parameter	V_{CC} (V)	74LVX3L384			Units	Conditions
			$T_A = -40^\circ\text{C to } +85^\circ\text{C}$				
			Min	Typ (Note 5)	Max		
V_{IK}	Maximum Clamp Diode Voltage	4.75			-1.2	V	$I_{IN} = -18 \text{ mA}$
V_{IH}	Minimum High Level Input Voltage	4.75-5.25	2.0			V	
V_{IL}	Maximum Low Level Input Voltage	4.75-5.25			0.8		
I_{IN}	Maximum Input Leakage Current	0			10	μA	$0 \leq V_{IN} \leq 5.25\text{V}$
		5.25			± 1		
I_{OZ}	Maximum TRI-STATE® I/O Leakage	5.25			± 10	μA	$0 \leq A, B \leq V_{CC}$
I_{OS}	Short Circuit Current	4.75	100			mA	$V_I(A), V_I(B) = 0\text{V}, V_I(B), V_I(A) = 4.75\text{V}$
R_{ON}	Switch On Resistance (Note 3)	4.75		5	7	Ω	$V_I = 0\text{V}, I_{ON} = 30 \text{ mA}$
				10	15	Ω	$V_I = 2.4\text{V}, I_{ON} = 15 \text{ mA}$
I_{CC}	Maximum Quiescent Supply Current	5.25		0.2	10	μA	$V_I = V_{CC}, \text{GND } I_O = 0$
ΔI_{CC}	Increase in I_{CC} per Input (Note 4)	5.25			2.5	mA	$V_{IN} = 3.15\text{V}, I_O = 0$ Per Control Input

Note 3: Measured by voltage drop between A and B pin at indicated current through the switch. On resistance is determined by the lower of the voltages on the two (A or B) pins.

Note 4: Per TTL driven Input ($V_{IN} = 3.15\text{V}$, control inputs only). A and B pins do not contribute to I_{CC} .

Note 5: All typical values are at $V_{CC} = 5.0\text{V}, T_A = 25^\circ\text{C}$.

AC Electrical Characteristics:

Symbol	Parameter	V _{CC} (V)	74LVX3L384			Units
			T _A = -40°C to +85°C C _L = 50 pF			
			Min	Typ (Note 5)	Max	
T _{PLH} T _{PHL}	Data Propagation Delay An to Bn or Bn to An (Note 6)	4.75		0.25	ns	
T _{PZL} T _{PZH}	Switch Enable Time $\overline{BE}_A, \overline{BE}_B$ to An, Bn	4.75	1.5	6.5	ns	
T _{PLZ} T _{PHZ}	Switch Disable Time $\overline{BE}_A, \overline{BE}_B$ to An, Bn	4.75	1.5	5.5	ns	

Note 5: All typical values are at V_{CC} = 5.0V, T_A = 25°C.

Note 6: This parameter is guaranteed by design but not tested. The bus switch contributes no propagation delay other than the RC delay of the On resistance of the switch and the load capacitance. The time constant for the switch and alone is of the order of 0.25 ns for 50 pF load. Since this time constant is much smaller than the rise/fall times of typical driving signals, it adds very little propagation delay to the system. Propagation delay of the bus switch when used in a system is determined by the driving circuit on the driving side of the switch and its interaction with the load on the driven side.

Capacitance (Note)

Symbol	Parameter	Typ	Max	Units	Conditions
C _{IN}	Control Input Capacitance	4	6	pF	V _{CC} = 5.0V
C _{I/O} (OFF)	Input/Output Capacitance	9	13	pF	V _{CC} = 5.0V

Note: Capacitance is characterized but not tested.

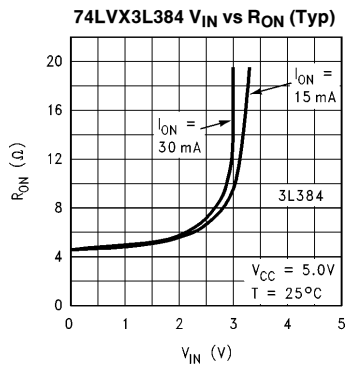

TL/F/11653-3

74LVX3L384 Ordering Information

The device number is used to form part of a simplified purchasing code where the package type and temperature range are defined as follows:

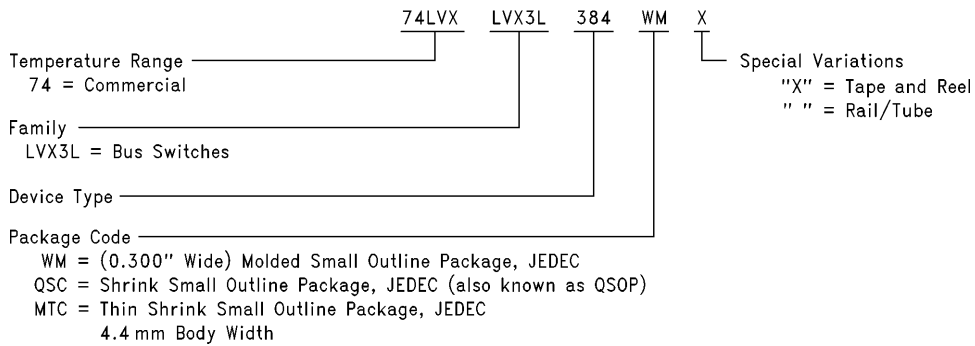

TL/F/11653-4

Physical Dimensions $\frac{\text{inches}}{\text{millimeters}}$

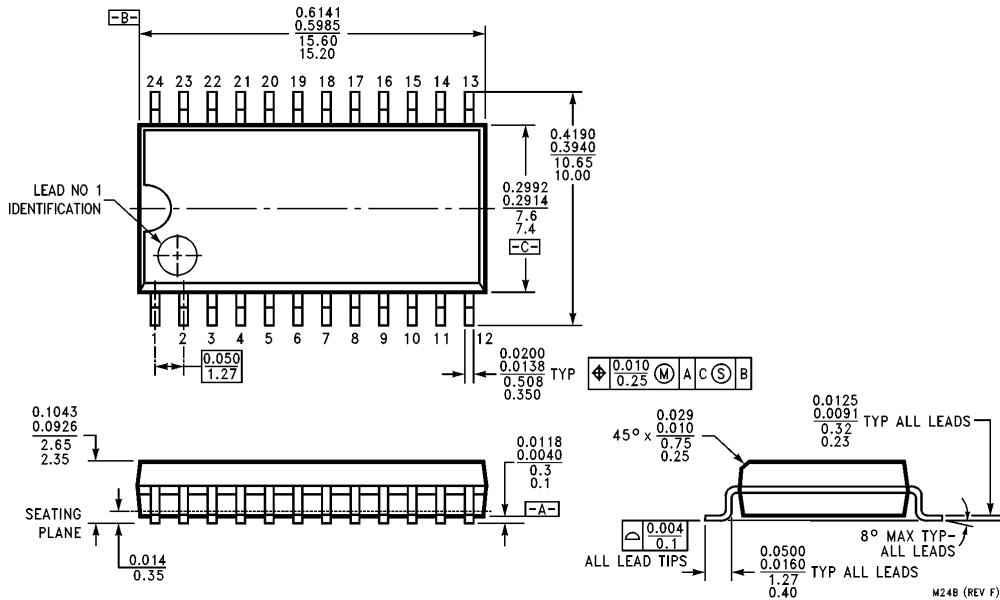

24-Lead (0.300" Wide) Small Outline Package, JEDEC
Order Number 74LVX3L384WM or 74LVX3L384WMX
NS Package Number M24B

Physical Dimensions inches (Continued)

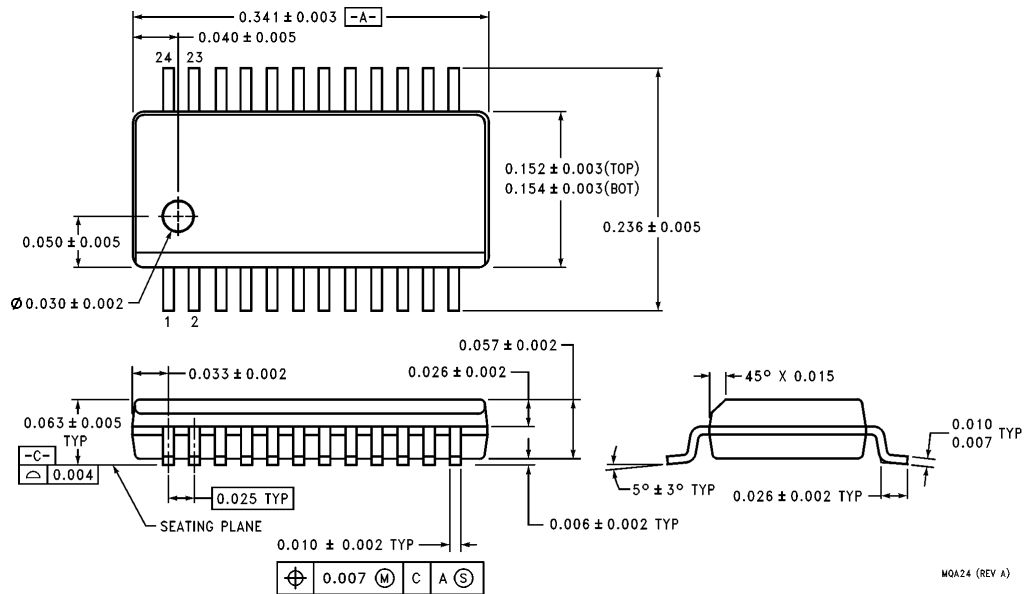

MQA24 (REV A)

24-Lead (0.150" Wide) Shrink Small Outline Package, JEDEC (QSC)
(also known as QSOP)
Order Number 74LVX3L384QSC or 74LVX3L384QSCX
NS Package Number MQA24

Physical Dimensions inches (Continued)

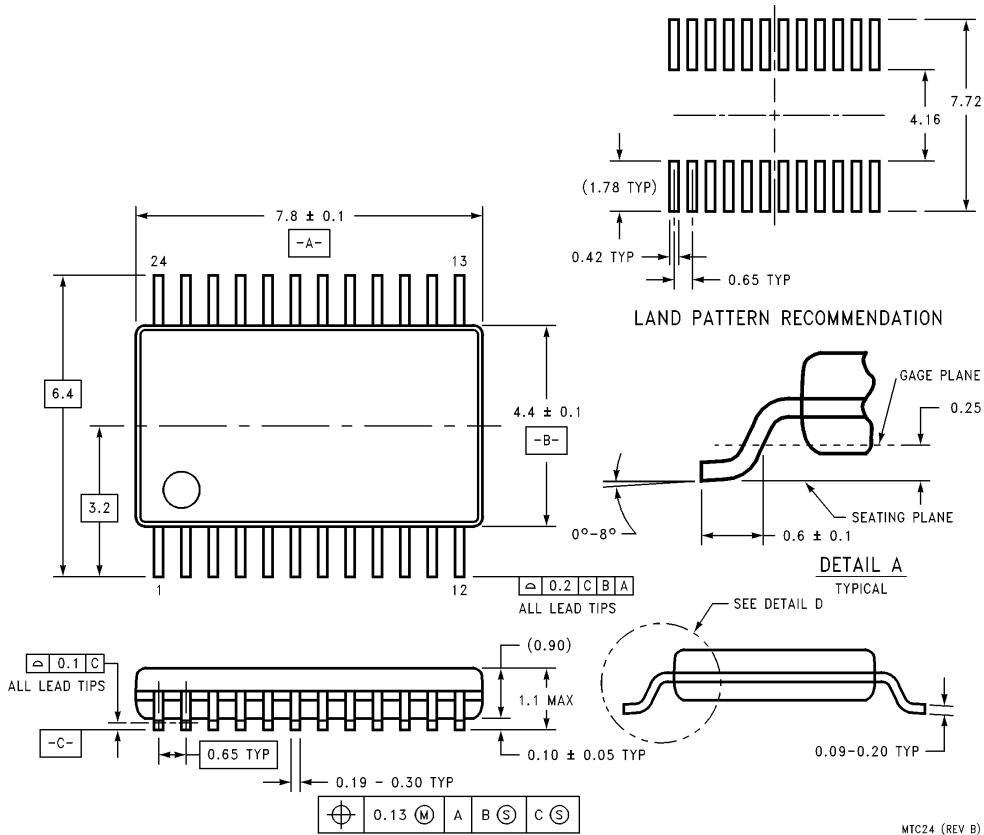

MTC24 (REV B)

24-Lead Thin Shrink Small Outline Package, JEDEC
Order Number 74LVX3L384MTC or 74LVX3L384MTCX
NS Package Number MTC24

LIFE SUPPORT POLICY

NATIONAL'S PRODUCTS ARE NOT AUTHORIZED FOR USE AS CRITICAL COMPONENTS IN LIFE SUPPORT DEVICES OR SYSTEMS WITHOUT THE EXPRESS WRITTEN APPROVAL OF THE PRESIDENT OF NATIONAL SEMICONDUCTOR CORPORATION. As used herein:

1. Life support devices or systems are devices or systems which, (a) are intended for surgical implant into the body, or (b) support or sustain life, and whose failure to perform, when properly used in accordance with instructions for use provided in the labeling, can be reasonably expected to result in a significant injury to the user.
2. A critical component is any component of a life support device or system whose failure to perform can be reasonably expected to cause the failure of the life support device or system, or to affect its safety or effectiveness.



National Semiconductor Corporation
Americas
 Tel: 1(800) 272-9959
 Fax: 1(800) 737-7018
 Email: support@nsc.com

National Semiconductor Europe
 Fax: +49 (0) 180-530 85 86
 Email: europe.support@nsc.com
 Deutsch Tel: +49 (0) 180-530 85 85
 English Tel: +49 (0) 180-532 78 32
 Français Tel: +49 (0) 180-532 93 58
 Italiano Tel: +49 (0) 180-534 16 80

National Semiconductor Southeast Asia
 Fax: (852) 2376 3901
 Email: sea.support@nsc.com

National Semiconductor Japan Ltd.
 Tel: 81-3-5620-7561
 Fax: 81-3-5620-6179

<http://www.national.com>

National does not assume any responsibility for use of any circuitry described, no circuit patent licenses are implied and National reserves the right at any time without notice to change said circuitry and specifications.

Copyright © Each Manufacturing Company.

All Datasheets cannot be modified without permission.

This datasheet has been download from :

www.AllDataSheet.com

100% Free DataSheet Search Site.

Free Download.

No Register.

Fast Search System.

www.AllDataSheet.com