

TOSHIBA CMOS Digital Integrated Circuit Silicon Monolithic

TC7WB383FK

2-Bit Bus Exchange Switch

The TC7WB383FK is a low on-resistance, high-speed CMOS 2-bit bus exchange switch. This bus switch allows the connections or disconnections to be made with minimal propagation delay while maintaining Low power dissipation which is the feature of CMOS.

When output enable (\overline{OE}) is at high level, the switches are off. When at low level, the switches are on, and by the logic of EX terminal, It can choose whether 2 bits data are transferred to the corresponding terminal as it is, or the data are transferred to a terminal with exchanging data line. Therefore it may be used as 2 to 1 multiplexer switch.

Since the switch channels consist of N type MOSFET, the high level output voltage is provided about 1 V lower than VCC level.

All inputs are equipped with protection circuits to protect the device from static discharge.

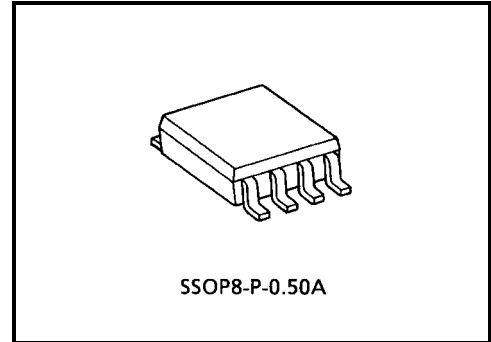

Weight: 0.01 g (typ.)

Features

- Operating voltage: VCC = 4.5~5.5 V
- High speed operation: $t_{pd} = 0.25$ ns (max)
- Ultra-low on resistance: $R_{ON} = 5 \Omega$ (typ.)
- Electro-static discharge (ESD) performance: ± 200 V or more (JEITA)
 ± 2000 V or more (MIL)
- TTL level input (control input)
- Package: US8

Pin Assignment (top view)

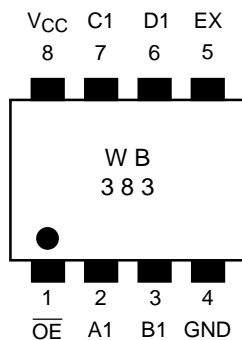

Truth Table

\overline{OE}	EX	A1	B1	C1	D1	Function
H	X	Hi-Z				Disconnect
L	L	A1 = C1, B1 = D1				Connect
L	H	A1 = D1, B1 = C1				Exchange

System Diagram

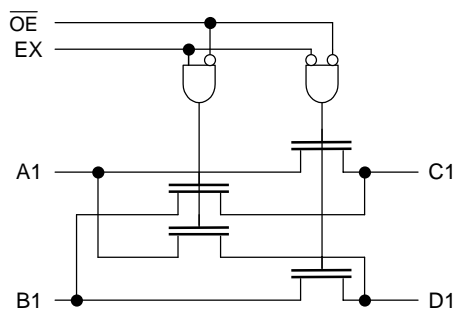

Maximum Ratings

Characteristics	Symbol	Rating	Unit
Power supply voltage	V_{CC}	-0.5~7.0	V
Control pin input voltage	V_{IN}	-0.5~7.0	V
Switch terminal I/O voltage	V_S	-0.5~7.0	V
Clump diode current	I_{IK}	-50	mA
Switch I/O current	I_S	128	mA
Power dissipation	P_D	200	mW
DC V_{CC}/GND current	I_{CC}/I_{GND}	± 100	mA
Storage temperature	T_{stg}	-65~150	$^{\circ}C$

Recommended Operating Conditions

Characteristics	Symbol	Rating	Unit
Power supply voltage	V_{CC}	4.5~5.5	V
Control pin input voltage	V_{IN}	0~5.5	V
Switch I/O voltage	V_S	0~5.5	V
Operating temperature	T_{opr}	-40~85	$^{\circ}C$
Control pin input rise/fall time	dt/dv	0~10	ns/V

Electrical Characteristics

DC Characteristics (Ta = -40~85°C)

Characteristics		Symbol	Test Condition	V _{CC} (V)	Min	Typ. (Note 1)	Max	Unit
Control pin input voltage	"H" level	V _{IH}	—	4.5~5.5	2.0	—	—	V
	"L" level	V _{IL}	—	4.5~5.5	—	—	0.8	
Input leakage current		I _{IN}	V _{IN} = 0~5.5 V	4.5~5.5	—	—	±1.0	μA
Power off leakage current		I _{OFF}	A, B, \overline{OE} = 0~5.5 V	0	—	—	±1.0	μA
Off-state leakage current (switch off)		I _{SZ}	A, B = 0~5.5 V, \overline{OE} = V _{CC}	4.5~5.5	—	—	±1.0	μA
ON resistance (Note 2)	R _{ON}	V _{IS} = 0 V	I _{IS} = 64 mA	4.5	—	5	7	Ω
			I _{IS} = 30 mA	4.5	—	5	7	
		V _{IS} = 2.4 V, I _{IS} = 15 mA		4.5	—	10	15	
Quiescent supply current		I _{CC}	V _{IN} = V _{CC} or GND I _{OUT} = 0	5.5	—	—	10	mA
		ΔI _{CC}	V _{IN} = 3.4 V (one input)	5.5	—	—	2.5	mA

Note 1: The typical values are at V_{CC} = 5 V, Ta = 25°C.

Note 2: Measured by the voltage drop between A and B pins at the indicated current through the switch. On resistance is determined by the lower of the voltages on two (A or B) pins.

AC Characteristics (Ta = -40~85°C)

Characteristics		Symbol	Test Condition	V _{CC} (V)	Min	Max	Unit
Propagation delay time (bus to bus)		t _{pLH} t _{pHL}	Figure 1, Figure 2 (Note 3)	4.5	—	0.25	ns
Propagation delay time (EX to bus)		t _{pLH} t _{pHL}	Figure 1, Figure 3	4.5	—	4.5	ns
Output enable time		t _{pZL} t _{pZH}	Figure 1, Figure 4	4.5	—	4.5	ns
Output disable time		t _{pLZ} t _{pHZ}	Figure 1, Figure 4	4.5	—	5.5	ns

Note 3: This parameter is guaranteed by design but is not tested. The bus switch contributes no propagation delay other than the RC delay of the typical on resistance of the switch and the 50 pF load capacitance, when driven by an ideal voltage the source (zero output impedance).

Capacitive Characteristics (Ta = 25°C)

Characteristics	Symbol	Test Condition	V _{CC} (V)	Typ.	Unit
Control pin input capacitance	C _{IN}	(Note 4)	5.0	3	pF
Switch terminal capacitance	C _{I/O}	\overline{OE} = V _{CC} (Note 4)	5.0	17	pF

Note 4: This item is guaranteed by design.

AC Test Circuit

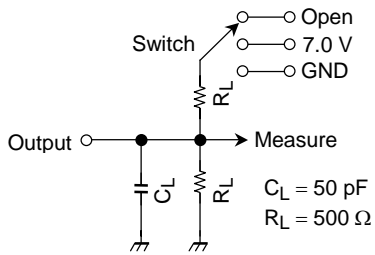

Parameter	Switch
t_{pLH} , t_{pHL}	Open
t_{pLZ} , t_{pZL}	7.0 V
t_{pHZ} , t_{pZH}	Open

Figure 1

AC Waveform

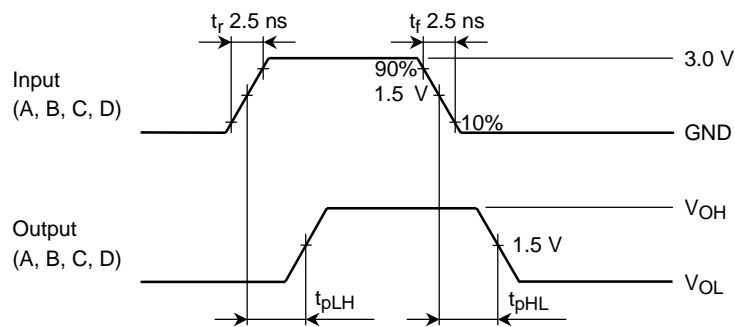

Figure 2 t_{pLH} , t_{pHL}

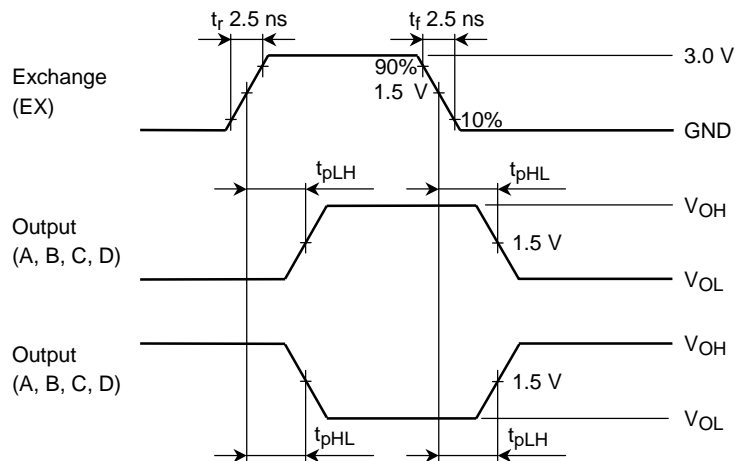
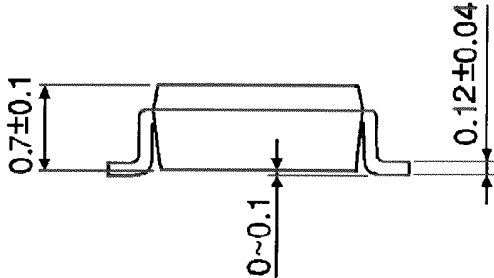
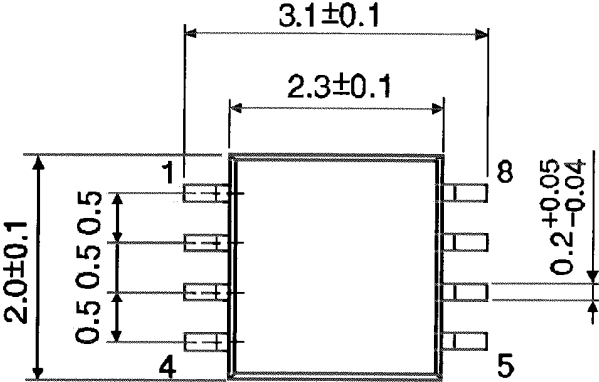

Figure 3 t_{pLH} , t_{pHL}

Package Dimensions

SSOP8-P-0.50A

Unit : mm



Weight: 0.01 g (typ.)

RESTRICTIONS ON PRODUCT USE

000707EBA

- TOSHIBA is continually working to improve the quality and reliability of its products. Nevertheless, semiconductor devices in general can malfunction or fail due to their inherent electrical sensitivity and vulnerability to physical stress. It is the responsibility of the buyer, when utilizing TOSHIBA products, to comply with the standards of safety in making a safe design for the entire system, and to avoid situations in which a malfunction or failure of such TOSHIBA products could cause loss of human life, bodily injury or damage to property.
In developing your designs, please ensure that TOSHIBA products are used within specified operating ranges as set forth in the most recent TOSHIBA products specifications. Also, please keep in mind the precautions and conditions set forth in the "Handling Guide for Semiconductor Devices," or "TOSHIBA Semiconductor Reliability Handbook" etc..
- The TOSHIBA products listed in this document are intended for usage in general electronics applications (computer, personal equipment, office equipment, measuring equipment, industrial robotics, domestic appliances, etc.). These TOSHIBA products are neither intended nor warranted for usage in equipment that requires extraordinarily high quality and/or reliability or a malfunction or failure of which may cause loss of human life or bodily injury ("Unintended Usage"). Unintended Usage include atomic energy control instruments, airplane or spaceship instruments, transportation instruments, traffic signal instruments, combustion control instruments, medical instruments, all types of safety devices, etc.. Unintended Usage of TOSHIBA products listed in this document shall be made at the customer's own risk.
- The products described in this document are subject to the foreign exchange and foreign trade laws.
- The information contained herein is presented only as a guide for the applications of our products. No responsibility is assumed by TOSHIBA CORPORATION for any infringements of intellectual property or other rights of the third parties which may result from its use. No license is granted by implication or otherwise under any intellectual property or other rights of TOSHIBA CORPORATION or others.
- The information contained herein is subject to change without notice.