

查询 TLV2460QPWRQ1 供 TLV2460A-Q1, TLV2461A-Q1, TLV2462A-Q1, TLV2463A-Q1, TLV2464A-Q1
FAMILY OF LOW-POWER RAIL-TO-RAIL INPUT/OUTPUT OPERATIONAL AMPLIFIERS WITH SHUTDOWN

SGLS008B – MARCH 2003 – REVISED MAY 2004

- Qualification in Accordance With AEC-Q100†
- Qualified for Automotive Applications
- Customer-Specific Configuration Control Can Be Supported Along With Major-Change Approval
- ESD Protection Exceeds 2000 V Per MIL-STD-883, Method 3015; Exceeds 200 V Using Machine Model (C = 200 pF, R = 0)
- Rail-to-Rail Output Swing
- Gain Bandwidth Product . . . 6.4 MHz
- ±80 mA Output Drive Capability
- Supply Current . . . 500 μ A/channel
- Input Offset Voltage . . . 100 μ V
- Input Noise Voltage . . . 11 nV/ $\sqrt{\text{Hz}}$
- Slew Rate . . . 1.6 V/ μ s
- Micropower Shutdown Mode (TLV2460/3/5) . . . 0.3 μ A/Channel
- Universal Operational Amplifier EVM

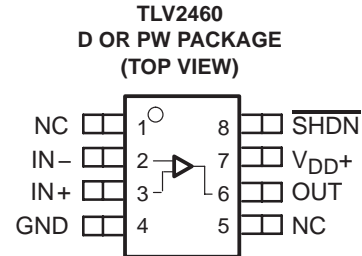

† Contact factory for details. Q100 qualification data available on request.

description

The TLV246x is a family of low-power rail-to-rail input/output operational amplifiers specifically designed for portable applications. The input common-mode voltage range extends beyond the supply rails for maximum dynamic range in low-voltage systems. The amplifier output has rail-to-rail performance with high-output-drive capability, solving one of the limitations of older rail-to-rail input/output operational amplifiers. This rail-to-rail dynamic range and high output drive make the TLV246x ideal for buffering analog-to-digital converters.

The operational amplifier has 6.4 MHz of bandwidth and 1.6 V/ μ s of slew rate with only 500 μ A of supply current, providing good ac performance with low power consumption. Devices are available with an optional shutdown terminal, which places the amplifier in an ultralow supply current mode ($I_{DD} = 0.3 \mu\text{A}/\text{ch}$). While in shutdown, the operational-amplifier output is placed in a high-impedance state. DC applications are also well served with an input noise voltage of 11 nV/ $\sqrt{\text{Hz}}$ and input offset voltage of 100 μ V.

ORDERING INFORMATION‡

T _A	PACKAGE		ORDERABLE PART NUMBER§	TOP-SIDE MARKING
-40°C to 125°C	SOP – D	Tape and reel	TLV2464AQDRQ1	V2464AQ1
-40°C to 125°C	TSSOP – PW	Tape and reel	TLV2464AQPWRQ1	V2464AQ

‡ Package drawings, standard packing quantities, thermal data, symbolization, and PCB design guidelines are available at www.ti.com/sc/package.

§ All other device/package combinations are Product Preview.



Please be aware that an important notice concerning availability, standard warranty, and use in critical applications of Texas Instruments semiconductor products and disclaimers thereto appears at the end of this data sheet.

PRODUCTION DATA information is current as of publication date. Products conform to specifications per the terms of Texas Instruments standard warranty. Production processing does not necessarily include testing of all parameters.



POST OFFICE BOX 655303 • DALLAS, TEXAS 75265

Copyright © 2003 – 2004 Texas Instruments Incorporated

TLV2460A-Q1, TLV2461A-Q1, TLV2462A-Q1, TLV2463A-Q1, TLV2464A-Q1 FAMILY OF LOW-POWER RAIL-TO-RAIL INPUT/OUTPUT OPERATIONAL AMPLIFIERS WITH SHUTDOWN

SGLS008B – MARCH 2003 – REVISED MAY 2004

TLV246x PACKAGE PINOUTS

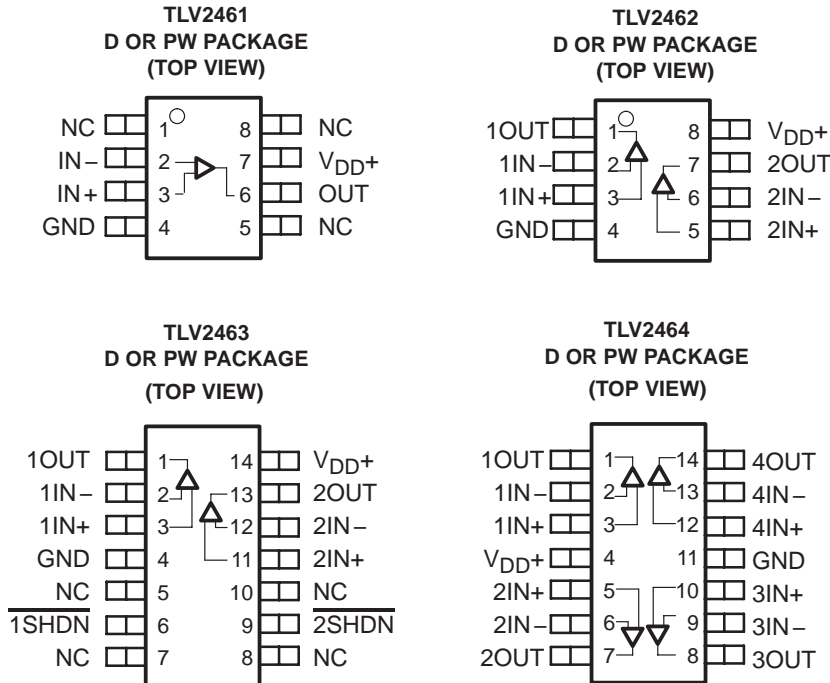

NC – No internal connection

TLV2460A-Q1, TLV2461A-Q1, TLV2462A-Q1, TLV2463A-Q1, TLV2464A-Q1
FAMILY OF LOW-POWER RAIL-TO-RAIL INPUT/OUTPUT
OPERATIONAL AMPLIFIERS WITH SHUTDOWN

SGLS008B – MARCH 2003 – REVISED MAY 2004

absolute maximum ratings over operating free-air temperature range (unless otherwise noted)†

Supply voltage, V_{DD} (see Note 1)	6 V
Differential input voltage, V_{ID}	– 0.2 V to $V_{DD} + 0.2$ V
Input current, I_I (any input)	± 200 mA
Output current, I_O	± 175 mA
Total input current, I_I (into V_{DD+})	175 mA
Total output current, I_O (out of GND)	175 mA
Continuous total power dissipation	See Dissipation Rating Table
Operating free-air temperature range, T_A	–40°C to 125°C
Maximum junction temperature, T_J	150°C
Thermal resistance, Junction-to-Ambient, Θ_{JA} :	D (8) 176°C/W
	D (14) 123°C/W
	D (16) 115°C/W
	PW (14) 174°C/W
Storage temperature range, T_{stg}	–65°C to 150°C
Lead temperature 1,6 mm (1/16 inch) from case for 10 seconds	260°C

† Stresses beyond those listed under “absolute maximum ratings” may cause permanent damage to the device. These are stress ratings only, and functional operation of the device at these or any other conditions beyond those indicated under “recommended operating conditions” is not implied. Exposure to absolute-maximum-rated conditions for extended periods may affect device reliability.

NOTE 1: All voltage values, except differential voltages, are with respect to GND.

recommended operating conditions

		MIN	MAX	UNIT
Supply voltage, V_{DD}	Single supply	2.7	6	V
	Split supply	± 1.35	± 3	
Common-mode input voltage range, V_{ICR}		–0.2	$V_{DD} + 0.2$	V
Operating free-air temperature, T_A		–40	125	°C
Shutdown on/off voltage level‡	V_{IH}	2		V
	V_{IL}	0.7		

‡ Relative to voltage on the GND terminal of the device.



TLV2460A-Q1, TLV2461A-Q1, TLV2462A-Q1, TLV2463A-Q1, TLV2464A-Q1
FAMILY OF LOW-POWER RAIL-TO-RAIL INPUT/OUTPUT
OPERATIONAL AMPLIFIERS WITH SHUTDOWN

SGLS008B – MARCH 2003 – REVISED MAY 2004

electrical characteristics at specified free-air temperature, $V_{DD} = 3\text{ V}$ (unless otherwise noted)

PARAMETER		TEST CONDITIONS	T_A †	MIN	TYP	MAX	UNIT
V_{IO}	Input offset voltage	$V_{DD} = 3\text{ V}$, $V_O = 1.5\text{ V}$	$V_{IC} = 1.5\text{ V}$, $R_S = 50\ \Omega$	25°C	150	1500	μV
				Full range		1700	
α_{VIO}	Temperature coefficient of input offset voltage				2		$\mu\text{V}/^\circ\text{C}$
I_{IO}	Input offset current	$V_{DD} = 3\text{ V}$, $V_O = 1.5\text{ V}$	$V_{IC} = 1.5\text{ V}$, $R_S = 50\ \Omega$	25°C	2.8	7	nA
				Full range		75	
I_{IB}	Input bias current	$V_{DD} = 3\text{ V}$, $V_O = 1.5\text{ V}$	$V_{IC} = 1.5\text{ V}$, $R_S = 50\ \Omega$	25°C	4.4	14	nA
				Full range		75	
V_{OH}	High-level output voltage	$I_{OH} = -2.5\text{ mA}$		25°C	2.9		V
				Full range		2.8	
		$I_{OH} = -10\text{ mA}$		25°C	2.7		
				Full range		2.5	
V_{OL}	Low-level output voltage	$V_{IC} = 1.5\text{ V}$, $I_{OL} = 2.5\text{ mA}$		25°C	0.1	0.2	V
				Full range		0.2	
		$V_{IC} = 1.5\text{ V}$, $I_{OL} = 10\text{ mA}$		25°C	0.3		
				Full range		0.5	
I_{OS}	Short-circuit output current	Sourcing		25°C	50		mA
				Full range		20	
		Sinking		25°C	40		
				Full range		20	
I_O	Output current	Measured 1 V from rail		25°C	± 40		mA
A_{VD}	Large-signal differential voltage amplification	$R_L = 10\text{ k}\Omega$		25°C	90	105	dB
				Full range		89	
$r_{i(d)}$	Differential input resistance			25°C	10^9		Ω
$c_{i(c)}$	Common-mode input capacitance	$f = 10\text{ kHz}$		25°C	7		pF
z_o	Closed-loop output impedance	$f = 100\text{ kHz}$, $A_V = 10$		25°C	33		Ω
CMRR	Common-mode rejection ratio	$V_{ICR} = 0\text{ V to }3\text{ V}$, $R_S = 50\ \Omega$		25°C	66	80	dB
				Full range		60	
k_{SVR}	Supply voltage rejection ratio ($\Delta V_{DD} / \Delta V_{IO}$)	$V_{DD} = 2.7\text{ V to }6\text{ V}$, No load	$V_{IC} = V_{DD}/2$	25°C	80	85	dB
				Full range		75	
		$V_{DD} = 3\text{ V to }5\text{ V}$, No load	$V_{IC} = V_{DD}/2$	25°C	85	95	
				Full range		80	
I_{DD}	Supply current (per channels)	$V_O = 1.5\text{ V}$, No load		25°C	0.5	0.575	mA
				Full range		0.9	
$I_{DD(SHDN)}$	Supply current in shutdown (TLV2460, TLV2463)	$SHDN < 0.7\text{ V}$, Per channel in shutdown		25°C	0.3		μA
				Full range		2.5	

† Full range is -40°C to 125°C for the Q suffix.



TLV2460A-Q1, TLV2461A-Q1, TLV2462A-Q1, TLV2463A-Q1, TLV2464A-Q1
FAMILY OF LOW-POWER RAIL-TO-RAIL INPUT/OUTPUT
OPERATIONAL AMPLIFIERS WITH SHUTDOWN

SGLS008B – MARCH 2003 – REVISED MAY 2004

operating characteristics at specified free-air temperature, $V_{DD} = 3\text{ V}$ (unless otherwise noted)

PARAMETER		TEST CONDITIONS		T_A †	MIN	TYP	MAX	UNIT	
SR	Slew rate at unity gain	$V_{O(PP)} = 2\text{ V}$, $R_L = 10\text{ k}\Omega$	$C_L = 160\text{ pF}$	25°C	1	1.6		V/ μs	
				Full range	0.8				
V_n	Equivalent input noise voltage			25°C	16			nV/ $\sqrt{\text{Hz}}$	
				25°C	11				
I_n	Equivalent input noise current	$f = 1\text{ kHz}$		25°C	0.13		pA/ $\sqrt{\text{Hz}}$		
THD + N	Total harmonic distortion plus noise	$V_{O(PP)} = 2\text{ V}$, $R_L = 10\text{ k}\Omega$, $f = 1\text{ kHz}$		25°C	$A_V = 1$	0.006%			
					$A_V = 10$	0.02%			
					$A_V = 100$	0.08%			
$t_{(on)}$	Amplifier turnon time	$A_V = 1$, $R_L = 10\text{ k}\Omega$		25°C	Both channels	7.6		μs	
					Channel 1 only, Channel 2 on	7.65			
$t_{(off)}$	Amplifier turnoff time	$A_V = 1$, $R_L = 10\text{ k}\Omega$		25°C	Both channels	333		ns	
					Channel 1 only, Channel 2 on	328			
					Channel 2 only, Channel 1 on	329			
Gain-bandwidth product		$f = 10\text{ kHz}$, $C_L = 160\text{ pF}$	$R_L = 10\text{ k}\Omega$	25°C	5.2		MHz		
t_s	Settling time	$V_{(STEP)PP} = 2\text{ V}$, $A_V = -1$, $C_L = 10\text{ pF}$, $R_L = 10\text{ k}\Omega$		25°C	0.1%	1.47		μs	
					0.01%	1.78			
					$V_{(STEP)PP} = 2\text{ V}$, $A_V = -1$, $C_L = 56\text{ pF}$, $R_L = 10\text{ k}\Omega$	0.1%	1.77		
					0.01%	1.98			
ϕ_m	Phase margin at unity gain	$R_L = 10\text{ k}\Omega$, $C_L = 160\text{ pF}$		25°C	44°				
	Gain margin			25°C	7		dB		

† Full range is -40°C to 125°C for the Q suffix.

TLV2460A-Q1, TLV2461A-Q1, TLV2462A-Q1, TLV2463A-Q1, TLV2464A-Q1
FAMILY OF LOW-POWER RAIL-TO-RAIL INPUT/OUTPUT
OPERATIONAL AMPLIFIERS WITH SHUTDOWN

SGLS008B – MARCH 2003 – REVISED MAY 2004

electrical characteristics at specified free-air temperature, $V_{DD} = 5\text{ V}$ (unless otherwise noted)

PARAMETER		TEST CONDITIONS	T_A^\dagger	MIN	TYP	MAX	UNIT
V_{IO}	Input offset voltage	$V_{DD} = 5\text{ V}$, $V_O = 2.5\text{ V}$	$V_{IC} = 2.5\text{ V}$, $R_S = 50\ \Omega$	25°C	150	1500	μV
				Full range		1700	
α_{VIO}	Temperature coefficient of input offset voltage		25°C		2		$\mu\text{V}/^\circ\text{C}$
I_{IO}	Input offset current	$V_{DD} = 5\text{ V}$, $V_O = 2.5\text{ V}$	$V_{IC} = 2.5\text{ V}$, $R_S = 50\ \Omega$	25°C	0.3	7	nA
				Full range		60	
I_{IB}	Input bias current	$V_{DD} = 5\text{ V}$, $V_O = 2.5\text{ V}$	$V_{IC} = 2.5\text{ V}$, $R_S = 50\ \Omega$	25°C	1.3	14	nA
				Full range		60	
V_{OH}	High-level output voltage	$I_{OH} = -2.5\text{ mA}$		25°C		4.9	V
				Full range		4.8	
		$I_{OH} = -10\text{ mA}$		25°C		4.8	
				Full range		4.7	
V_{OL}	Low-level output voltage	$V_{IC} = 2.5\text{ V}$, $I_{OL} = 2.5\text{ mA}$		25°C		0.1	V
				Full range		0.2	
		$V_{IC} = 2.5\text{ V}$, $I_{OL} = 10\text{ mA}$		25°C		0.2	
				Full range		0.3	
I_{OS}	Short-circuit output current	Sourcing		25°C		145	mA
				Full range		60	
		Sinking		25°C		100	
				Full range		60	
I_O	Output current	Measured at 1 V from rail		25°C		± 80	mA
A_{VD}	Large-signal differential voltage amplification	$V_{IC} = 2.5\text{ V}$, $V_O = 1\text{ V to }4\text{ V}$	$R_L = 10\text{ k}\Omega$	25°C	92	109	dB
				Full range		90	
$r_{i(d)}$	Differential input resistance			25°C		10^9	Ω
$c_{i(c)}$	Common-mode input capacitance	$f = 10\text{ kHz}$		25°C		7	pF
z_o	Closed-loop output impedance	$f = 100\text{ kHz}$, $A_V = 10$		25°C		29	Ω
CMRR	Common-mode rejection ratio	$V_{ICR} = 0\text{ V to }5\text{ V}$, $R_S = 50\ \Omega$		25°C	71	85	dB
				Full range		60	
k_{SVR}	Supply voltage rejection ratio ($\Delta V_{DD} / \Delta V_{IO}$)	$V_{DD} = 2.7\text{ V to }6\text{ V}$, No load,	$V_{IC} = V_{DD}/2$	25°C	80	85	dB
				Full range		75	
		$V_{DD} = 3\text{ V to }5\text{ V}$, No load,	$V_{IC} = V_{DD}/2$	25°C	85	95	dB
				Full range		80	
I_{DD}	Supply current (per channel)	$V_O = 2.5\text{ V}$, No load,		25°C	0.55	0.65	mA
				Full range		1	
$I_{DD(SHDN)}$	Supply current in shutdown (TLV2460, TLV2463)	$SHDN < 0.7\text{ V}$, Per channels in shutdown		25°C		1	μA
				Full range		3	

† Full range is -40°C to 125°C for the Q suffix.



TLV2460A-Q1, TLV2461A-Q1, TLV2462A-Q1, TLV2463A-Q1, TLV2464A-Q1
FAMILY OF LOW-POWER RAIL-TO-RAIL INPUT/OUTPUT
OPERATIONAL AMPLIFIERS WITH SHUTDOWN

SGLS008B – MARCH 2003 – REVISED MAY 2004

operating characteristics at specified free-air temperature, $V_{DD} = 5\text{ V}$ (unless otherwise noted)

PARAMETER		TEST CONDITIONS		T_A †	MIN	TYP	MAX	UNIT
SR	Slew rate at unity gain	$V_{O(PP)} = 2\text{ V}$, $R_L = 10\text{ k}\Omega$	$C_L = 160\text{ pF}$	25°C	1	1.6		V/ μs
				Full range	0.8			
V_n	Equivalent input noise voltage	$f = 100\text{ Hz}$		25°C	14			nV/ $\sqrt{\text{Hz}}$
		$f = 1\text{ kHz}$		25°C	11			
I_n	Equivalent input noise current	$f = 100\text{ Hz}$		25°C	0.13			pA/ $\sqrt{\text{Hz}}$
THD + N	Total harmonic distortion plus noise	$V_{O(PP)} = 4\text{ V}$, $R_L = 10\text{ k}\Omega$, $f = 10\text{ kHz}$		25°C	$A_V = 1$	0.004%		
					$A_V = 10$	0.01%		
					$A_V = 100$	0.04%		
$t_{(on)}$	Amplifier turnon time	$A_V = 1$, $R_L = 10\text{ k}\Omega$		25°C	Both channels	7.6		μs
					Channel 1 only, Channel 2 on	7.65		
					Channel 2 only, Channel 1 on	7.25		
$t_{(off)}$	Amplifier turnoff time	$A_V = 1$, $R_L = 10\text{ k}\Omega$		25°C	Both channels	333		ns
					Channel 1 only, Channel 2 on	328		
					Channel 2 only, Channel 1 on	329		
Gain-bandwidth product		$f = 10\text{ kHz}$, $C_L = 160\text{ pF}$	$R_L = 10\text{ k}\Omega$,	25°C	6.4			MHz
t_s	Settling time	$V_{(STEP)PP} = 2\text{ V}$, $A_V = -1$, $C_L = 10\text{ pF}$, $R_L = 10\text{ k}\Omega$		25°C	0.1%	1.53		μs
					0.01%	1.83		
		$V_{(STEP)PP} = 2\text{ V}$, $A_V = -1$, $C_L = 56\text{ pF}$, $R_L = 10\text{ k}\Omega$			0.1%	3.13		
					0.01%	3.33		
ϕ_m	Phase margin at unity gain	$R_L = 10\text{ k}\Omega$,	$C_L = 160\text{ pF}$	25°C	45°			
Gain margin				25°C	7			dB

† Full range is -40°C to 125°C for the Q suffix.

TLV2460A-Q1, TLV2461A-Q1, TLV2462A-Q1, TLV2463A-Q1, TLV2464A-Q1
FAMILY OF LOW-POWER RAIL-TO-RAIL INPUT/OUTPUT
OPERATIONAL AMPLIFIERS WITH SHUTDOWN

SGLS008B – MARCH 2003 – REVISED MAY 2004

TYPICAL CHARACTERISTICS

Table of Graphs

			FIGURE
V_{IO}	Input offset voltage	vs Common-mode input voltage	1, 2
I_{IB}	Input bias current	vs Free-air temperature	3, 4
I_{IO}	Input offset current	vs Free-air temperature	3, 4
V_{OH}	High-level output voltage	vs High-level output current	5, 6
V_{OL}	Low-level output voltage	vs Low-level output current	7, 8
$V_{O(PP)}$	Peak-to-peak output voltage	vs Frequency	9, 10
	Open-loop gain	vs Frequency	11, 12
	Phase	vs Frequency	11, 12
A_{VD}	Differential voltage amplification	vs Load resistance	13
	Capacitive load	vs Load resistance	14
Z_o	Output impedance	vs Frequency	15, 16
CMRR	Common-mode rejection ratio	vs Frequency	17
kSVR	Supply-voltage rejection ratio	vs Frequency	18, 19
I_{DD}	Supply current	vs Supply voltage	20
		vs Free-air temperature	21
	Amplifier turnon characteristics		22
	Amplifier turnoff characteristics		23
	Supply current turnon		24
	Supply current turnoff		25
	Shutdown supply current	vs Free-air temperature	26
SR	Slew rate	vs Supply voltage	27
V_n	Equivalent input noise voltage	vs Frequency	28, 29
		vs Common-mode input voltage	30, 31
THD	Total harmonic distortion	vs Frequency	32, 33
THD+N	Total harmonic distortion plus noise	vs Peak-to-peak signal amplitude	34, 35
ϕ_m	Phase margin	vs Frequency	11, 12
		vs Load capacitance	36
		vs Free-air temperature	37
	Gain bandwidth product	vs Supply voltage	38
		vs Free-air temperature	39
	Large signal follower		40, 41
	Small signal follower		42, 43
	Inverting large signal		44, 45
	Inverting small signal		46, 47



TLV2460A-Q1, TLV2461A-Q1, TLV2462A-Q1, TLV2463A-Q1, TLV2464A-Q1
 FAMILY OF LOW-POWER RAIL-TO-RAIL INPUT/OUTPUT
 OPERATIONAL AMPLIFIERS WITH SHUTDOWN

SGLS008B – MARCH 2003 – REVISED MAY 2004

TYPICAL CHARACTERISTICS

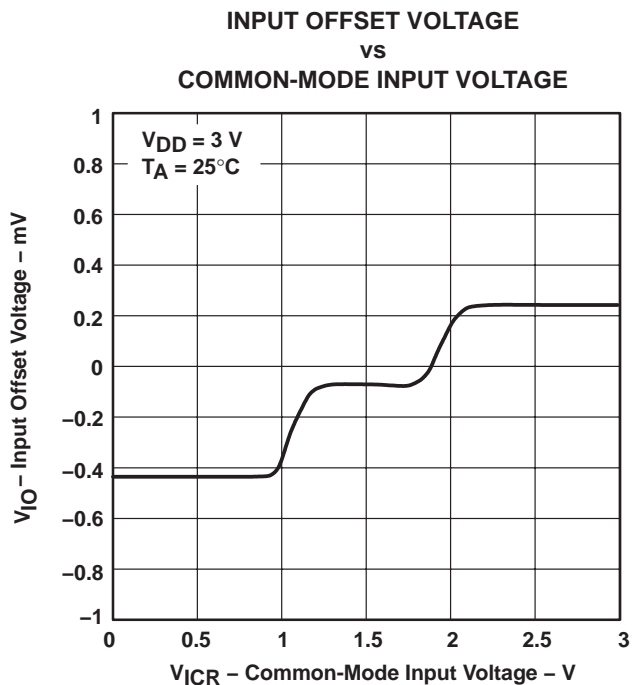

Figure 1

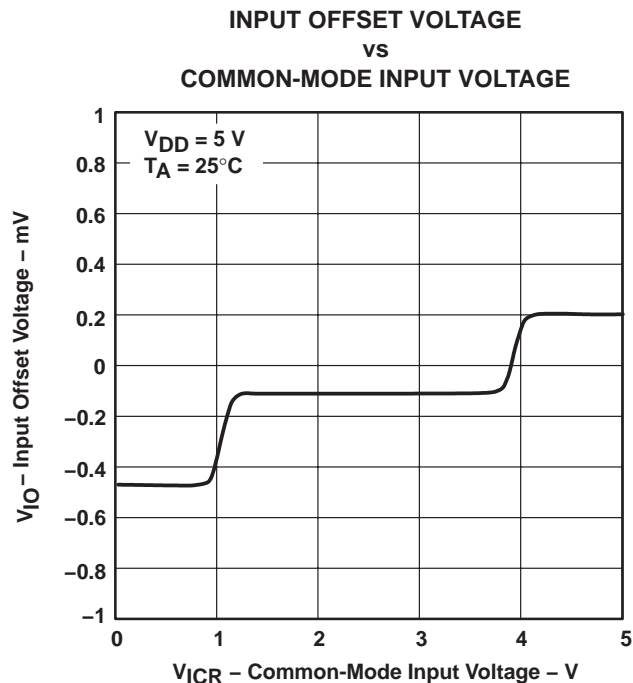

Figure 2

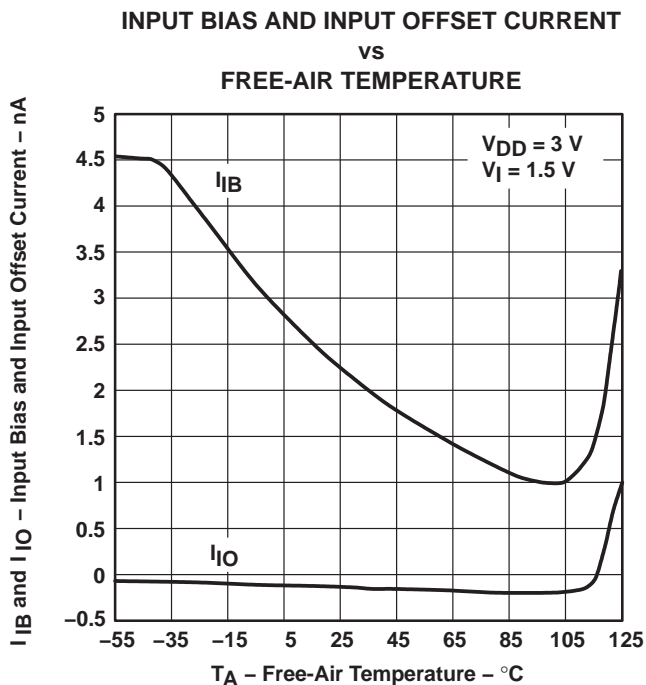

Figure 3

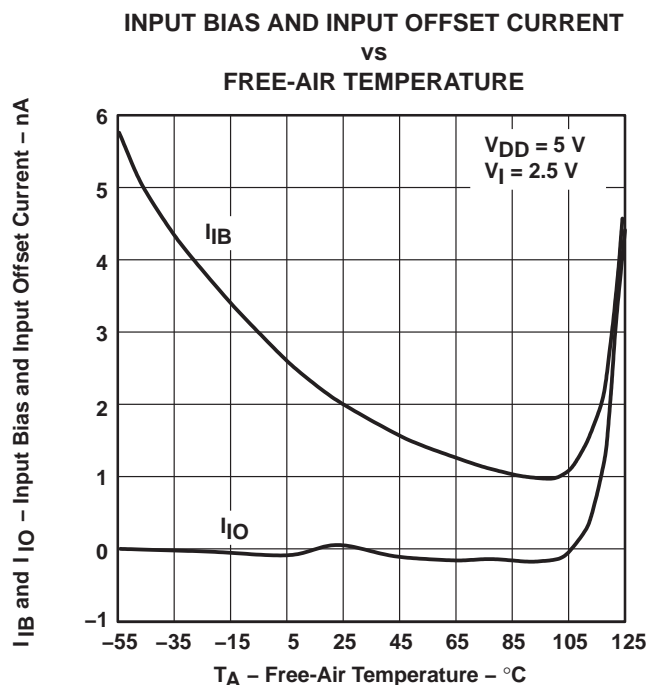

Figure 4

TLV2460A-Q1, TLV2461A-Q1, TLV2462A-Q1, TLV2463A-Q1, TLV2464A-Q1
FAMILY OF LOW-POWER RAIL-TO-RAIL INPUT/OUTPUT
OPERATIONAL AMPLIFIERS WITH SHUTDOWN

SGLS008B – MARCH 2003 – REVISED MAY 2004

TYPICAL CHARACTERISTICS

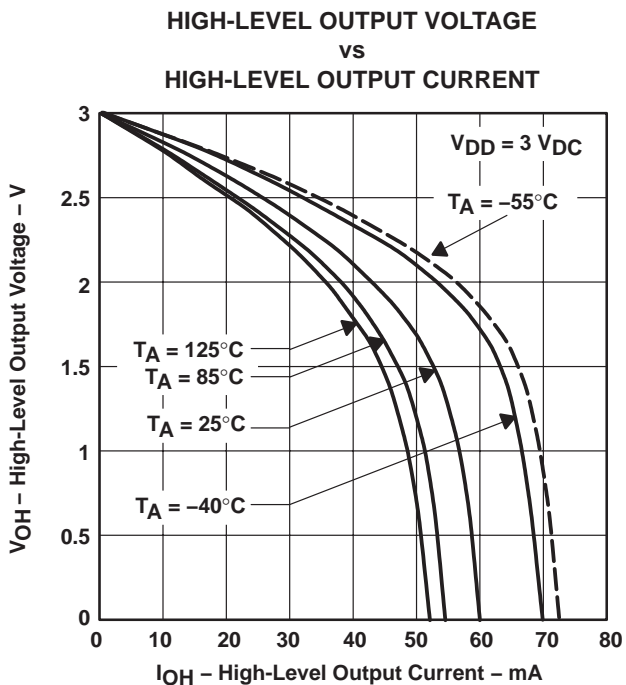

Figure 5

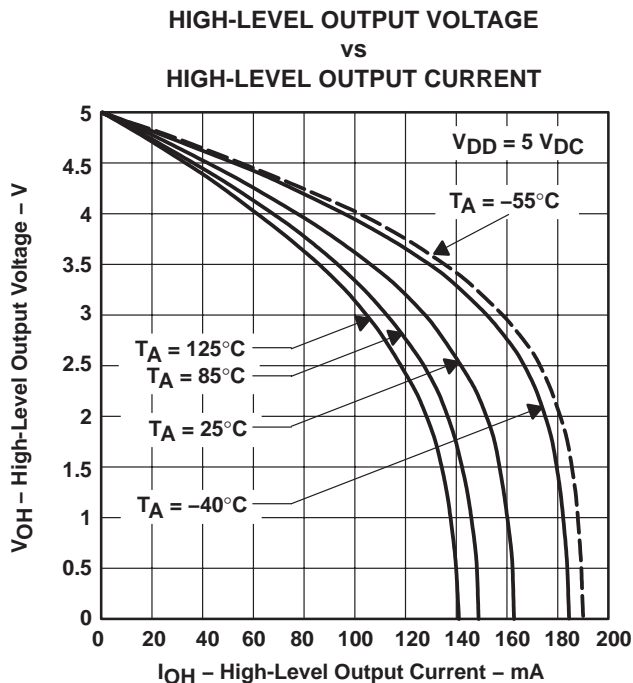

Figure 6

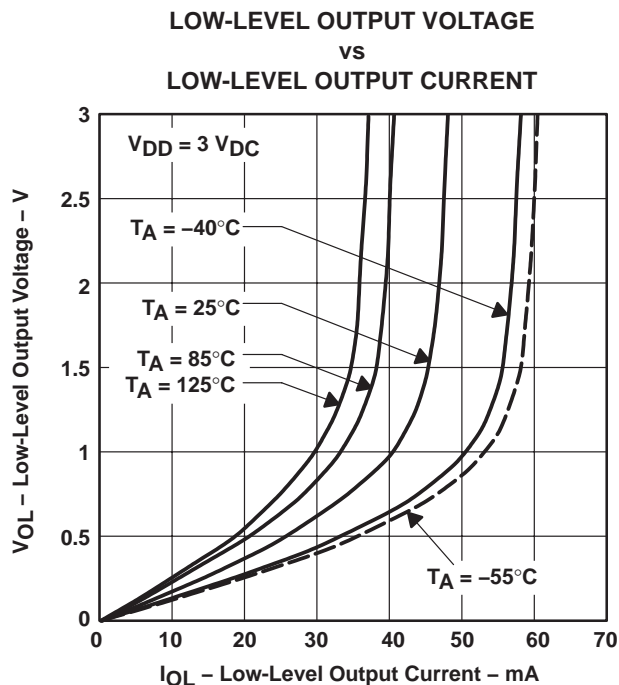

Figure 7

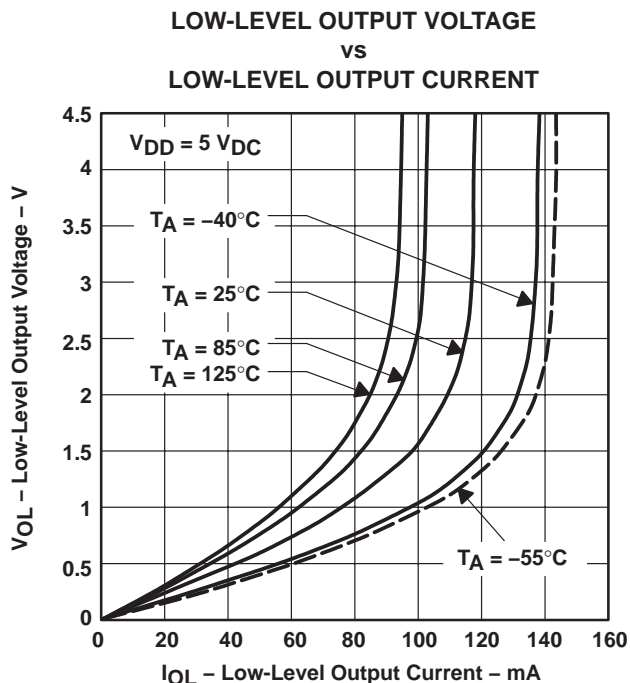

Figure 8



TLV2460A-Q1, TLV2461A-Q1, TLV2462A-Q1, TLV2463A-Q1, TLV2464A-Q1
 FAMILY OF LOW-POWER RAIL-TO-RAIL INPUT/OUTPUT
 OPERATIONAL AMPLIFIERS WITH SHUTDOWN

SGLS008B – MARCH 2003 – REVISED MAY 2004

TYPICAL CHARACTERISTICS

PEAK-TO-PEAK OUTPUT VOLTAGE
 VS
 FREQUENCY

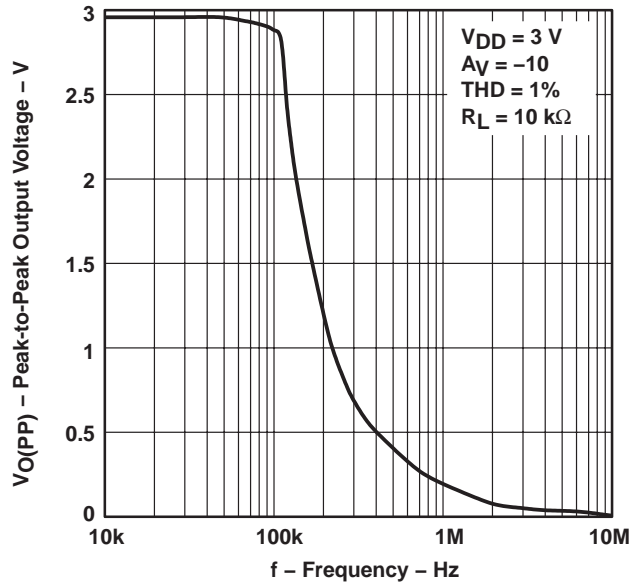

Figure 9

PEAK-TO-PEAK OUTPUT VOLTAGE
 VS
 FREQUENCY

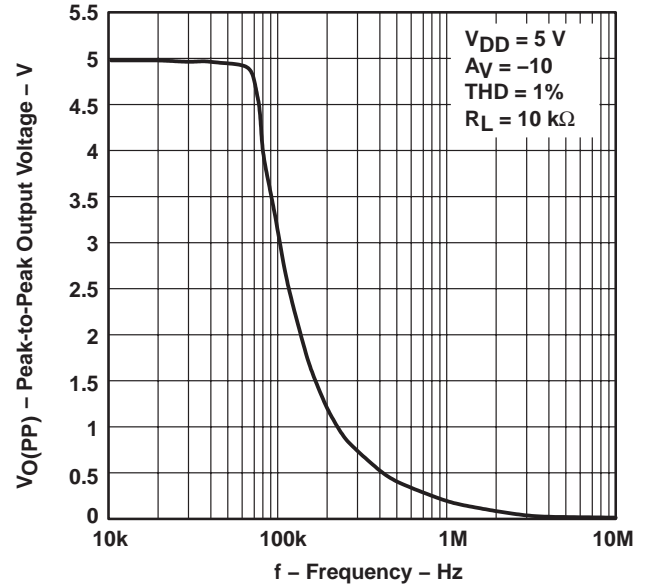

Figure 10

OPEN-LOOP GAIN AND PHASE
 VS
 FREQUENCY

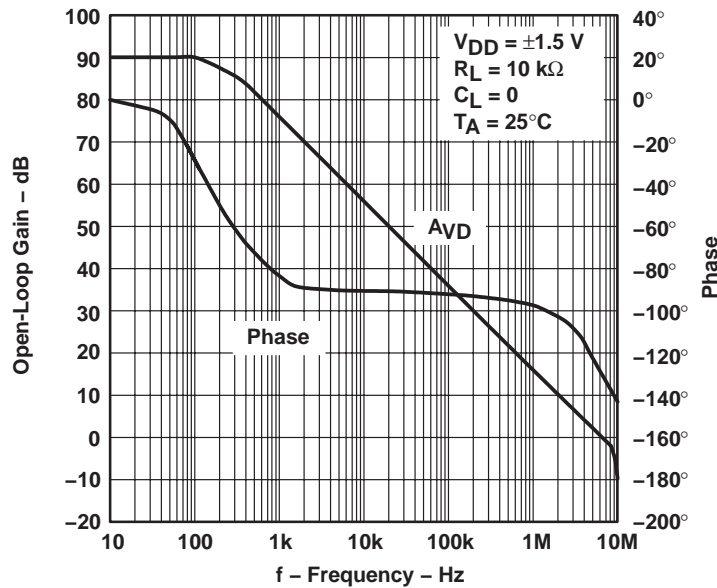

Figure 11

TLV2460A-Q1, TLV2461A-Q1, TLV2462A-Q1, TLV2463A-Q1, TLV2464A-Q1
FAMILY OF LOW-POWER RAIL-TO-RAIL INPUT/OUTPUT
OPERATIONAL AMPLIFIERS WITH SHUTDOWN

SGLS008B – MARCH 2003 – REVISED MAY 2004

TYPICAL CHARACTERISTICS

OPEN-LOOP GAIN AND PHASE
vs
FREQUENCY

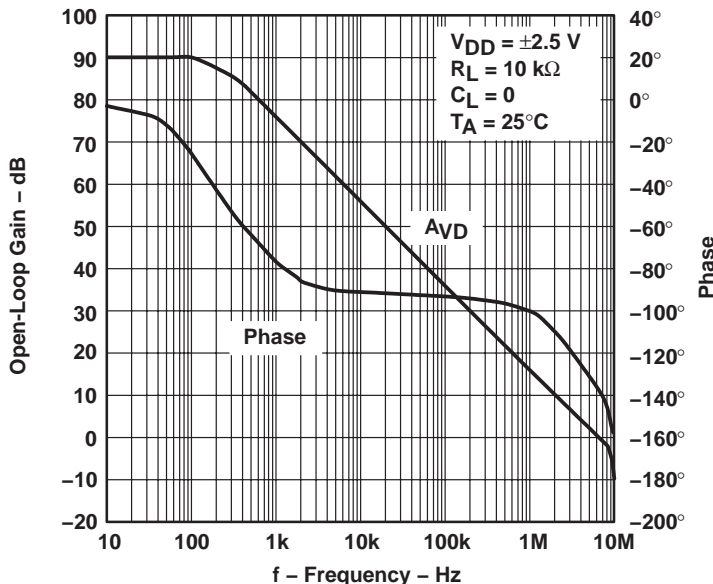

Figure 12

DIFFERENTIAL VOLTAGE AMPLIFICATION
vs
LOAD RESISTANCE

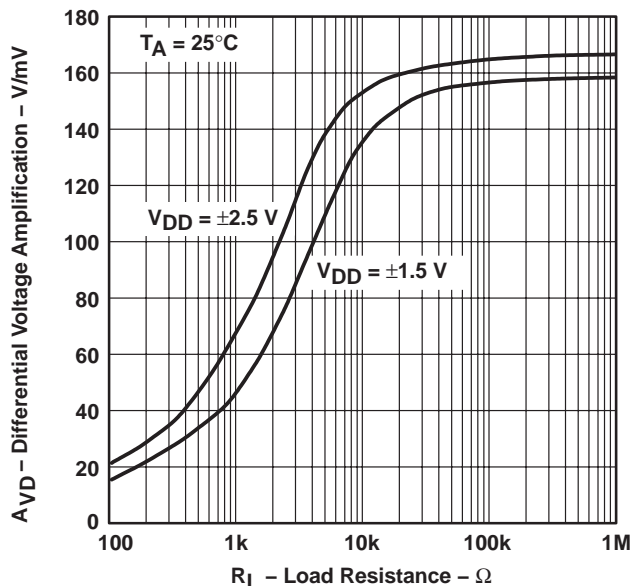

Figure 13

CAPACITIVE LOAD
vs
LOAD RESISTANCE

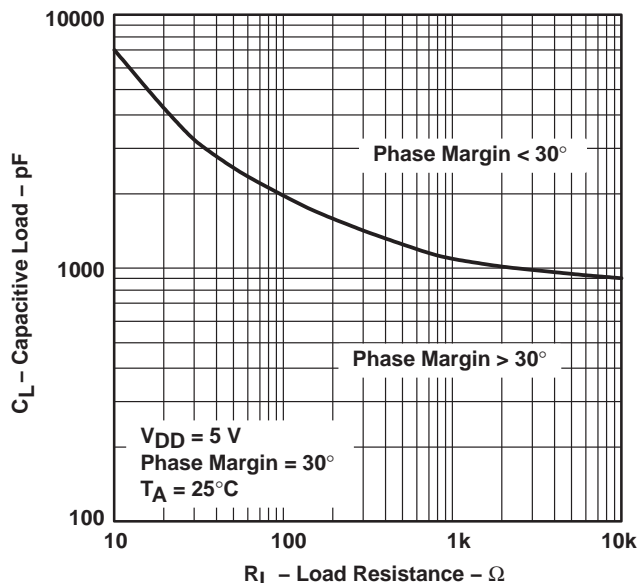

Figure 14



TLV2460A-Q1, TLV2461A-Q1, TLV2462A-Q1, TLV2463A-Q1, TLV2464A-Q1
 FAMILY OF LOW-POWER RAIL-TO-RAIL INPUT/OUTPUT
 OPERATIONAL AMPLIFIERS WITH SHUTDOWN

SGLS008B – MARCH 2003 – REVISED MAY 2004

TYPICAL CHARACTERISTICS

OUTPUT IMPEDANCE
 vs
 FREQUENCY

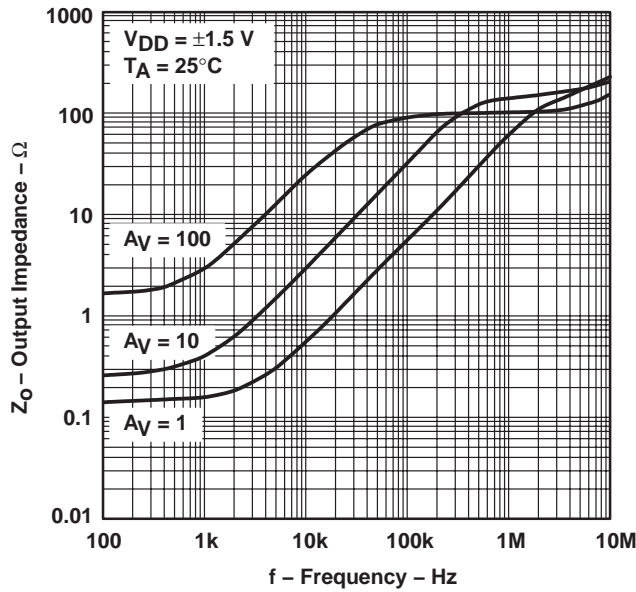

Figure 15

OUTPUT IMPEDANCE
 vs
 FREQUENCY

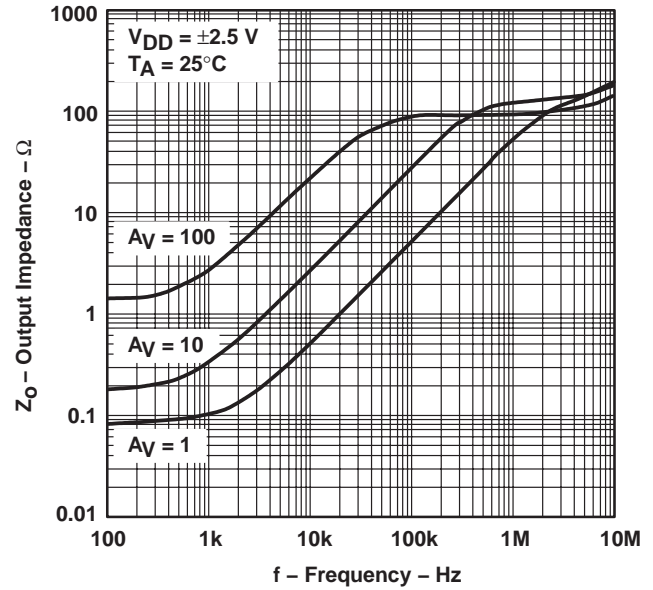

Figure 16

COMMON-MODE REJECTION RATIO
 vs
 FREQUENCY

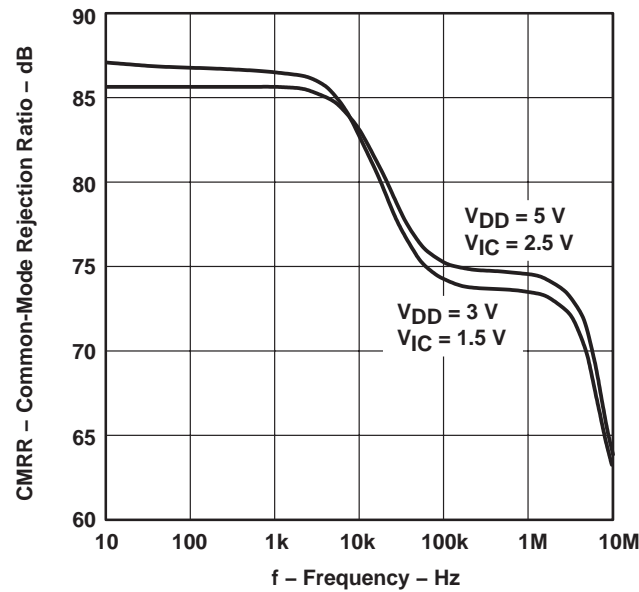

Figure 17

TLV2460A-Q1, TLV2461A-Q1, TLV2462A-Q1, TLV2463A-Q1, TLV2464A-Q1
FAMILY OF LOW-POWER RAIL-TO-RAIL INPUT/OUTPUT
OPERATIONAL AMPLIFIERS WITH SHUTDOWN

SGLS008B – MARCH 2003 – REVISED MAY 2004

TYPICAL CHARACTERISTICS

SUPPLY-VOLTAGE REJECTION RATIO
vs
FREQUENCY

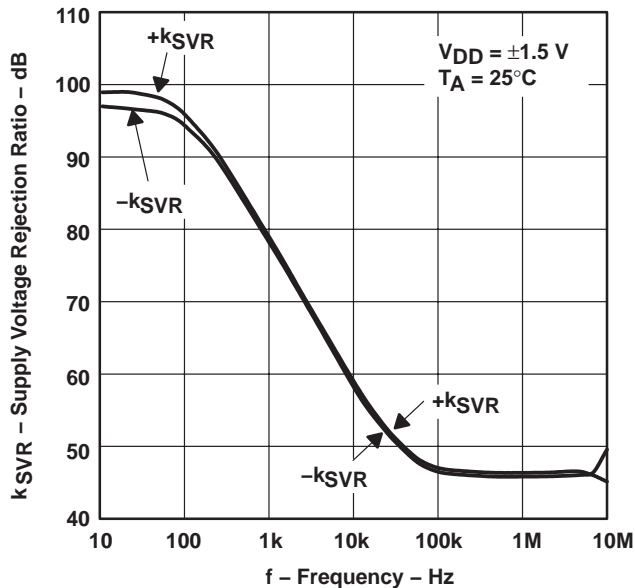

Figure 18

SUPPLY-VOLTAGE REJECTION RATIO
vs
FREQUENCY

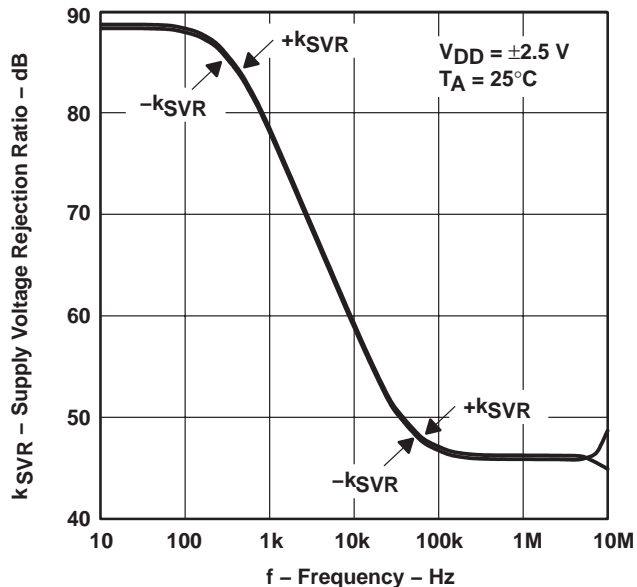

Figure 19

SUPPLY CURRENT
vs
SUPPLY VOLTAGE

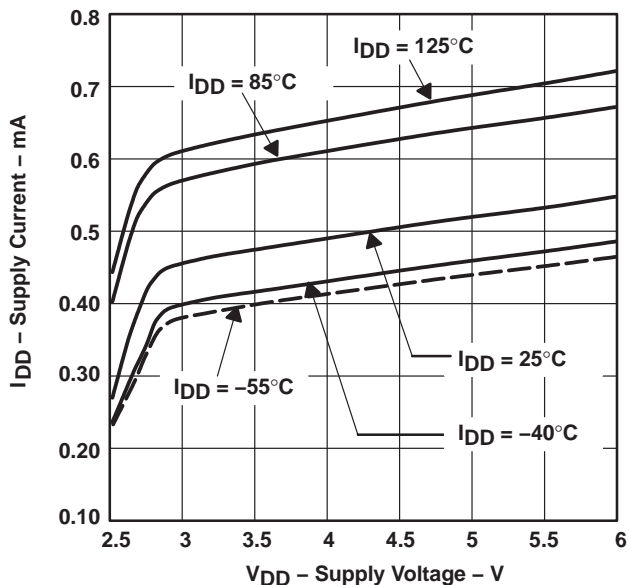

Figure 20

SUPPLY CURRENT
vs
FREE-AIR TEMPERATURE

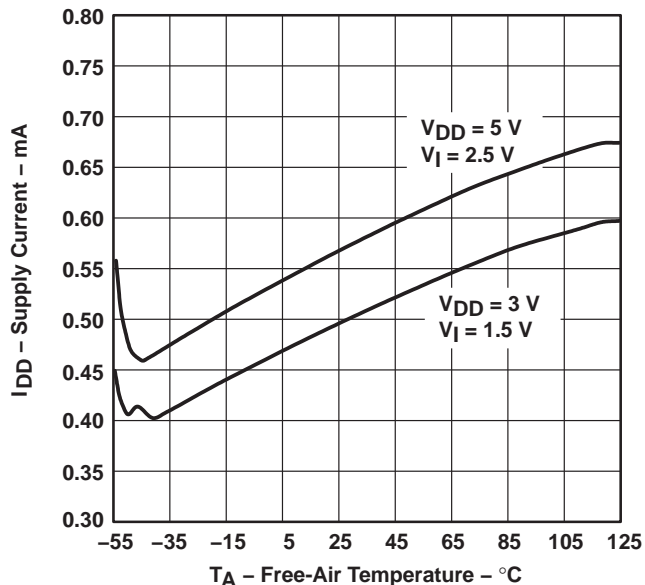

Figure 21



TLV2460A-Q1, TLV2461A-Q1, TLV2462A-Q1, TLV2463A-Q1, TLV2464A-Q1
 FAMILY OF LOW-POWER RAIL-TO-RAIL INPUT/OUTPUT
 OPERATIONAL AMPLIFIERS WITH SHUTDOWN

SGLS008B – MARCH 2003 – REVISED MAY 2004

TYPICAL CHARACTERISTICS

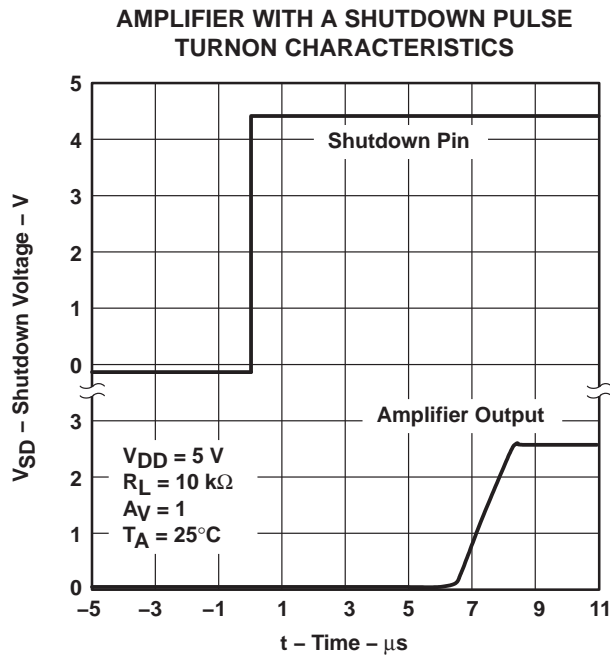

Figure 22

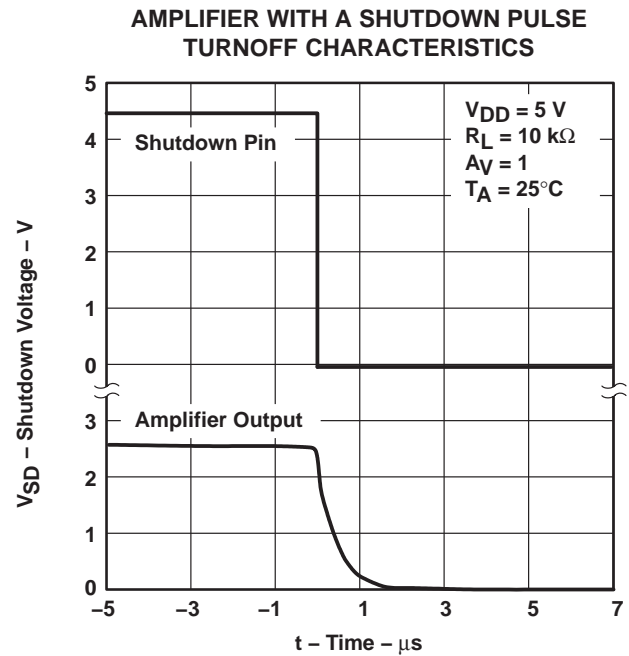

Figure 23

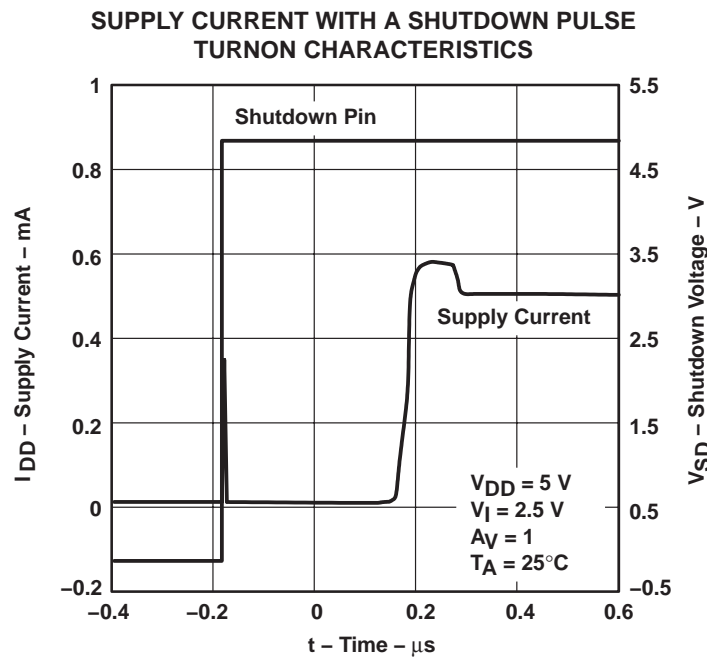

Figure 24

TLV2460A-Q1, TLV2461A-Q1, TLV2462A-Q1, TLV2463A-Q1, TLV2464A-Q1
FAMILY OF LOW-POWER RAIL-TO-RAIL INPUT/OUTPUT
OPERATIONAL AMPLIFIERS WITH SHUTDOWN

SGLS008B – MARCH 2003 – REVISED MAY 2004

TYPICAL CHARACTERISTICS

TURNOFF SUPPLY CURRENT WITH A SHUTDOWN PULSE

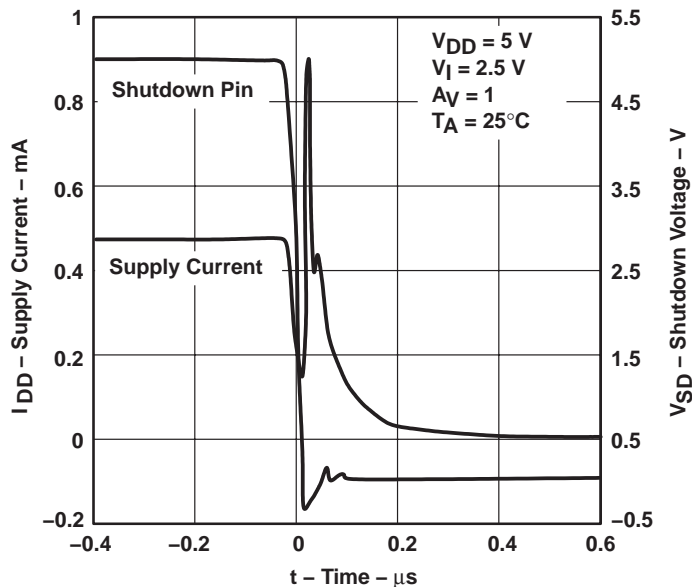

Figure 25

SHUTDOWN SUPPLY CURRENT vs FREE-AIR TEMPERATURE

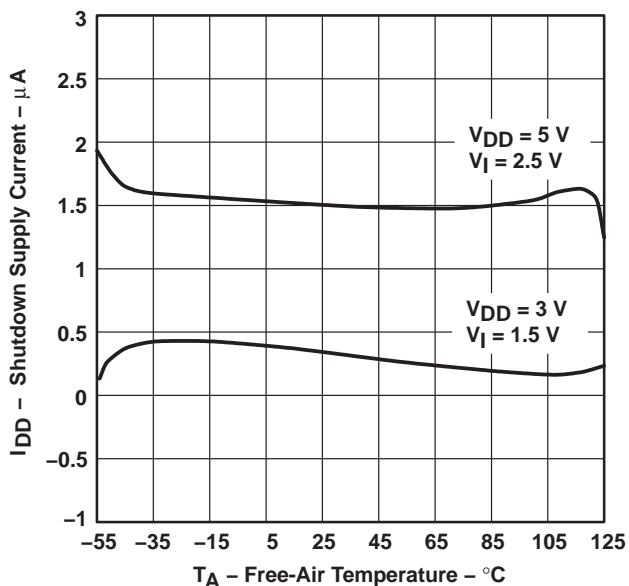

Figure 26

SLEW RATE vs SUPPLY VOLTAGE

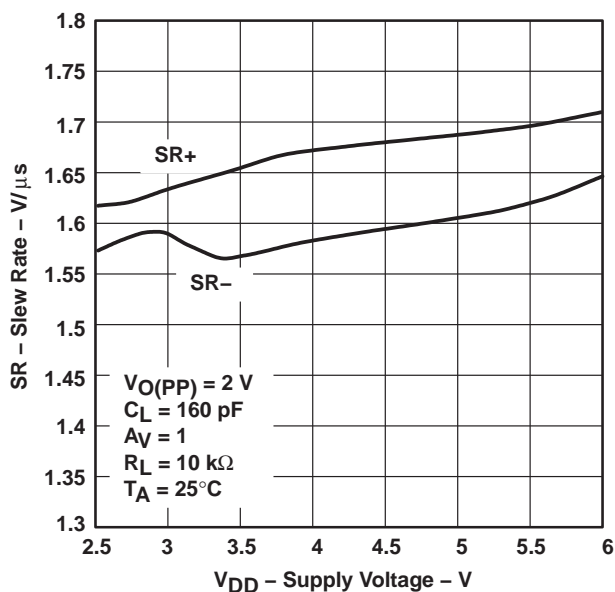

Figure 27



TLV2460A-Q1, TLV2461A-Q1, TLV2462A-Q1, TLV2463A-Q1, TLV2464A-Q1
 FAMILY OF LOW-POWER RAIL-TO-RAIL INPUT/OUTPUT
 OPERATIONAL AMPLIFIERS WITH SHUTDOWN

SGLS008B – MARCH 2003 – REVISED MAY 2004

TYPICAL CHARACTERISTICS

EQUIVALENT INPUT NOISE VOLTAGE
 vs
 FREQUENCY

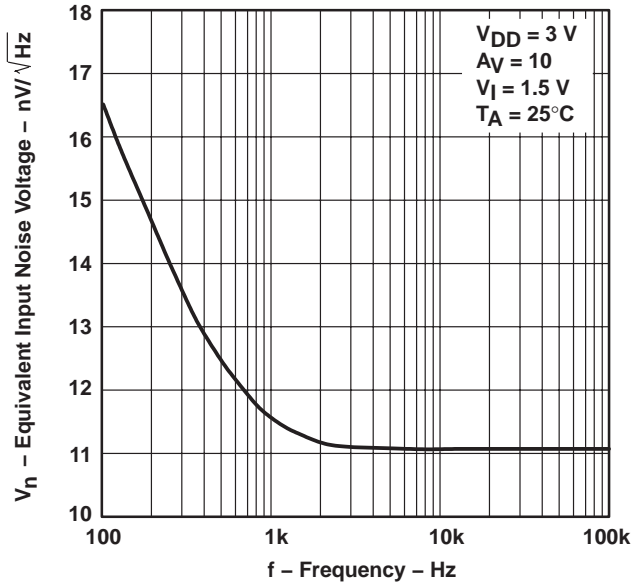

Figure 28

EQUIVALENT INPUT NOISE VOLTAGE
 vs
 FREQUENCY

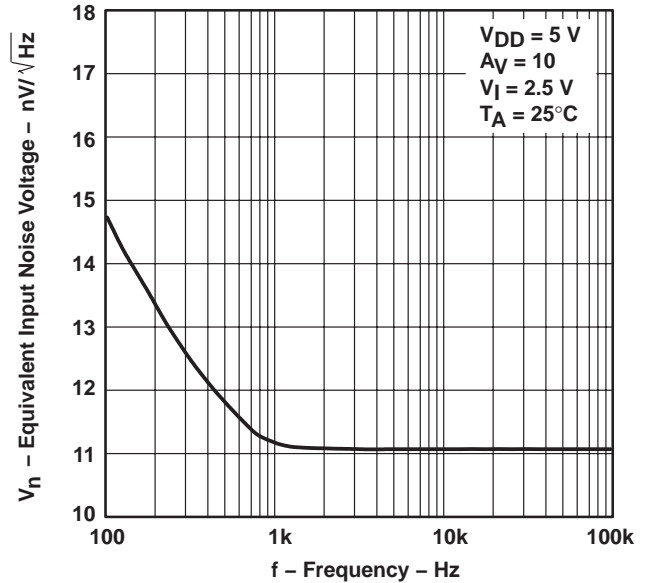

Figure 29

EQUIVALENT INPUT NOISE VOLTAGE
 vs
 COMMON-MODE INPUT VOLTAGE

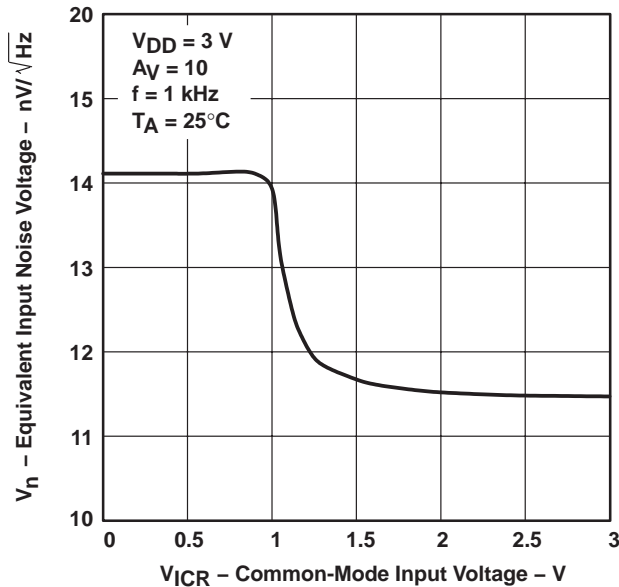

Figure 30

EQUIVALENT INPUT NOISE VOLTAGE
 vs
 COMMON-MODE INPUT VOLTAGE

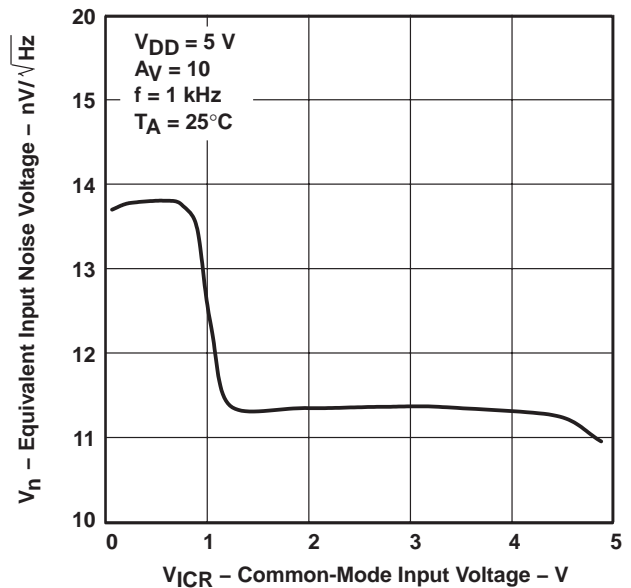

Figure 31

TLV2460A-Q1, TLV2461A-Q1, TLV2462A-Q1, TLV2463A-Q1, TLV2464A-Q1
FAMILY OF LOW-POWER RAIL-TO-RAIL INPUT/OUTPUT
OPERATIONAL AMPLIFIERS WITH SHUTDOWN

SGLS008B – MARCH 2003 – REVISED MAY 2004

TYPICAL CHARACTERISTICS

TOTAL HARMONIC DISTORTION
VS
FREQUENCY

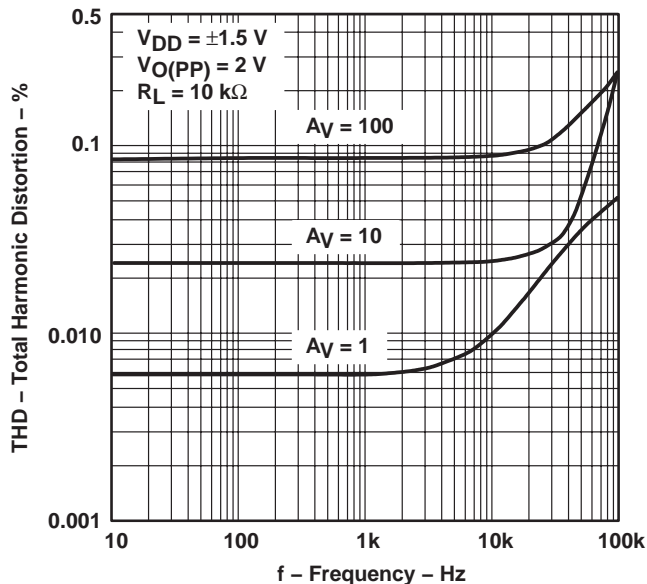

Figure 32

TOTAL HARMONIC DISTORTION
VS
FREQUENCY

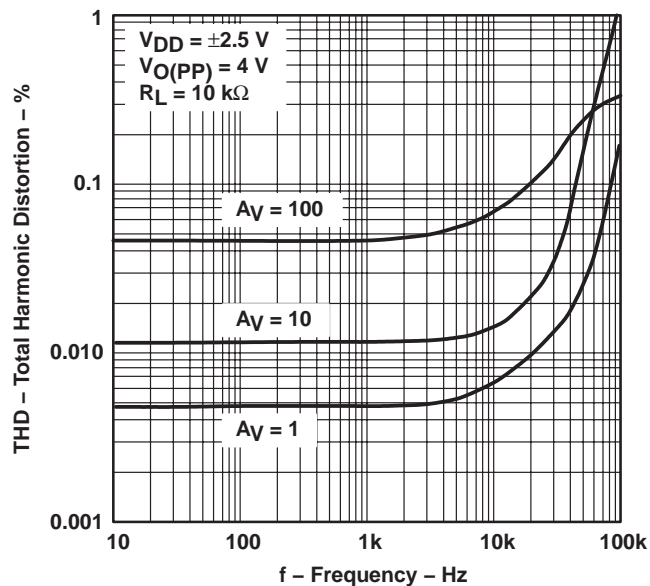

Figure 33

TOTAL HARMONIC DISTORTION PLUS NOISE
VS
PEAK-TO-PEAK SIGNAL AMPLITUDE

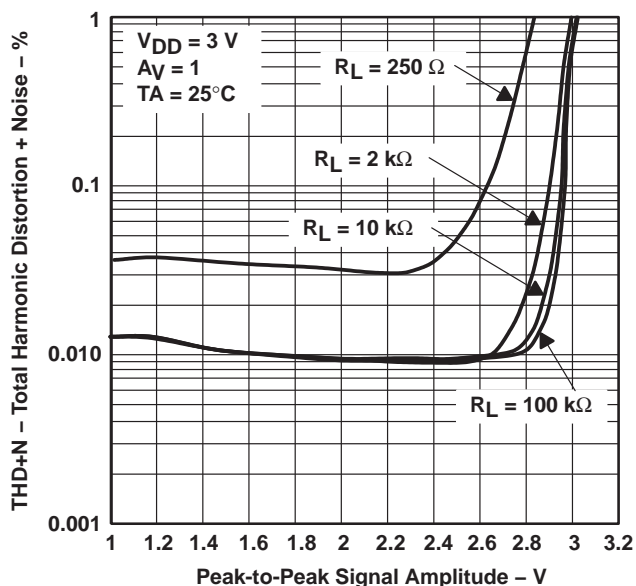

Figure 34

TOTAL HARMONIC DISTORTION PLUS NOISE
VS
PEAK-TO-PEAK SIGNAL AMPLITUDE

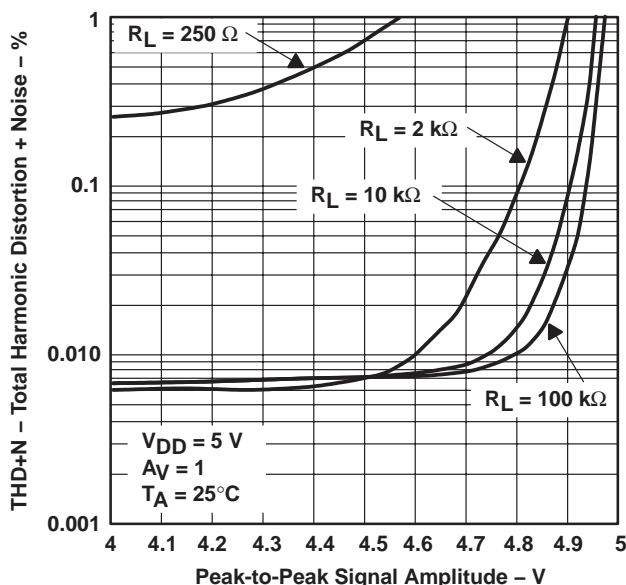

Figure 35



TLV2460A-Q1, TLV2461A-Q1, TLV2462A-Q1, TLV2463A-Q1, TLV2464A-Q1
 FAMILY OF LOW-POWER RAIL-TO-RAIL INPUT/OUTPUT
 OPERATIONAL AMPLIFIERS WITH SHUTDOWN

SGLS008B – MARCH 2003 – REVISED MAY 2004

TYPICAL CHARACTERISTICS

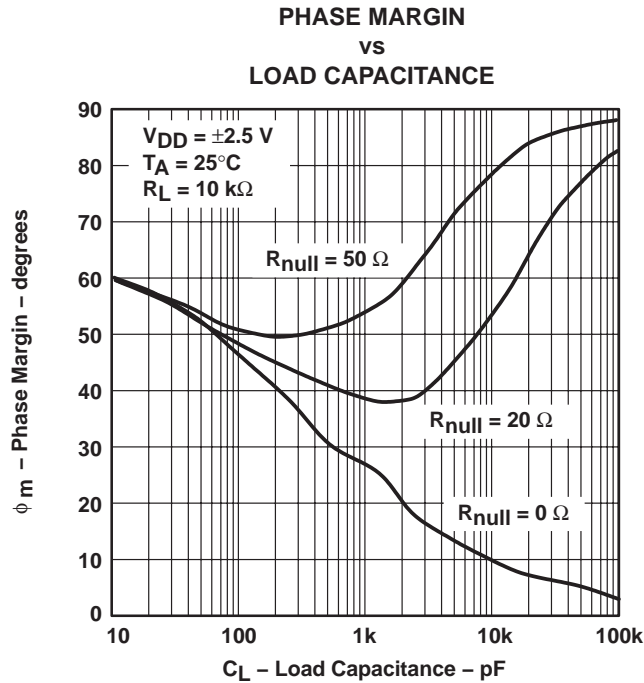

Figure 36

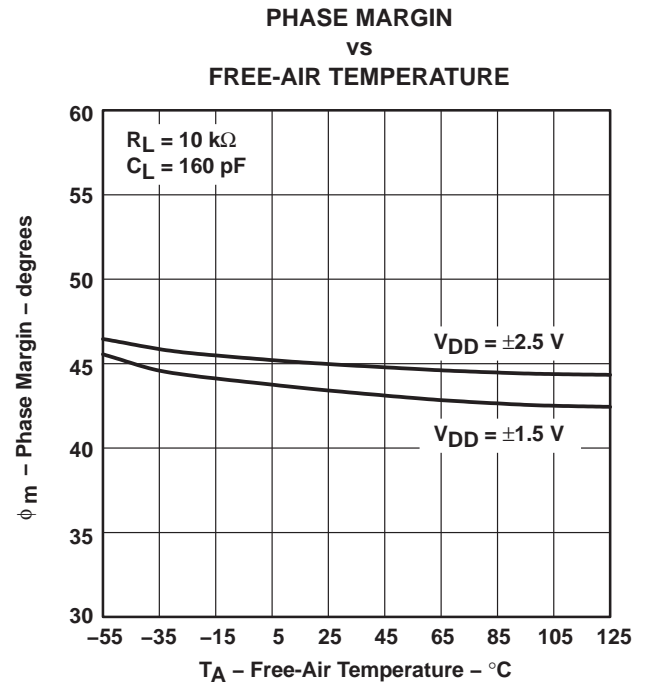

Figure 37

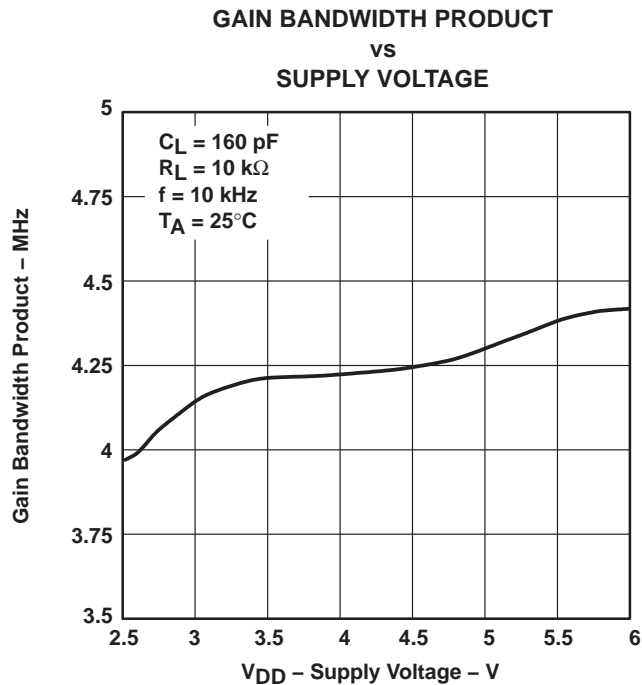

Figure 38

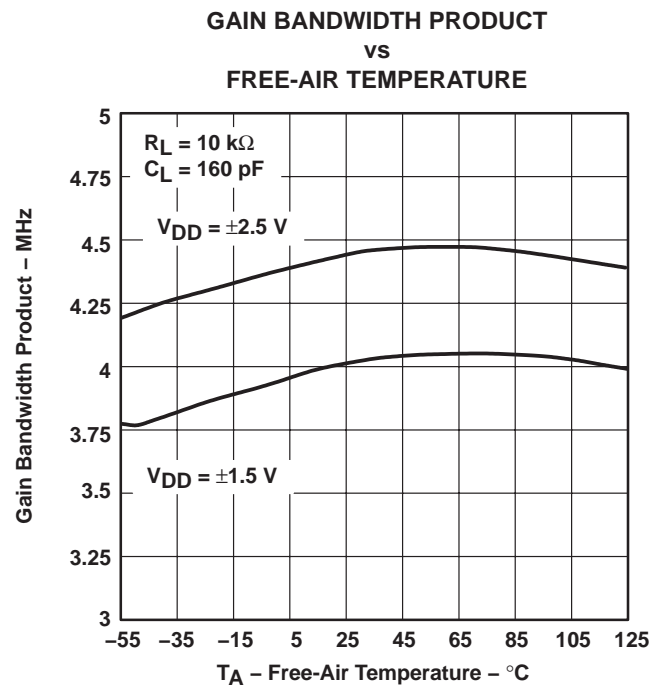

Figure 39



TLV2460A-Q1, TLV2461A-Q1, TLV2462A-Q1, TLV2463A-Q1, TLV2464A-Q1
FAMILY OF LOW-POWER RAIL-TO-RAIL INPUT/OUTPUT
OPERATIONAL AMPLIFIERS WITH SHUTDOWN

SGLS008B – MARCH 2003 – REVISED MAY 2004

TYPICAL CHARACTERISTICS

LARGE SIGNAL FOLLOWER

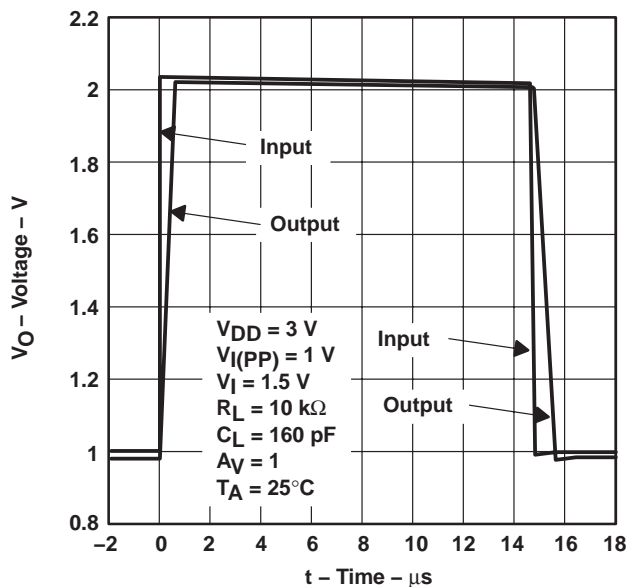

Figure 40

LARGE SIGNAL FOLLOWER

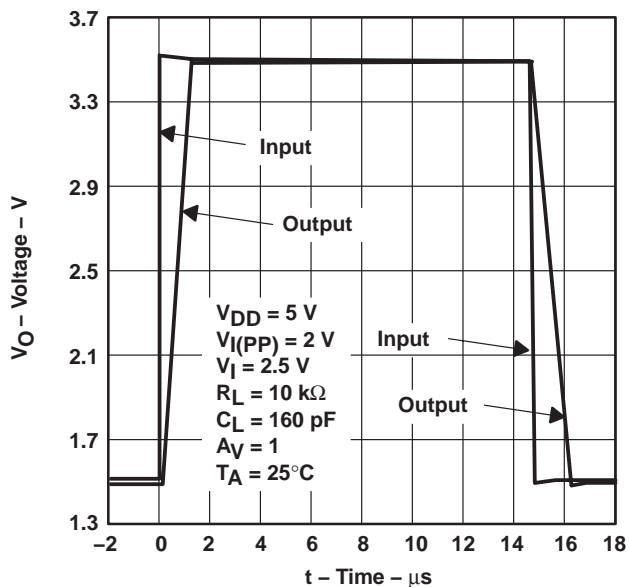

Figure 41

SMALL SIGNAL FOLLOWER

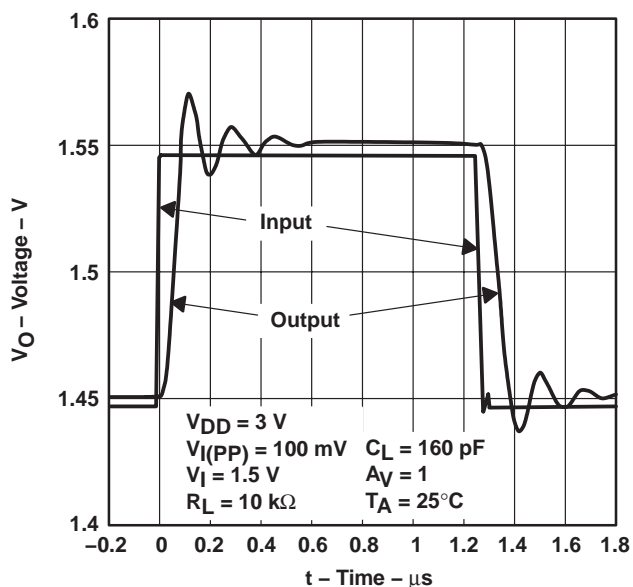

Figure 42

SMALL SIGNAL FOLLOWER

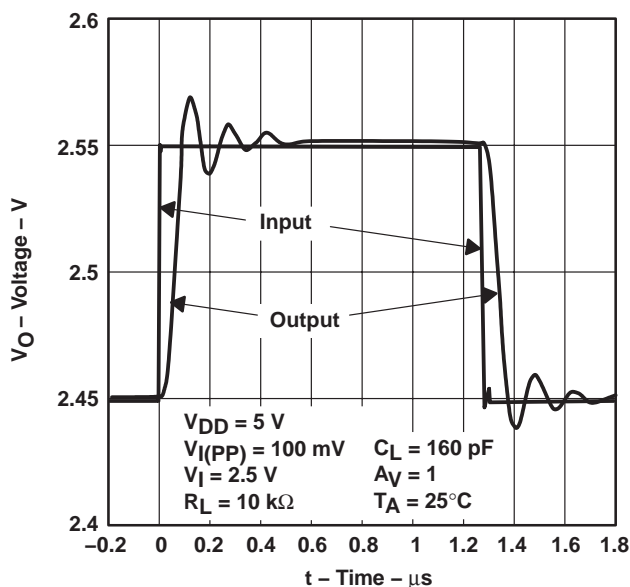

Figure 43



TLV2460A-Q1, TLV2461A-Q1, TLV2462A-Q1, TLV2463A-Q1, TLV2464A-Q1
 FAMILY OF LOW-POWER RAIL-TO-RAIL INPUT/OUTPUT
 OPERATIONAL AMPLIFIERS WITH SHUTDOWN

SGLS008B – MARCH 2003 – REVISED MAY 2004

TYPICAL CHARACTERISTICS

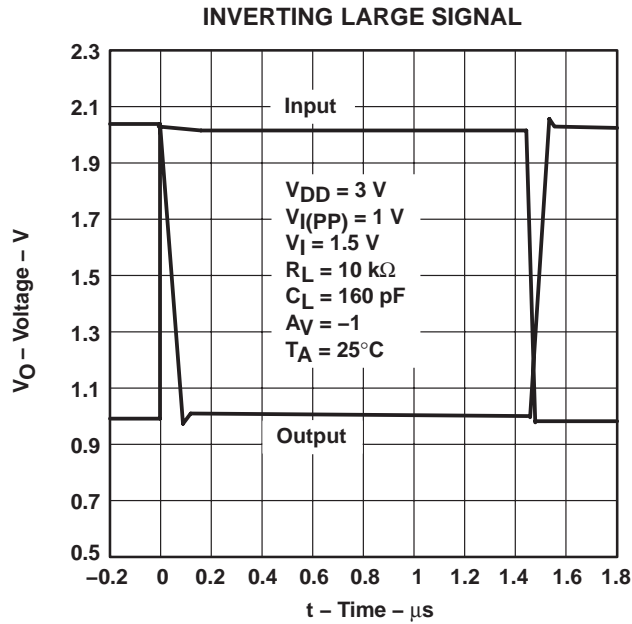

Figure 44

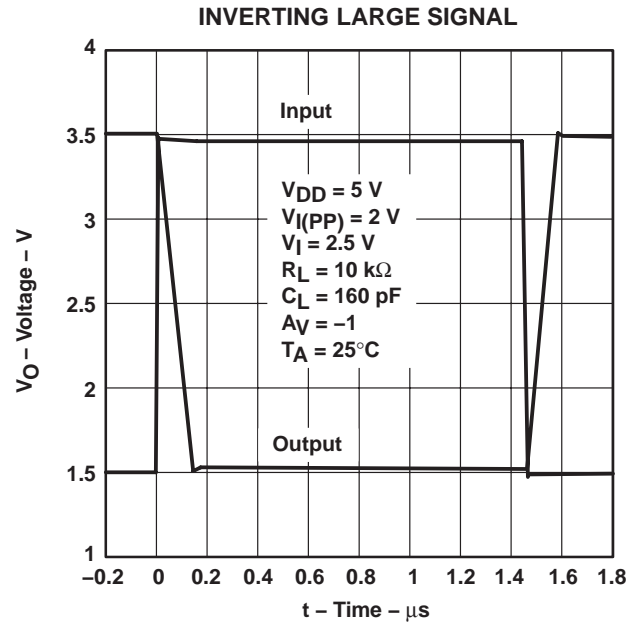

Figure 45

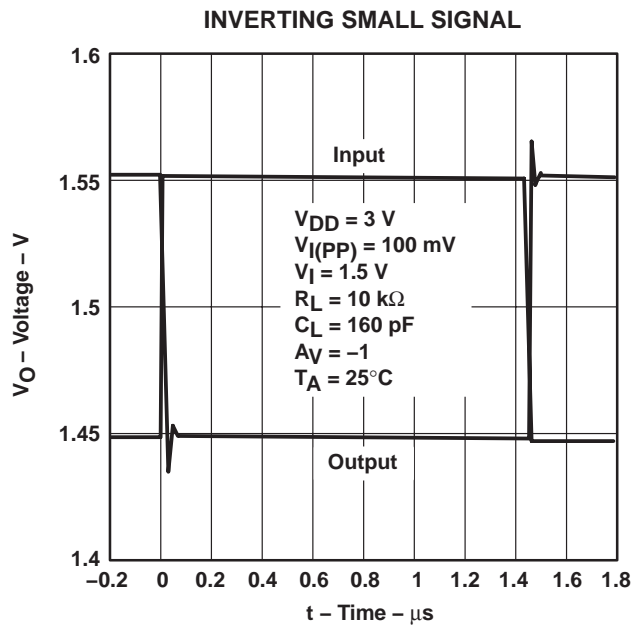

Figure 46

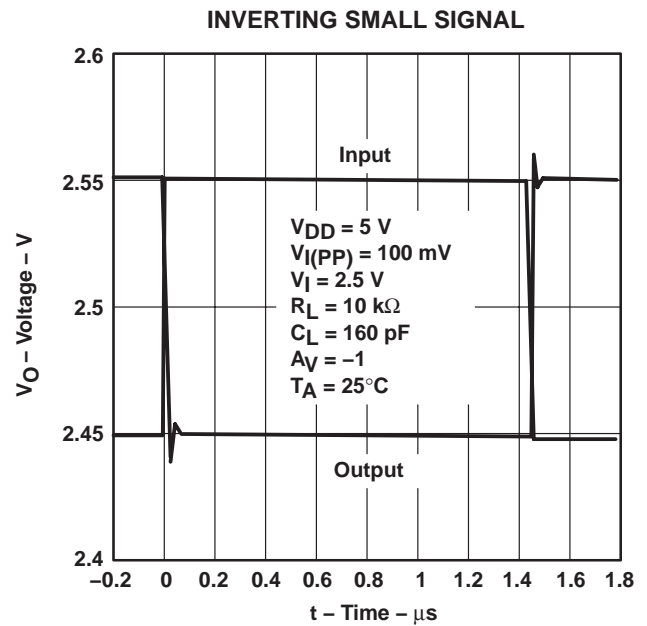

Figure 47

TLV2460A-Q1, TLV2461A-Q1, TLV2462A-Q1, TLV2463A-Q1, TLV2464A-Q1
FAMILY OF LOW-POWER RAIL-TO-RAIL INPUT/OUTPUT
OPERATIONAL AMPLIFIERS WITH SHUTDOWN

SGLS008B – MARCH 2003 – REVISED MAY 2004

PARAMETER MEASUREMENT INFORMATION

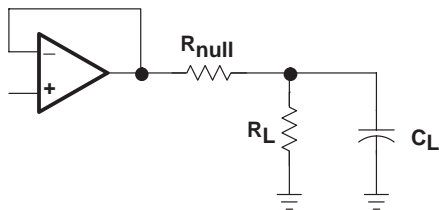

Figure 48

APPLICATION INFORMATION

driving a capacitive load

When the amplifier is configured in this manner, capacitive loading directly on the output will decrease the device's phase margin leading to high frequency ringing or oscillations. Therefore, for capacitive loads of greater than 10 pF, it is recommended that a resistor be placed in series (R_{NULL}) with the output of the amplifier, as shown in Figure 49. A minimum value of 20 Ω should work well for most applications.

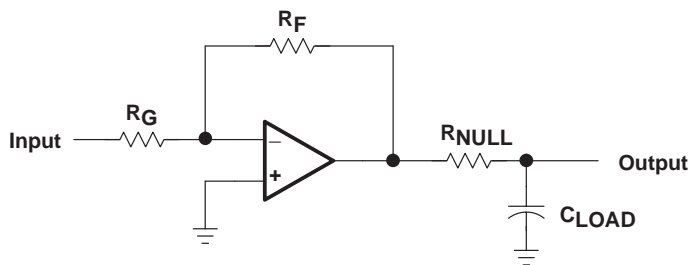

Figure 49. Driving a Capacitive Load

offset voltage

The output offset voltage, (V_{OO}) is the sum of the input offset voltage (V_{IO}) and both input bias currents (I_{IB}) times the corresponding gains. The following schematic and formula can be used to calculate the output offset voltage:

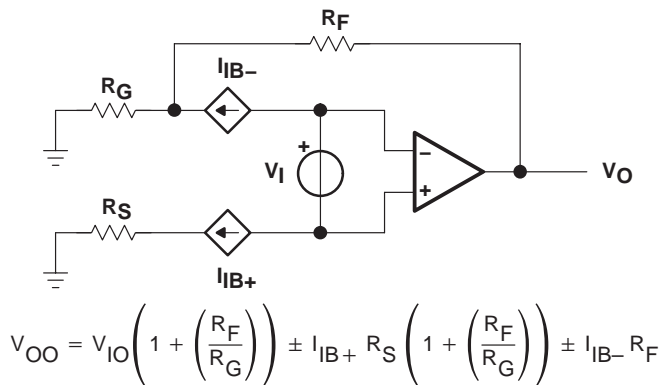

Figure 50. Output Offset Voltage Model

APPLICATION INFORMATION

general configurations

When receiving low-level signals, limiting the bandwidth of the incoming signals into the system is often required. The simplest way to accomplish this is to place an RC filter at the noninverting terminal of the amplifier (see Figure 51).

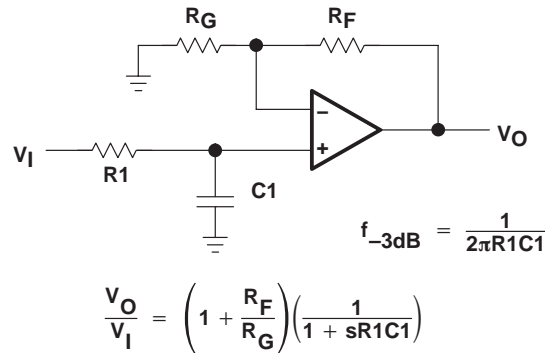

Figure 51. Single-Pole Low-Pass Filter

If even more attenuation is needed, a multiple pole filter is required. The Sallen-Key filter can be used for this task. For best results, the amplifier should have a bandwidth that is 8 to 10 times the filter frequency bandwidth. Failure to do this can result in phase shift of the amplifier.

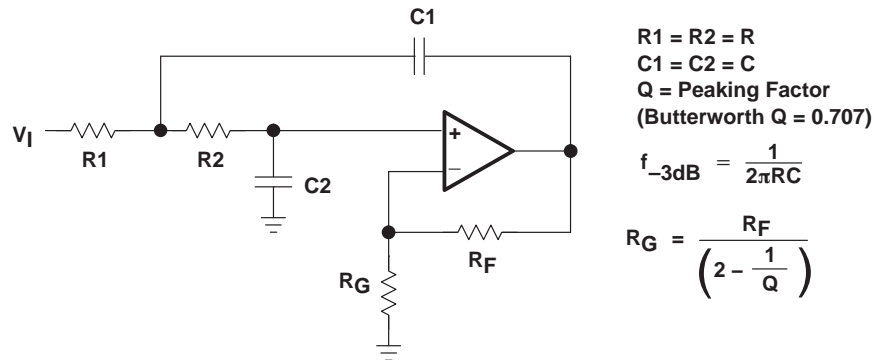

Figure 52. 2-Pole Low-Pass Sallen-Key Filter

TLV2460A-Q1, TLV2461A-Q1, TLV2462A-Q1, TLV2463A-Q1, TLV2464A-Q1

FAMILY OF LOW-POWER RAIL-TO-RAIL INPUT/OUTPUT OPERATIONAL AMPLIFIERS WITH SHUTDOWN

SGLS008B – MARCH 2003 – REVISED MAY 2004

APPLICATION INFORMATION

shutdown function

Three members of the TLV246x family (TLV2460/3/5) have a shutdown terminal for conserving battery life in portable applications. When the shutdown terminal is tied low, the supply current is reduced to 0.3 μA /channel, the amplifier is disabled, and the outputs are placed in a high impedance mode. To enable the amplifier, the shutdown terminal can either be left floating or pulled high. When the shutdown terminal is left floating, care should be taken to ensure that parasitic leakage current at the shutdown terminal does not inadvertently place the operational amplifier into shutdown. The shutdown terminal threshold is always referenced to $V_{DD}/2$. Therefore, when operating the device with split supply voltages (e.g. $\pm 2.5\text{ V}$), the shutdown terminal needs to be pulled to V_{DD-} (not GND) to disable the operational amplifier.

The amplifier's output with a shutdown pulse is shown in Figures 22, 23, 24, and 25. The amplifier is powered with a single 5-V supply and configured as a noninverting configuration with a gain of 5. The amplifier turnon and turnoff times are measured from the 50% point of the shutdown pulse to the 50% point of the output waveform. The times for the single, dual, and quad are listed in the data tables.

circuit layout considerations

To achieve the levels of high performance of the TLV246x, follow proper printed-circuit board design techniques. A general set of guidelines is given in the following.

- Ground planes – It is highly recommended that a ground plane be used on the board to provide all components with a low inductive ground connection. However, in the areas of the amplifier inputs and output, the ground plane can be removed to minimize the stray capacitance.
- Proper power supply decoupling – Use a 6.8- μF tantalum capacitor in parallel with a 0.1- μF ceramic capacitor on each supply terminal. It may be possible to share the tantalum among several amplifiers depending on the application, but a 0.1- μF ceramic capacitor should always be used on the supply terminal of every amplifier. In addition, the 0.1- μF capacitor should be placed as close as possible to the supply terminal. As this distance increases, the inductance in the connecting trace makes the capacitor less effective. The designer should strive for distances of less than 0.1 inches between the device power terminals and the ceramic capacitors.
- Sockets – Sockets can be used but are not recommended. The additional lead inductance in the socket pins will often lead to stability problems. Surface-mount packages soldered directly to the printed-circuit board is the best implementation.
- Short trace runs/compact part placements – Optimum high performance is achieved when stray series inductance has been minimized. To realize this, the circuit layout should be made as compact as possible, thereby minimizing the length of all trace runs. Particular attention should be paid to the inverting input of the amplifier. Its length should be kept as short as possible. This will help to minimize stray capacitance at the input of the amplifier.
- Surface-mount passive components – Using surface-mount passive components is recommended for high performance amplifier circuits for several reasons. First, because of the extremely low lead inductance of surface-mount components, the problem with stray series inductance is greatly reduced. Second, the small size of surface-mount components naturally leads to a more compact layout thereby minimizing both stray inductance and capacitance. If leaded components are used, it is recommended that the lead lengths be kept as short as possible.

APPLICATION INFORMATION

general power dissipation considerations

For a given θ_{JA} , the maximum power dissipation is shown in Figure 53 and is calculated by the following formula:

$$P_D = \left(\frac{T_{MAX} - T_A}{\theta_{JA}} \right)$$

Where:

- P_D = Maximum power dissipation of THS246x IC (watts)
- T_{MAX} = Absolute maximum junction temperature (150°C)
- T_A = Free-ambient air temperature (°C)
- $\theta_{JA} = \theta_{JC} + \theta_{CA}$
- θ_{JC} = Thermal coefficient from junction to case
- θ_{CA} = Thermal coefficient from case to ambient air (°C/W)

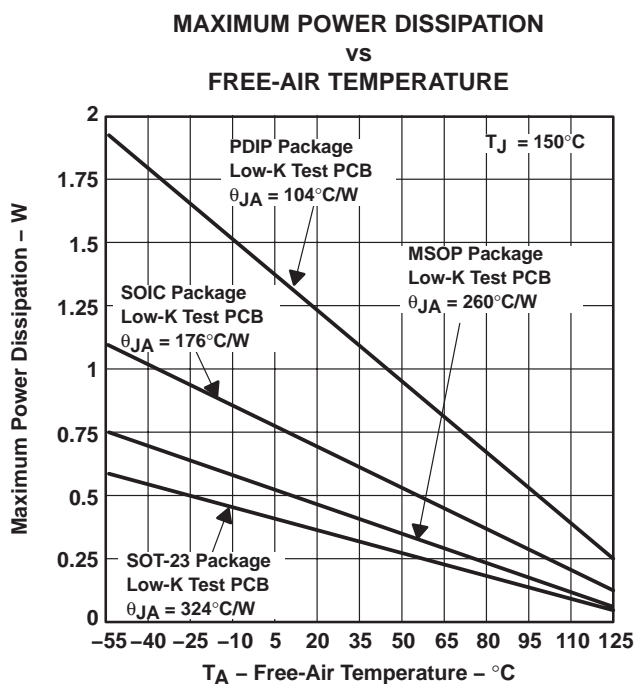

NOTE A: Results are with no air flow and using JEDEC Standard Low-K test PCB.

Figure 53. Maximum Power Dissipation vs Free-Air Temperature

TLV2460A-Q1, TLV2461A-Q1, TLV2462A-Q1, TLV2463A-Q1, TLV2464A-Q1 FAMILY OF LOW-POWER RAIL-TO-RAIL INPUT/OUTPUT OPERATIONAL AMPLIFIERS WITH SHUTDOWN

SGLS008B – MARCH 2003 – REVISED MAY 2004

APPLICATION INFORMATION

macromodel information

Macromodel information provided was derived using Microsim *Parts*™ Release 8, the model generation software used with Microsim *PSpice*™. The Boyle macromodel (see Note 2) and subcircuit in Figure 54 are generated using the TLV246x typical electrical and operating characteristics at $T_A = 25^\circ\text{C}$. Using this information, output simulations of the following key parameters can be generated to a tolerance of 20% (in most cases):

- Maximum positive output voltage swing
- Maximum negative output voltage swing
- Slew rate
- Quiescent power dissipation
- Input bias current
- Open-loop voltage amplification
- Unity-gain frequency
- Common-mode rejection ratio
- Phase margin
- DC output resistance
- AC output resistance
- Short-circuit output current limit

NOTE 2: G. R. Boyle, B. M. Cohn, D. O. Pederson, and J. E. Solomon, "Macromodeling of Intergrated Circuit Operational Amplifiers", *IEEE Journal of Solid-State Circuits*, SC-9, 353 (1974).

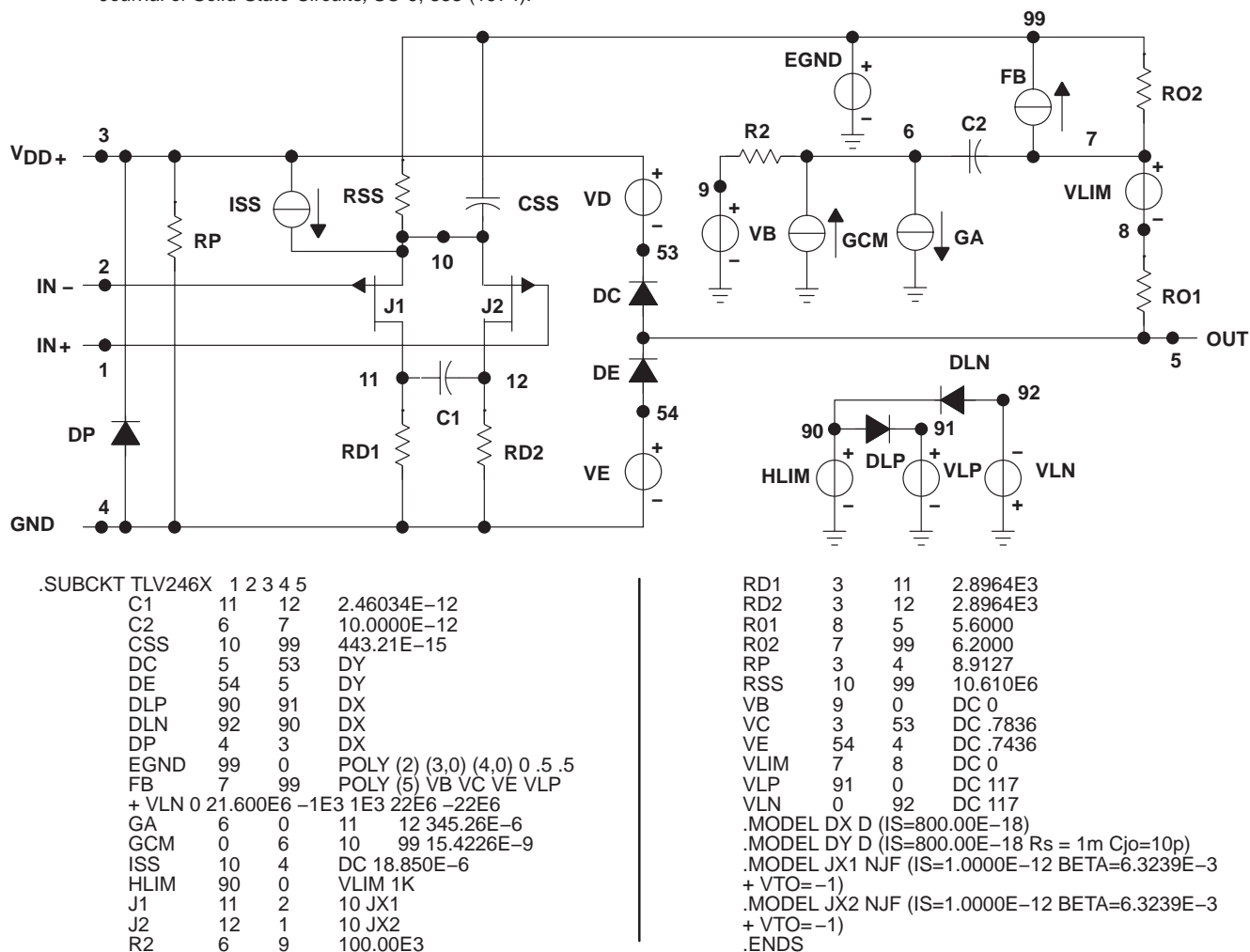

Figure 54. Boyle Macromodels and Subcircuit

PSpice and *Parts* are trademarks of MicroSim Corporation.



TLV2460A-Q1, TLV2461A-Q1, TLV2462A-Q1, TLV2463A-Q1, TLV2464A-Q1
FAMILY OF LOW-POWER RAIL-TO-RAIL INPUT/OUTPUT
OPERATIONAL AMPLIFIERS WITH SHUTDOWN

SGLS008B – MARCH 2003 – REVISED MAY 2004

macromodel information (continued)

```
.subckt TLV_246Y 1 2 3 4 5 6
  c1      11 12 2.4603E-12
  c2      72 7 10.000E-12
  css     10 99 443.21E-15
  dc      70 53 dy
  de      54 70 dy
  dlp     90 91 dx
  dln     92 90 dx
  dp      4 3 dx
  egnd    99 0 poly(2) (3,0) (4,0) 0 .5 .5
  fb      7 99 poly(5) vb vc ve vlp vln 0
21.600E6 -1E3 1E3 22E6 -22E6
  ga      72 0 11 12 345.26E-6
  gcm     0 72 10 99 15.422E-9
  iss     74 4 dc 18.850E-6
  hlim    90 0 vlim 1K
  j1      11 2 10 jx1
  j2      12 1 10 jx2
  r2      72 9 100.00E3
  rd1     3 11 2.8964E3
  rd2     3 12 2.8964E3
  ro1     8 70 5.6000
  ro2     7 99 6.2000

  rp      3 71 8.9127
  rss     10 99 10.610E6
  rs1     6 4 1G
  rs2     6 4 1G
  rs3     6 4 1G
  rs4     6 4 1G
  s1      71 4 6 4 s1x
  s2      70 5 6 4 s1x
  s3      10 74 6 4 s1x
  s4      74 4 6 4 s2x
  vb      9 0 dc 0
  vc      3 53 dc .7836
  ve      54 4 dc .7436
  vlim    7 8 dc 0
  vlp     91 0 dc 117
  vln     0 92 dc 117
.model dx D(Is=800.00E-18)
.model dy D(Is=800.00E-18 Rs=1m Cjo=10p)
.model jx1 NJF(Is=1.0000E-12 Beta=6.3239E-3 Vto=-1)
.model jx2 NJF(Is=1.0000E-12 Beta=6.3239E-3 Vto=-1)
.model s1x VSWITCH(Roff=1E8 Ron=1.0 Voff=2.5 Von=0.0)
.model s2x VSWITCH(Roff=1E8 Ron=1.0 Voff=0 Von=2.5)
.ends
```

Figure 54. Boyle Macromodels and Subcircuit (Continued)

PACKAGING INFORMATION

Orderable Device	Status ⁽¹⁾	Package Type	Package Drawing	Pins	Package Qty	Eco Plan ⁽²⁾	Lead/Ball Finish	MSL Peak Temp ⁽³⁾
TLV2460AQDRQ1	ACTIVE	SOIC	D	8	2500	Pb-Free (RoHS)	CU NIPDAU	Level-2-250C-1 YEAR/ Level-1-235C-UNLIM
TLV2460AQPWRQ1	ACTIVE	TSSOP	PW	8	2000	None	CU NIPDAU	Level-1-220C-UNLIM
TLV2460QDRQ1	ACTIVE	SOIC	D	8	2500	Pb-Free (RoHS)	CU NIPDAU	Level-2-250C-1 YEAR/ Level-1-235C-UNLIM
TLV2460QPWRQ1	ACTIVE	TSSOP	PW	8	2000	None	CU NIPDAU	Level-1-220C-UNLIM
TLV2461AQDRQ1	ACTIVE	SOIC	D	8	2500	Pb-Free (RoHS)	CU NIPDAU	Level-2-250C-1 YEAR/ Level-1-235C-UNLIM
TLV2461AQPWRQ1	ACTIVE	TSSOP	PW	8	2000	None	CU NIPDAU	Level-1-220C-UNLIM
TLV2461QDRQ1	ACTIVE	SOIC	D	8	2500	Pb-Free (RoHS)	CU NIPDAU	Level-2-250C-1 YEAR/ Level-1-235C-UNLIM
TLV2461QPWRQ1	ACTIVE	TSSOP	PW	8	2000	None	CU NIPDAU	Level-1-220C-UNLIM
TLV2462AQDRQ1	ACTIVE	SOIC	D	8	2500	Pb-Free (RoHS)	CU NIPDAU	Level-2-250C-1 YEAR/ Level-1-235C-UNLIM
TLV2462AQPWRQ1	ACTIVE	TSSOP	PW	8	2000	None	CU NIPDAU	Level-1-220C-UNLIM
TLV2462QDRQ1	ACTIVE	SOIC	D	8	2500	Pb-Free (RoHS)	CU NIPDAU	Level-2-250C-1 YEAR/ Level-1-235C-UNLIM
TLV2462QPWRQ1	ACTIVE	TSSOP	PW	8	2000	None	CU NIPDAU	Level-1-220C-UNLIM
TLV2463AQDRQ1	ACTIVE	SOIC	D	14	2500	Pb-Free (RoHS)	CU NIPDAU	Level-2-250C-1 YEAR/ Level-1-235C-UNLIM
TLV2463AQPWRQ1	ACTIVE	TSSOP	PW	14	2000	None	CU NIPDAU	Level-1-250C-UNLIM
TLV2463QDRQ1	ACTIVE	SOIC	D	14	2500	Pb-Free (RoHS)	CU NIPDAU	Level-2-250C-1 YEAR/ Level-1-235C-UNLIM
TLV2463QPWRQ1	ACTIVE	TSSOP	PW	14	2000	None	CU NIPDAU	Level-1-250C-UNLIM
TLV2464AQPWRQ1	ACTIVE	TSSOP	PW	14	2000	None	CU NIPDAU	Level-1-250C-UNLIM

⁽¹⁾ The marketing status values are defined as follows:

ACTIVE: Product device recommended for new designs.

LIFEBUY: TI has announced that the device will be discontinued, and a lifetime-buy period is in effect.

NRND: Not recommended for new designs. Device is in production to support existing customers, but TI does not recommend using this part in a new design.

PREVIEW: Device has been announced but is not in production. Samples may or may not be available.

OBSOLETE: TI has discontinued the production of the device.

⁽²⁾ Eco Plan - May not be currently available - please check <http://www.ti.com/productcontent> for the latest availability information and additional product content details.

None: Not yet available Lead (Pb-Free).

Pb-Free (RoHS): TI's terms "Lead-Free" or "Pb-Free" mean semiconductor products that are compatible with the current RoHS requirements for all 6 substances, including the requirement that lead not exceed 0.1% by weight in homogeneous materials. Where designed to be soldered at high temperatures, TI Pb-Free products are suitable for use in specified lead-free processes.

Green (RoHS & no Sb/Br): TI defines "Green" to mean "Pb-Free" and in addition, uses package materials that do not contain halogens, including bromine (Br) or antimony (Sb) above 0.1% of total product weight.

⁽³⁾ MSL, Peak Temp. -- The Moisture Sensitivity Level rating according to the JEDEC industry standard classifications, and peak solder temperature.

Important Information and Disclaimer: The information provided on this page represents TI's knowledge and belief as of the date that it is provided. TI bases its knowledge and belief on information provided by third parties, and makes no representation or warranty as to the accuracy of such information. Efforts are underway to better integrate information from third parties. TI has taken and continues to take reasonable steps to provide representative and accurate information but may not have conducted destructive testing or chemical analysis on incoming materials and chemicals. TI and TI suppliers consider certain information to be proprietary, and thus CAS numbers and other limited information may not be available for release.

In no event shall TI's liability arising out of such information exceed the total purchase price of the TI part(s) at issue in this document sold by TI to Customer on an annual basis.

D (R-PDSO-G14)

PLASTIC SMALL-OUTLINE PACKAGE

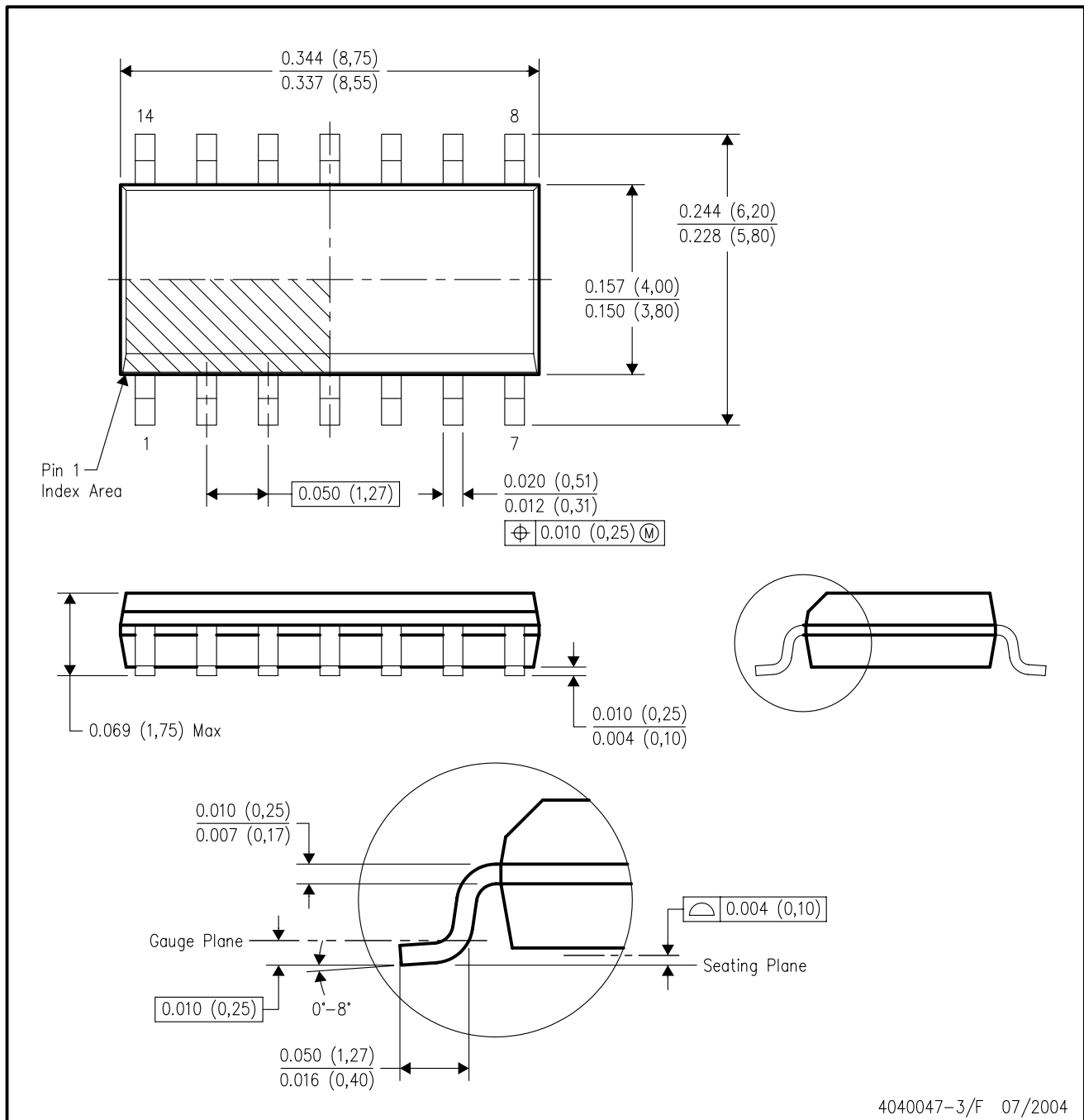

- NOTES:
- A. All linear dimensions are in inches (millimeters).
 - B. This drawing is subject to change without notice.
 - C. Body dimensions do not include mold flash or protrusion not to exceed 0.006 (0,15).
 - D. Falls within JEDEC MS-012 variation AB.

D (R-PDSO-G8)

PLASTIC SMALL-OUTLINE PACKAGE

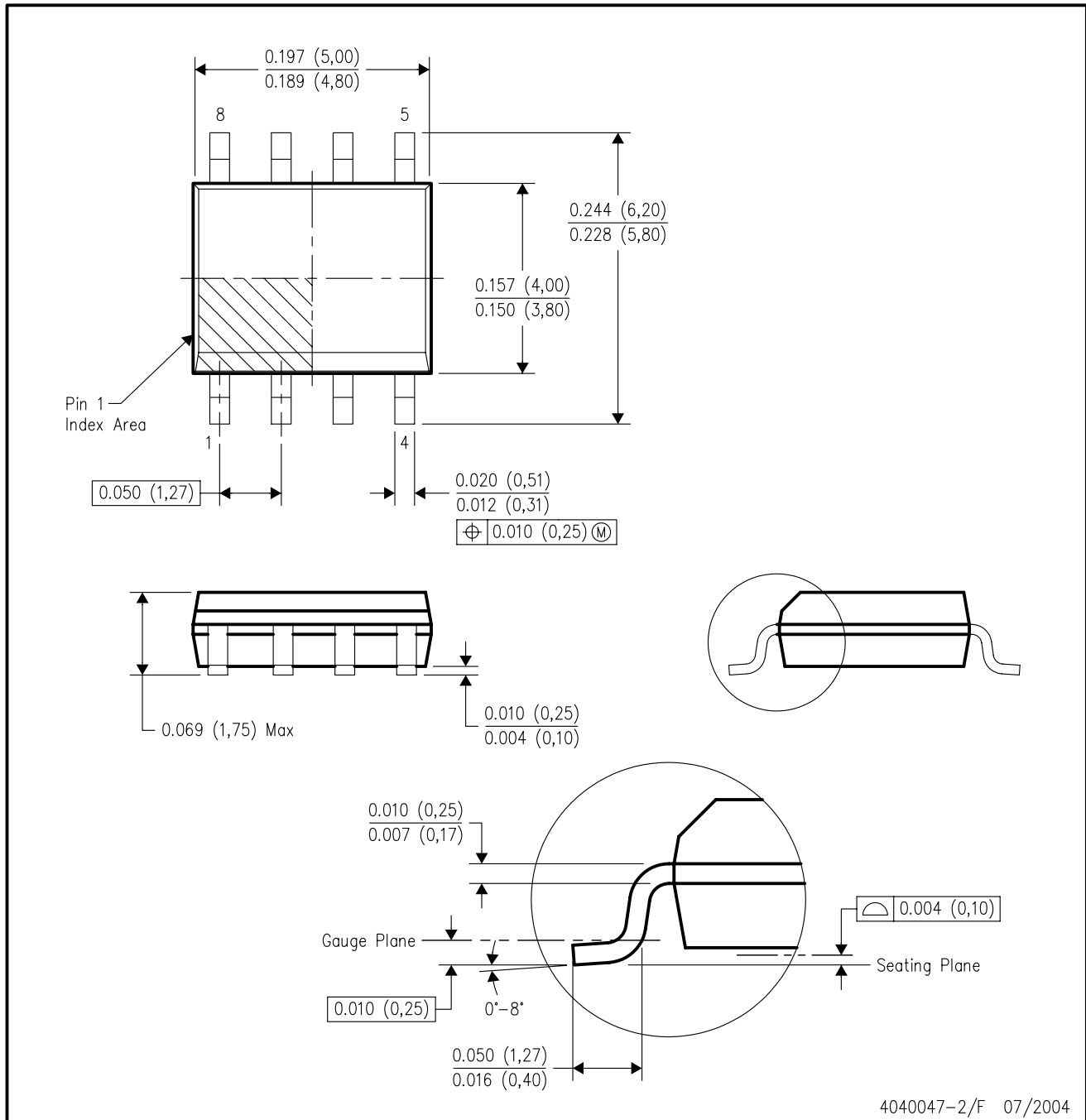

- NOTES:
- A. All linear dimensions are in inches (millimeters).
 - B. This drawing is subject to change without notice.
 - C. Body dimensions do not include mold flash or protrusion not to exceed 0.006 (0,15).
 - D. Falls within JEDEC MS-012 variation AA.

PW (R-PDSO-G**)

PLASTIC SMALL-OUTLINE PACKAGE

14 PINS SHOWN



4040064/F 01/97

- NOTES: A. All linear dimensions are in millimeters.
 B. This drawing is subject to change without notice.
 C. Body dimensions do not include mold flash or protrusion not to exceed 0,15.
 D. Falls within JEDEC MO-153

IMPORTANT NOTICE

Texas Instruments Incorporated and its subsidiaries (TI) reserve the right to make corrections, modifications, enhancements, improvements, and other changes to its products and services at any time and to discontinue any product or service without notice. Customers should obtain the latest relevant information before placing orders and should verify that such information is current and complete. All products are sold subject to TI's terms and conditions of sale supplied at the time of order acknowledgment.

TI warrants performance of its hardware products to the specifications applicable at the time of sale in accordance with TI's standard warranty. Testing and other quality control techniques are used to the extent TI deems necessary to support this warranty. Except where mandated by government requirements, testing of all parameters of each product is not necessarily performed.

TI assumes no liability for applications assistance or customer product design. Customers are responsible for their products and applications using TI components. To minimize the risks associated with customer products and applications, customers should provide adequate design and operating safeguards.

TI does not warrant or represent that any license, either express or implied, is granted under any TI patent right, copyright, mask work right, or other TI intellectual property right relating to any combination, machine, or process in which TI products or services are used. Information published by TI regarding third-party products or services does not constitute a license from TI to use such products or services or a warranty or endorsement thereof. Use of such information may require a license from a third party under the patents or other intellectual property of the third party, or a license from TI under the patents or other intellectual property of TI.

Reproduction of information in TI data books or data sheets is permissible only if reproduction is without alteration and is accompanied by all associated warranties, conditions, limitations, and notices. Reproduction of this information with alteration is an unfair and deceptive business practice. TI is not responsible or liable for such altered documentation.

Resale of TI products or services with statements different from or beyond the parameters stated by TI for that product or service voids all express and any implied warranties for the associated TI product or service and is an unfair and deceptive business practice. TI is not responsible or liable for any such statements.

Following are URLs where you can obtain information on other Texas Instruments products and application solutions:

Products		Applications	
Amplifiers	amplifier.ti.com	Audio	www.ti.com/audio
Data Converters	dataconverter.ti.com	Automotive	www.ti.com/automotive
DSP	dsp.ti.com	Broadband	www.ti.com/broadband
Interface	interface.ti.com	Digital Control	www.ti.com/digitalcontrol
Logic	logic.ti.com	Military	www.ti.com/military
Power Mgmt	power.ti.com	Optical Networking	www.ti.com/opticalnetwork
Microcontrollers	microcontroller.ti.com	Security	www.ti.com/security
		Telephony	www.ti.com/telephony
		Video & Imaging	www.ti.com/video
		Wireless	www.ti.com/wireless

Mailing Address: Texas Instruments
Post Office Box 655303 Dallas, Texas 75265

Copyright © Each Manufacturing Company.

All Datasheets cannot be modified without permission.

This datasheet has been download from :

www.AllDataSheet.com

100% Free DataSheet Search Site.

Free Download.

No Register.

Fast Search System.

www.AllDataSheet.com