



Low-Noise, 14V Input, 1A, PWM Step-Down Converters

MAX1684/MAX1685

General Description

The MAX1684/MAX1685 are high-efficiency, internal-switch, PWM step-down switching regulators intended to power cellular phones, communicating PDAs, and handy-terminals. These devices deliver a guaranteed 1A output current from two Li-Ion batteries. Their wide input voltage range of 2.7V to 14V gives design flexibility and allows batteries to charge from a wall cube, since the ICs operate at the higher voltages that occur when the battery is removed. The output voltage is preset to 3.3V or can be externally adjusted from 1.25V to V_{IN} .

The low-on-resistance power switch and built-in synchronous rectifier provide high efficiencies of up to 96%. There are four modes of operation: fixed-frequency mode, normal mode, low-power mode, and shutdown mode. The fixed-frequency PWM mode of operation offers excellent noise characteristics. The normal mode maintains high efficiency at all loads. The low-power mode is used to conserve power in standby or when full load is not required. The shutdown mode is used to power down the device for minimal current draw.

The MAX1684 runs at 300kHz for applications that require highest efficiency. The MAX1685 runs at 600kHz to allow use of smaller external components. These devices can also be synchronized to an external clock. Other features include a 100% duty cycle for low-dropout applications, an auxiliary 3V/5mA output, and a 1% accurate reference.

Both devices are available in a space-saving 16-QSOP package. An evaluation kit is also available to help speed designs. For a similar device in a 10-pin μ MAX package with lower input voltage requirements (5.5V max), see the MAX1692 data sheet.

Applications

- Cellular Phones
- 2-Way Radios and Walkie-Talkies
- Computer Peripherals
- Personal Communicators
- PDAs and Handy-Terminals

Pin Configuration appears at end of data sheet.

Dual Mode is a trademark of Maxim Integrated Products.



For free samples & the latest literature: <http://www.maxim-ic.com>, or phone 1-800-998-8800. For small orders, phone 1-800-835-8769.

Features

- ◆ Up to 96% Efficiency
- ◆ 1A Guaranteed Output Current
- ◆ 100% Duty Cycle in Dropout
- ◆ 2.7V to 14V Input Range (15V absolute max)
- ◆ $\pm 1\%$ Accurate Reference Output
- ◆ 0.24 Ω P-Channel On-Resistance
- ◆ Synchronizable Switching Frequency
- ◆ Fixed-Frequency PWM Operation
300kHz (MAX1684)
600kHz (MAX1685)
- ◆ 150 μ A Normal Mode Quiescent Current
- ◆ 25 μ A Low-Power Mode Quiescent Current
- ◆ 2 μ A Shutdown Current
- ◆ Dual Mode™ Fixed 3.3V ($\pm 1\%$) Output or Adjustable Output (1.25V to V_{IN})
- ◆ Small 16-QSOP Package
- ◆ Auxiliary Output (CVL): 3V/5mA

Ordering Information

| PART | TEMP. RANGE | PIN-PACKAGE |
|------------|----------------|-------------|
| MAX1684EEE | -40°C to +85°C | 16 QSOP |
| MAX1685EEE | -40°C to +85°C | 16 QSOP |

Typical Operating Circuit

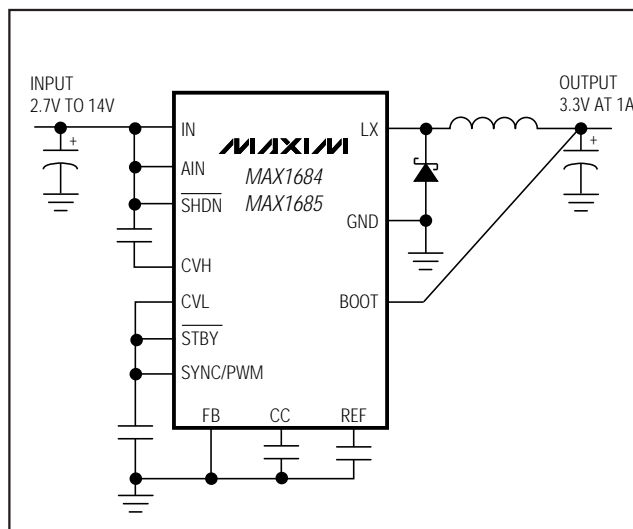

Low-Noise, 14V Input, 1A, PWM Step-Down Converters

ABSOLUTE MAXIMUM RATINGS

| | | | |
|---|------------------------------------|---|-----------------|
| AIN to AGND | -0.3 to +15V | CVL Current | 10mA to -1mA |
| IN to PGND | -0.3V to (V _{AIN} + 0.3V) | LX Peak Current (Internally Limited) | 2.3A |
| LX to PGND | -0.5V to (V _{IN} + 0.3V) | Continuous Power Dissipation (T _A = +70°C) | |
| PGND to AGND | ±0.3V | 16-Pin QSOP (derate 8.3mW/°C above +70°C)..... | 667mW |
| S _H DN to AGND | -0.3V to (V _{AIN} + 0.3V) | Operating Temperature Range | -40°C to +85°C |
| ILIM/SS, FB, CC, BOOT, REF to AGND | -0.3V to (V _{CVL} + 0.3V) | Junction Temperature | +150°C |
| CVH to IN..... | -6V to +0.3V | Storage Temperature Range | -65°C to +150°C |
| CVL, $\overline{\text{STBY}}$, SYNC/PWM to AGND..... | -0.3V to +6V | Lead Temperature (soldering, 10sec) | +300°C |
| Reference Current | ±1mA | | |

Stresses beyond those listed under "Absolute Maximum Ratings" may cause permanent damage to the device. These are stress ratings only, and functional operation of the device at these or any other conditions beyond those indicated in the operational sections of the specifications is not implied. Exposure to absolute maximum rating conditions for extended periods may affect device reliability.

ELECTRICAL CHARACTERISTICS

(V_{IN} = V_{S_HDN} = +6V, $\overline{\text{STBY}}$ = SYNC/PWM = CVL, V_{BOOT} = V_{OUT}, FB = AGND, circuit of Figure 1, T_A = 0°C to +85°C, unless otherwise noted. Typical values are at T_A = +25°C.)

| PARAMETER | SYMBOL | CONDITIONS | | MIN | TYP | MAX | UNITS |
|--|--------------------|---|------------------------|------------------|-------|-----------------|-------|
| Input Voltage Range | | | | 2.7 | | 14 | V |
| Feedback Voltage | V _{FB} | V _{FB} = V _{OUT} , I _{LOAD} = 0 to 1A | | 1.238 | 1.251 | 1.264 | V |
| Output Voltage (3.3V mode) | V _{OUT} | FB = AGND, I _{LOAD} = 0 to 1A | | 3.3 | 3.333 | 3.365 | V |
| Output Load Regulation | | V _{FB} = V _{OUT} , I _{LOAD} = 0 to 1A | | | 0.01 | | % |
| Output Current Capability | | V _{IN} = 5V to 14V | | 1 | | | A |
| Output Adjust Range | | BOOT = AGND (Note 1) | | V _{REF} | | V _{IN} | V |
| FB Input Current | I _{FB} | V _{FB} = 1.4V | | -50 | | 50 | nA |
| On-Resistance, P-Channel | | High-side switch, I _{LX} = 1A | V _{IN} = 6V | | 0.24 | 0.5 | Ω |
| | | | V _{IN} = 2.7V | | 0.34 | 0.8 | |
| On-Resistance, N-Channel | | Low-side switch, V _{IN} = 2.7V, I _{LX} = 200mA | | | 3 | 8 | Ω |
| Current Limit in PWM Mode | I _{LIM} | | | 1.2 | 1.75 | 2.3 | A |
| Pulse-Skipping Current Threshold | | SYNC/PWM = low | | 285 | 380 | 475 | mA |
| Current Limit in Low-Power Mode | I _{LIMLP} | $\overline{\text{STBY}}$ = low | | 285 | 380 | 475 | mA |
| Current Limit, N-Channel | | SYNC/PWM = high | | 0.15 | 0.4 | 0.9 | A |
| Zero Crossing Threshold | | SYNC/PWM = low | MAX1684 | 20 | 50 | 80 | mA |
| | | | MAX1685 | 40 | 80 | 120 | |
| Quiescent Power Consumption | | PWM mode, SYNC/PWM = high, V _{BOOT} = 3.3V (Note 2) | MAX1684 | | 13 | 33 | mW |
| | | | MAX1685 | | 25 | 65 | |
| | | Normal mode, SYNC/PWM = low, V _{BOOT} = 3.3V (Note 2) | | | 0.9 | 2 | |
| Low-power mode, $\overline{\text{STBY}}$ = low, V _{BOOT} = 3.3V (Note 2) | | | 0.14 | 0.27 | | | |

Low-Noise, 14V Input, 1A, PWM Step-Down Converters

MAX1684/MAX1685

ELECTRICAL CHARACTERISTICS (continued)

($V_{IN} = V_{SHDN} = +6V$, $\overline{STBY} = SYNC/PWM = CVL$, $V_{BOOT} = V_{OUT}$, $FB = AGND$, circuit of Figure 1, $T_A = 0^{\circ}C$ to $+85^{\circ}C$, unless otherwise noted. Typical values are at $T_A = +25^{\circ}C$.)

| PARAMETER | SYMBOL | CONDITIONS | MIN | TYP | MAX | UNITS | |
|---------------------------------------|-----------|--|---------|-------|-------|-------------|---|
| Quiescent Supply Current in Dropout | | $\overline{STBY} = \text{low}$, $V_{IN} = 2.7V$ | | 230 | 430 | μA | |
| Shutdown Supply Current | | $\overline{SHDN} = \text{low}$ | | 2 | 6 | μA | |
| LX Leakage Current | I_{LX} | $V_{IN} = 14V$, $V_{LX} = 0$ or $14V$, $\overline{SHDN} = \text{low}$ | | | 20 | μA | |
| Oscillator Frequency | f_{OSC} | MAX1684 | 260 | 300 | 340 | kHz | |
| | | MAX1685 | 520 | 600 | 680 | | |
| SYNC Capture Range | | MAX1684 | 180 | | 350 | kHz | |
| | | MAX1685 | 360 | | 700 | | |
| Maximum Duty Cycle | | | 100 | | | % | |
| Constant-Frequency Minimum Duty Cycle | | (Note 3) | MAX1684 | 10 | | | % |
| | | | MAX1685 | 20 | | | |
| Reference Output Voltage | V_{REF} | $I_{REF} = 0$ | 1.238 | 1.251 | 1.264 | V | |
| Reference Load Regulation | | $-1\mu A < I_{REF} < 50\mu A$ | | 4 | 15 | mV | |
| Reference Supply Regulation | | $2.7V < V_{BOOT} < 5.5V$ | | 0.2 | 5 | mV | |
| CVL Regulator Output Voltage | | $V_{IN} = 3V$ to $14V$, $\overline{BOOT} = AGND$, $I_{CVL} = 0$ to $5mA$ | 2.7 | 3.0 | 3.15 | V | |
| CVL Dropout Voltage | | $\overline{BOOT} = AGND$, $I_{CVL} = 5mA$ | | | 120 | mV | |
| CVL Undervoltage Lockout Threshold | | $\overline{BOOT} = AGND$, CVL falling edge, typical hysteresis is 40mV | 2.4 | 2.5 | 2.6 | V | |
| CVH with Respect to V_{IN} | | $I_{CVH} = -1mA$ | -5.0 | -4.6 | -4.1 | V | |
| BOOT Switchover Threshold | | \overline{BOOT} falling edge, typical hysteresis is 0.1V | 2.4 | 2.5 | 2.6 | V | |
| Thermal Shutdown Threshold | | Typical hysteresis is $10^{\circ}C$ (Note 4) | | 160 | | $^{\circ}C$ | |
| ILIM/SS Source Current | | $V_{ILIM/SS} = 1.4V$ | 3.3 | 4 | 4.65 | μA | |
| Logic Input High Voltage | V_{IH} | \overline{SHDN} , \overline{STBY} , SYNC/PWM | 2 | | | V | |
| Logic Input Low Voltage | V_{IL} | | | | 0.7 | V | |
| Logic Input Current | | \overline{SHDN} , \overline{STBY} , SYNC/PWM | -1 | | 1 | μA | |
| SYNC/PWM Pulse Width | | High or low period | 500 | | | ns | |

Low-Noise, 14V Input, 1A, PWM Step-Down Converters

ELECTRICAL CHARACTERISTICS

($V_{IN} = V_{SHDN} = +6V$, $\overline{STBY} = SYNC/PWM = CVL$, $V_{BOOT} = V_{OUT}$, $FB = AGND$, circuit of Figure 1, $T_A = -40^{\circ}C$ to $+85^{\circ}C$, unless otherwise noted.) (Note 5)

| PARAMETER | SYMBOL | CONDITIONS | MIN | MAX | UNITS |
|------------------------------------|-------------|--|-----------|----------|---------|
| Input Voltage Range | | | 2.7 | 14 | V |
| Output Feedback Voltage | V_{FB} | $V_{FB} = V_{OUT}$, $I_{LOAD} = 0$ to 1A | 1.236 | 1.266 | V |
| Output Voltage (3.3V mode) | V_{OUT} | $FB = AGND$, $I_{LOAD} = 0$ to 1A | 3.295 | 3.375 | V |
| Output Current Capability | | $V_{IN} = 6V$ to 14V | 1 | | A |
| Output Adjust Range | | $BOOT = AGND$ (Note 1) | V_{REF} | V_{IN} | V |
| FB Input Current | I_{FB} | $V_{FB} = 1.4V$ | -50 | 50 | nA |
| Current Limit in PWM Mode | I_{LIM} | | 1.2 | 2.3 | A |
| Current Limit in Low-Power Mode | I_{LIMLP} | $\overline{STBY} = low$ | 285 | 475 | mA |
| Quiescent Power Consumption | | Normal mode, $SYNC/PWM = low$, $V_{BOOT} = 3.3V$ (Note 2) | | 2 | mW |
| | | Low-power mode, $\overline{STBY} = low$, $V_{BOOT} = 3.3V$ (Note 2) | | 0.27 | |
| Shutdown Supply Current | | $\overline{SHDN} = low$ | | 6 | μA |
| Oscillator Frequency | f_{OSC} | MAX1684 | 240 | 350 | kHz |
| | | MAX1685 | 480 | 700 | |
| Reference Output Voltage | | $I_{REF} = 0$ | 1.236 | 1.266 | V |
| CVL Regulator Output Voltage | | $V_{IN} = 3V$ to 14V, $BOOT = AGND$, $I_{CVL} = 0$ to 5mA | 2.7 | 3.15 | V |
| CVL Undervoltage Lockout Threshold | | $BOOT = AGND$, CVL falling edge, typical hysteresis is 40mV | 2.4 | 2.6 | V |
| CVH with Respect to V_{IN} | | $I_{CVH} = -1mA$ | -5.0 | -4.1 | V |
| BOOT Switchover Threshold | | BOOT falling edge, typical hysteresis is 0.1V | 2.4 | 2.6 | V |
| ILIM/SS Source Current | | $V_{LIM/SS} = 1.4V$ | 3.1 | 4.7 | μA |
| Logic Input High Voltage | V_{IH} | \overline{SHDN} , \overline{STBY} , $SYNC/PWM$ | 2 | | V |
| Logic Input Low Voltage | V_{IL} | | | 0.7 | |

Note 1: The output adjust range with $BOOT$ connected to V_{OUT} is V_{REF} to 5.5V. Connect $BOOT$ to $AGND$ for $V_{OUT} > 5.5V$.

Note 2: The quiescent power-consumption specifications include chip supply and gate-drive loss only. Divide these values by V_{IN} (= 6V) to obtain quiescent currents. In normal and low-power modes, chip supply current dominates and quiescent power is proportional to V_{BOOT} ($BOOT$ connected to OUT). In PWM mode, gate-drive loss dominates and quiescent power is proportional to $V_{IN} \cdot (V_{IN} - V_{CVH})$. In addition, IR losses in power switches and external components typically increase PWM quiescent power consumption by 5mW to 10mW. Note that if the device is not bootstrapped, additional power will be dissipated in the CVL linear regulator.

Note 3: When the duty factor (V_{OUT} / V_{IN}) is less than this value, the switching frequency decreases in PWM mode to maintain regulation.

Note 4: Thermal shutdown is disabled in low-power mode ($\overline{STBY} = low$) to reduce power consumption.

Note 5: Specifications to $-40^{\circ}C$ are guaranteed by design, not production tested.

Low-Noise, 14V Input, 1A, PWM Step-Down Converters

Typical Operating Characteristics

(Circuit of Figure 1, $T_A = +25^\circ\text{C}$, unless otherwise noted.)

MAX1684/MAX1685

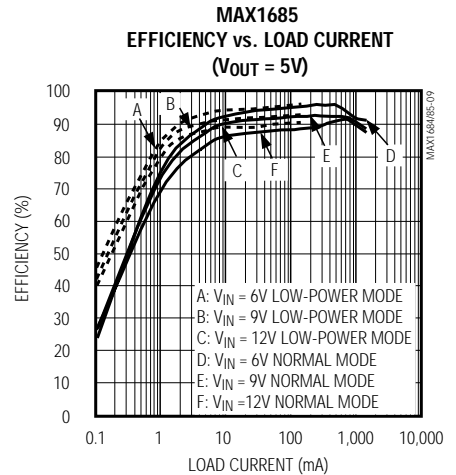
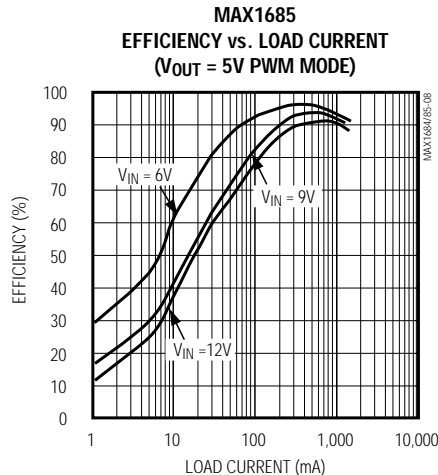
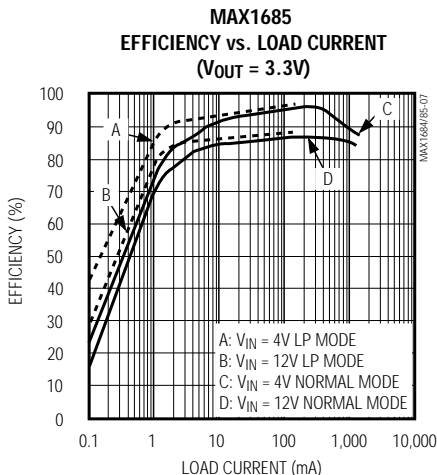
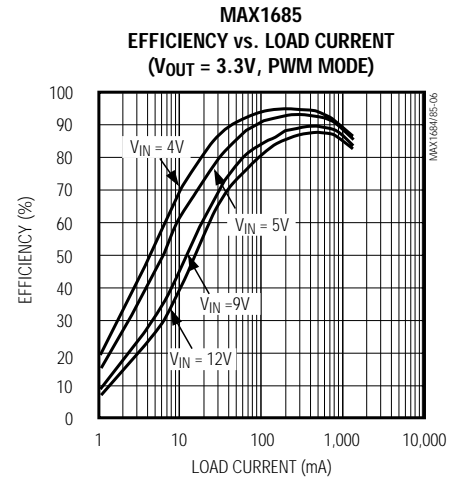
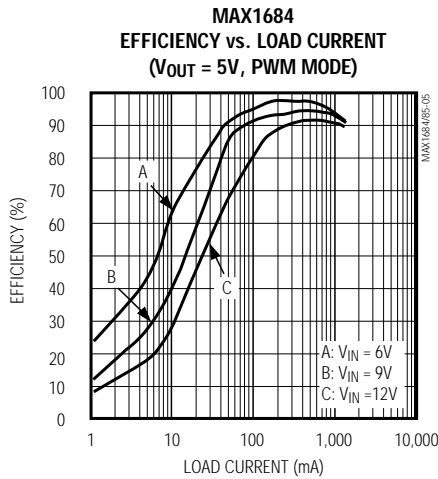
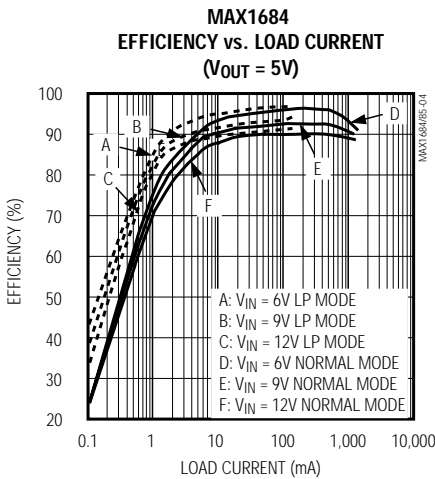
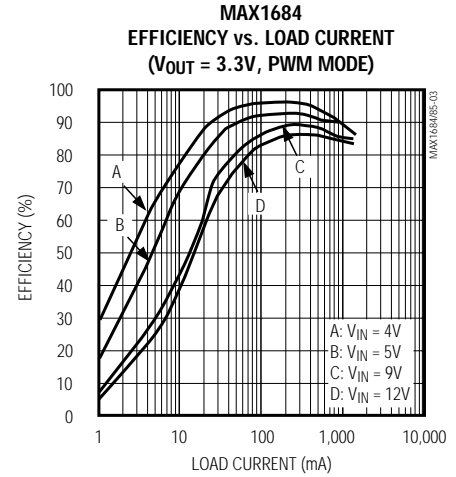
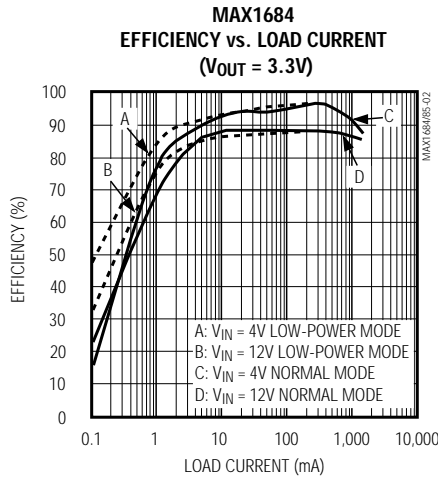
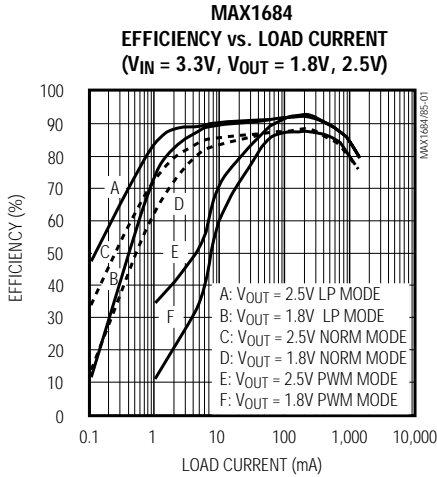

Low-Noise, 14V Input, 1A, PWM Step-Down Converters

Typical Operating Characteristics (continued)

(Circuit of Figure 1, $T_A = +25^\circ\text{C}$, unless otherwise noted.)

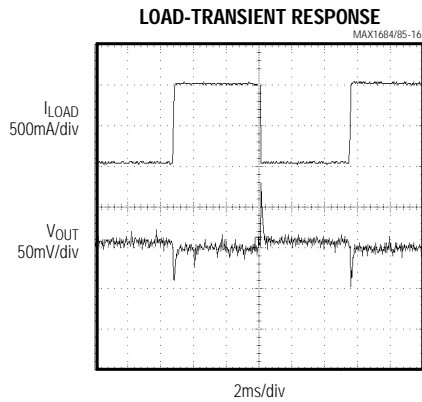
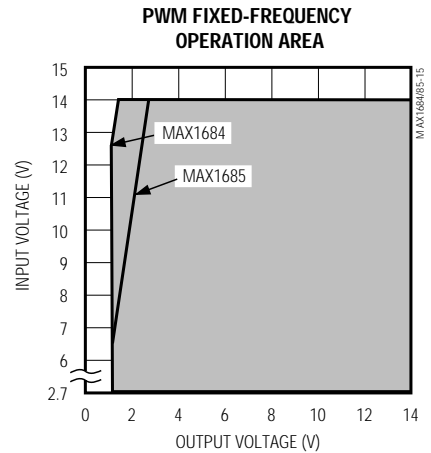
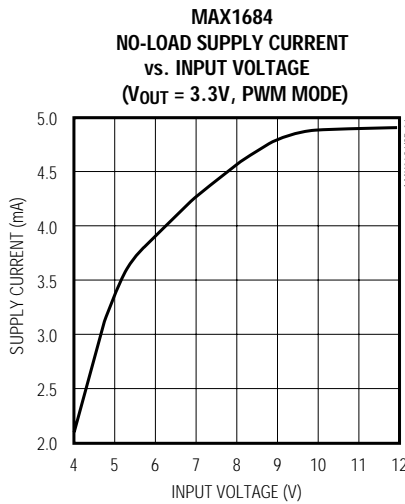
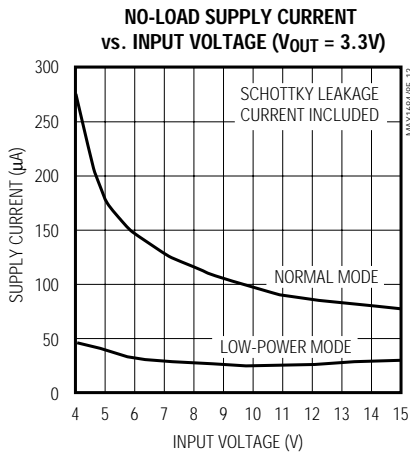
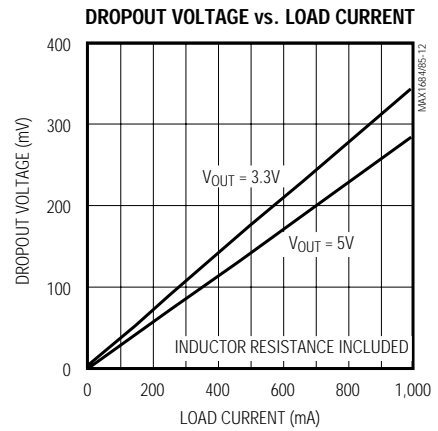
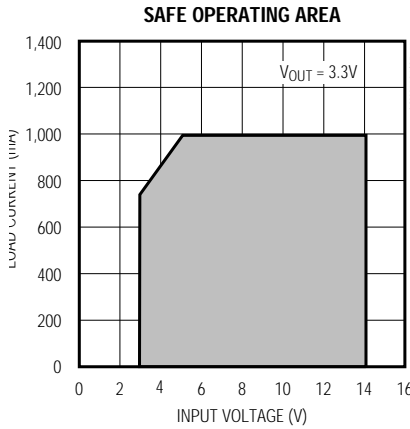
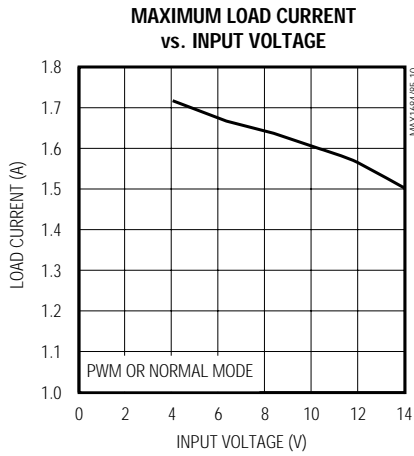

MAX1684, $I_{LOAD} = 0.1\text{mA TO } 1\text{A}$, $V_{OUT} = 3.3\text{V}$, $V_{IN} = 5\text{V}$, SYNC/PWM = 3.3V

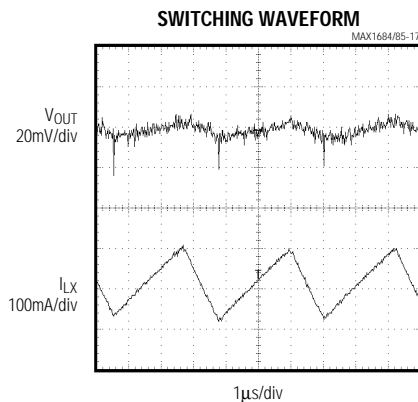

MAX1684, $I_{LOAD} = 100\text{mA}$, $V_{OUT} = 3.3\text{V}$, $V_{IN} = 5\text{V}$, SYNC/PWM = 3.3V

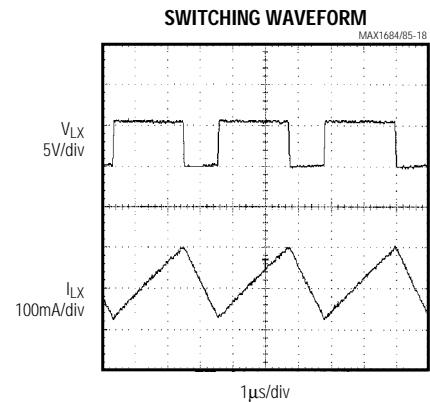

MAX1684, $I_{LOAD} = 100\text{mA}$, $V_{OUT} = 3.3\text{V}$, $V_{IN} = 5\text{V}$, SYNC/PWM = 3.3V

Low-Noise, 14V Input, 1A, PWM Step-Down Converters

Typical Operating Characteristics (continued)

(Circuit of Figure 1, $T_A = +25^\circ\text{C}$, unless otherwise noted.)

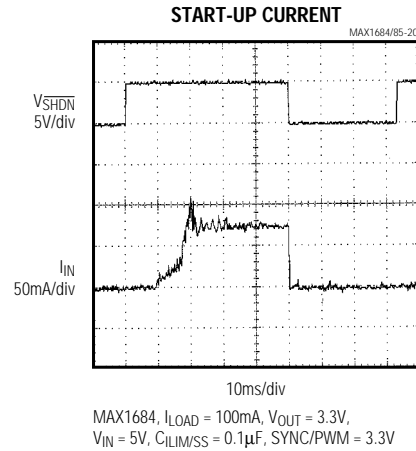
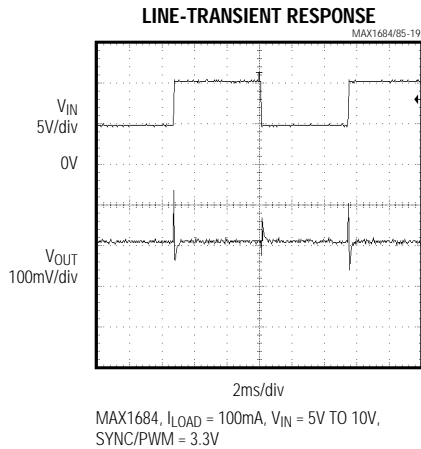

MAX1684/MAX1685

Pin Description

| PIN | NAME | FUNCTION |
|--------|--------------------------|---|
| 1 | CVH | High-Side MOSFET Gate Bias. Bias voltage for P-channel switch. Bypass to IN with a 0.1 μF capacitor. |
| 2 | AIN | Analog Supply Voltage Input. Connect to IN with a 0.2 in. metal trace. Bypass to PGND with a 0.1 μF capacitor. |
| 3 | IN | Supply Voltage Input |
| 4 | CVL | Logic Supply Voltage Output and IC Logic Supply. Sources 5mA for external loads. Bypass to AGND with 1 μF capacitor. |
| 5 | AGND | Analog Ground |
| 6 | REF | Reference Output. 1.25V reference output supplies 10 μA for external loads. Bypass to AGND with 0.1 μF capacitor. |
| 7 | FB | Dual Mode Feedback Input. Connect FB to V_{OUT} for 1.25V output. Connect to an external resistor divider to adjust the output voltage. Connect to AGND to set output voltage to 3.3V. |
| 8 | CC | Integrator Capacitor Connection. Connect a 0.01 μF capacitor to AGND. |
| 9 | SYNC/PWM | SYNC/PWM Input: For synchronized-PWM operation, drive with TTL level, 50% square wave. Connect to CVL for PWM mode. Connect to AGND for normal mode. |
| 10 | ILIM/SS | Current-Limit Adjust/Soft-Start Input. See <i>Current Limit and Soft-Start</i> section. |
| 11 | $\overline{\text{STBY}}$ | Standby Control Input. Connect to CVL for normal operation. Connect to AGND for low-power mode (Table 1). This pin overrides SYNC/PWM setting. |
| 12 | BOOT | Bootstrap Input. Connection for the bootstrap switch and internal feedback path. Connect BOOT to V_{OUT} for $V_{OUT} < 5.5\text{V}$. Connect BOOT to AGND for $V_{OUT} > 5.5\text{V}$. |
| 13, 14 | LX | Inductor Connection. Drain for internal P-channel MOSFETs. Connect inductor from LX to OUT. |
| 15 | $\overline{\text{SHDN}}$ | Active-Low Shutdown Input. Connect to ground for shutdown. $\overline{\text{SHDN}}$ can withstand the input voltage. |
| 16 | PGND | Power Ground |

Low-Noise, 14V Input, 1A, PWM Step-Down Converters

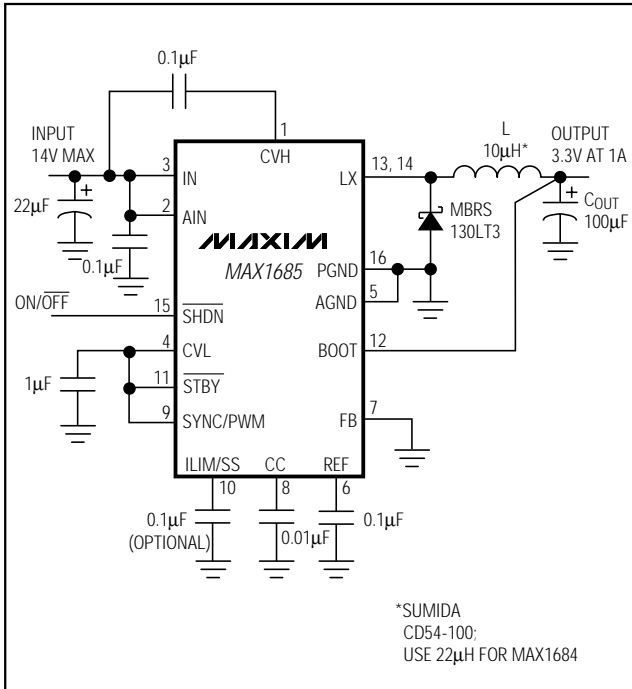

Figure 1. Standard Application Circuit

Detailed Description

The MAX1684/MAX1685 step-down, pulse-width-modulation (PWM) DC-DC converters provide an adjustable output from 1.25V to the input voltage. They accept inputs from 2.7V to 14V and deliver up to 1.6A. An internal MOSFET and synchronous rectifier reduce PC board area while maintaining high efficiency. Operation with up to 100% duty cycle minimizes dropout voltage. Fixed-frequency PWM operation reduces interference in sensitive communications and data-acquisition appli-

cations. A SYNC input allows synchronization to an external clock. The MAX1684/MAX1685 can operate in five modes. Setting the devices to operate in the appropriate mode for the intended application (Table 1) achieves highest efficiency.

PWM Control

The MAX1684/MAX1685 use an oscillator-triggered minimum/maximum on-time current-mode control scheme (Figure 2). The minimum on-time is typically 220ns unless the regulator is in dropout. The maximum on-time is $2 / f_{OSC}$, allowing operation to 100% duty cycle. Current-mode feedback provides cycle-by-cycle current limiting for superior load- and line-transient response.

At each falling edge of the internal oscillator, the internal P-channel MOSFET (main switch) turns on. This allows current to ramp up through the inductor to the load and stores energy in a magnetic field. The switch remains on until either the current-limit comparator trips, the maximum on-time expires, or the PWM comparator signals that the output is in regulation. When the switch turns off during the second half of each cycle, the inductor's magnetic field collapses, releasing the stored energy and forcing current through the output diode to the output filter capacitor and load. The output filter capacitor stores charge when the inductor current is high and releases it when the inductor current is low, smoothing the voltage across the load.

During normal operation, the MAX1684/MAX1685 regulate the output voltage by switching at a constant frequency and modulating the power transferred to the load on each cycle using the PWM comparator. A multi-input comparator sums three weighted differential signals (the output voltage with respect to the reference, the main switch current sense, and the slope-compensation ramp) and changes states when a threshold is reached. It modulates output power by adjusting the

Table 1. Operating Modes

| MODE | SYNC/PWM | \overline{STBY} | \overline{SHDN} | FUNCTION | TYPICAL OUTPUT CAPABILITY |
|-----------|----------|-------------------|-------------------|---|---------------------------|
| PWM | H | H | H | Fixed-Frequency PWM | 1.6A |
| Sync PWM | Clocked | H | H | Fixed-Input Clock-Frequency PWM | 1.6A |
| Normal | L | H | H | PFM at light loads (<150mA). Fixed-frequency PWM at heavy loads (>150mA). | 1.6A |
| Low Power | X | L | H | Low-Power or Standby Mode. | 160mA |
| Shutdown | X | X | L | Circuit Disabled | 0 |

Low-Noise, 14V Input, 1A, PWM Step-Down Converters

MAX1684/MAX1685

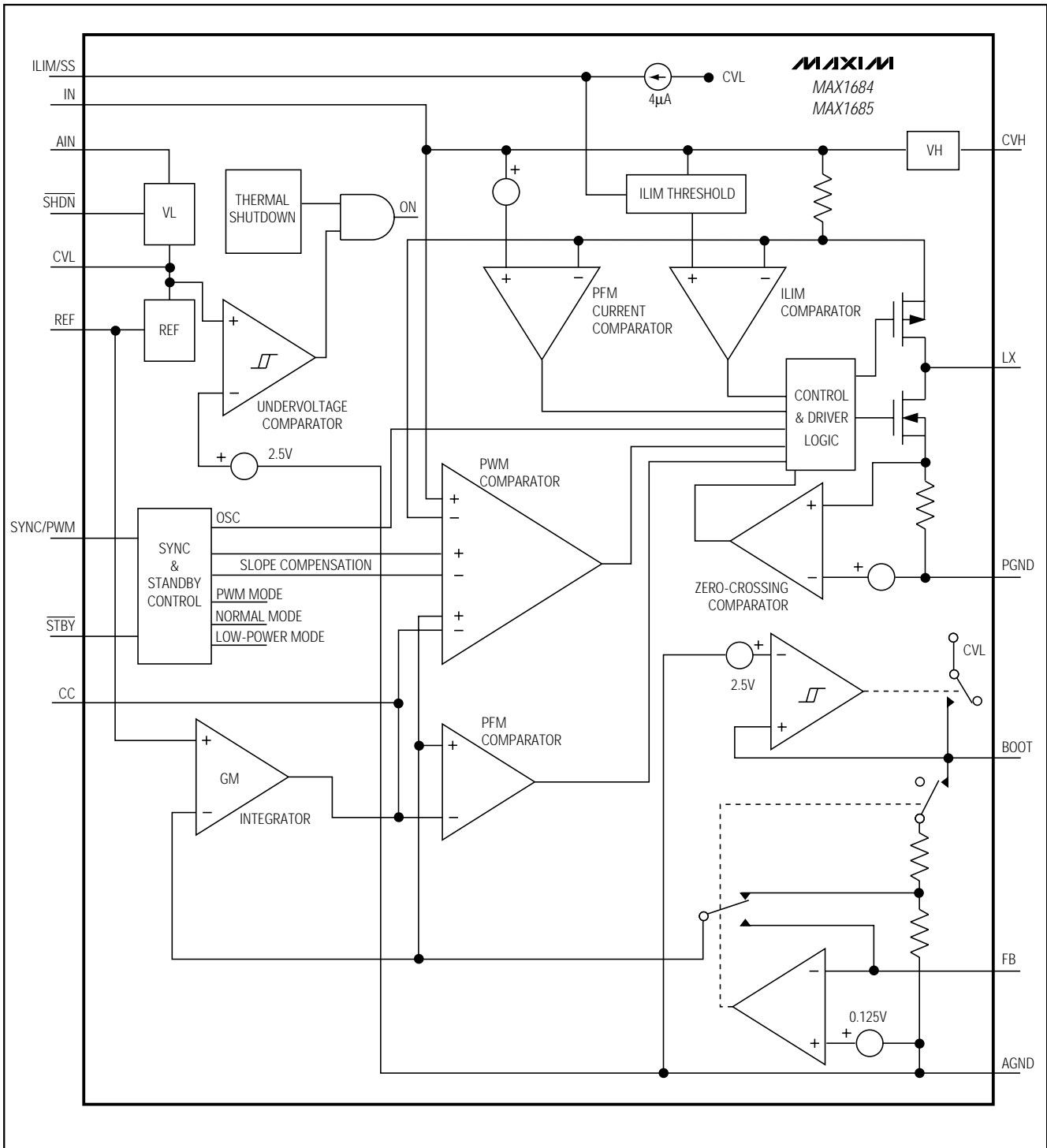

Figure 2. Functional Diagram

Low-Noise, 14V Input, 1A, PWM Step-Down Converters

inductor peak current during the first half of each cycle, based on the output error voltage. The MAX1684/MAX1685's loop gain is relatively low to enable the use of a small, low-valued output filter capacitor. The 1.4% transient load regulation from 0 to 1A is compensated by an integrator circuit that lowers DC load regulation to 0.01% typical. Slope compensation accounts for the inductor-current waveform's down slope during the second half of each cycle, and eliminates the inductor-current staircasing characteristic of current-mode controllers at high duty cycles.

PFM Control

In low-power mode, the MAX1684/MAX1685 devices switch only as needed to service the load. This reduces the switching frequency and associated losses in the P-channel switch, the synchronous rectifier, and the external inductor. During this PFM operation, a switching cycle initiates when the PFM comparator senses that the output voltage has dropped too low. The P-channel MOSFET switch turns on and conducts current to the output-filter capacitor and load. The MAX1684/MAX1685 then wait until the PFM comparator senses a low output voltage again.

In normal mode at light load (<150mA), the device also operates in PFM. The PFM current comparator controls both entry into PWM mode and the peak switch current during PFM operation. Consequently, some jitter is normal during transition from PFM to PWM with loads around 150mA, and it has no adverse impact on regulation.

100% Duty-Cycle Operation

As the input voltage drops, the duty cycle increases until the P-channel MOSFET turns on continuously, achieving 100% duty cycle. Dropout voltage in 100% duty cycle is the output current multiplied by the on-resistance of the internal switch and inductor, approximately 0.35V ($I_{OUT} = 1A$).

Very Low Duty-Cycle Operation

Because of the P-channel minimum on-time and dead-time (duration when both switches are off), the MAX1684/MAX1685's switching frequency must decrease in PWM or normal mode to maintain regulation at a very low duty cycle. The total P-channel on-time and dead-time is 290ns typical. As a result, the MAX1684/MAX1685 will maintain fixed-frequency regulation at no load for V_{IN} up to $10V_{OUT}$ and $5V_{OUT}$, respectively (see PWM Fixed-Frequency Operation Area graph in the *Typical Operating Characteristics*). For higher V_{IN} at no

load, the frequency decreases based on the following equation:

$$f = V_{OUT} / (V_{IN} \cdot 290ns)$$

At medium- to full-load current (>100mA), V_{IN} can increase slightly higher before the frequency decreases.

Synchronous Rectification

Although the primary rectifier is an external Schottky diode, a small internal N-channel synchronous rectifier allows PWM operation at light loads. During the second half of each cycle, when the inductor current ramps below the zero-crossing threshold or when the oscillator period ends, the synchronous rectifier turns off. This keeps excess current from flowing backward through the inductor. Choose an appropriate inductor to limit the PWM ripple current through the N-channel FET to 400mA_{p-p}.

Current Limit and Soft-Start

The voltage at ILIM/SS sets the PWM current limit ($I_{LIM} = 1.75A$) and the low-power current limit ($I_{LIMLP} = 380mA$). The PWM current limit applies when the device is in PWM mode, in synchronized PWM mode, or delivering a heavy load in normal mode (Table 1). The I_{LIMLP} limit applies when the device is in low-power mode. An internal 4μA current source pulls ILIM/SS up to CVL. To use the maximum current-limit thresholds, leave ILIM/SS unconnected or connect it to a soft-start capacitor. Connect an external resistor from ILIM/SS to AGND to adjust the current-limit thresholds.

The PWM current-limit threshold is $(I_{LIM} \cdot R_{ILIM/SS} \cdot 4\mu A) / V_{REF}$ and is adjustable from 0.5A to 1.75A.

The low-power current-limit threshold is equal to $(I_{LIMLP} \cdot R_{ILIM/SS} \cdot 4\mu A) / V_{REF}$ and is adjustable from 110mA to 380mA.

For example, when $R_{ILIM/SS}$ is 156kΩ, the PWM current limit threshold is 0.88A and the low-power current limit threshold is 0.19A.

Connect a low-value capacitor from ILIM/SS to AGND to achieve soft-start, limiting inrush current. ILIM/SS internally shorts to AGND in shutdown to discharge the soft-start capacitor. Do not connect ILIM/SS to REF or CVL. Determine the soft-start duration by:

$$t_{SOFT-START} = C_{ILIM/SS}(1.25V / 4\mu A)$$

where $t_{SOFT-START}$ is the time from SHDN going high to the regulator being able to supply full load current. For example, a 0.1μF capacitor yields 31ms of soft-start.

Low-Noise, 14V Input, 1A, PWM Step-Down Converters

The output current capability for each mode is determined by the following equations:

$$I_{OUTMAX} = I_{LIM} - 0.5 \cdot I_{RIPPLE} \text{ (for PWM and normal modes)}$$

$$I_{OUTMAX} = 0.5 \cdot I_{LIMLP} \text{ (for low-power mode)}$$

where:

$$I_{RIPPLE} = \text{ripple current} = (V_{IN} - V_{OUT}) \cdot V_{OUT} / (V_{IN} \cdot f_{OSC} \cdot L)$$

I_{LIM} = current limit in PWM mode

I_{LIMLP} = current limit in low-power mode.

Internal Low-Voltage Regulators and Bootstrap (BOOT)

The MAX1684/MAX1685 have two internal regulators (VH and VL) that generate low-voltage supplies for internal circuitry (*Functional Diagram*). The VH regulator generates -4.6V with respect to IN to supply the P-channel switch and driver. Bypass CVH to IN with a 0.1μF capacitor. The VL regulator generates a 3V output at CVL to supply internal low-voltage blocks, as well as the N-channel switch and driver. Bypass CVL to AGND with a 1μF capacitor.

To reduce the quiescent current in low-power and normal modes, connect BOOT to OUT. After start-up, when V_{BOOT} exceeds 2.6V, the internal bootstrap switch connects CVL to BOOT. This bootstrap mechanism causes the internal circuitry to be supplied from the output and thereby reduces the input quiescent current by a factor of V_{OUT} / V_{IN} . Do not connect BOOT to OUT if the output voltage exceeds 5.5V. Instead, connect BOOT to AGND to keep CVL regulated at 3V.

Apply an external supply voltage, such as +3.3V or +5V, to BOOT to achieve a bootstrap effect when the output voltage is too low to bootstrap the device (below 2.7V).

CVL has a 5mA capability to supply external logic circuitry and is disabled in shutdown mode.

Applications Information

Output Voltage Selection

Connect FB to AGND to select the internal 3.3V output mode. Connect BOOT to OUT in this configuration.

To select an output voltage between 1.25V and V_{IN} , connect FB to a resistor voltage divider between the output and AGND (Figure 3). Select R2 in the 20kΩ to 100kΩ range. Calculate R1 as follows:

$$R1 = R2 [(V_{OUT} / V_{FB}) - 1]$$

where $V_{FB} = 1.25V$.

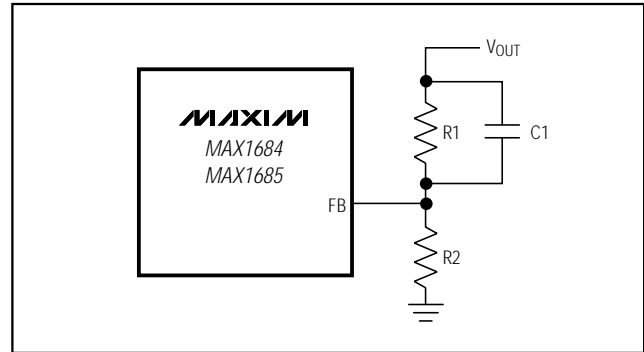

Figure 3. Setting Output Voltage

Connect a small capacitor across R1 to compensate for stray capacitance at the FB pin.

$$C1 = \frac{5 (10^{-7})}{R2}$$

For $R2 = 100k\Omega$, use 4.7pF.

Inductor Selection

The MAX1684/MAX1685's high switching frequency allows the use of small surface-mount inductors. Table 2 shows a selection of suitable inductors for different output voltage ranges. Calculate the minimum inductor by:

$$L = 0.9(V_{OUT} - 0.3V) / (I_{RIPPLE MAX} \cdot f_{OSC})$$

where:

$I_{RIPPLE MAX}$ = should be less than or equal to 400mA

$f_{OSC} = 300kHz$ (MAX1684) or $600kHz$ (MAX1685)

Capacitor Selection

Select input and output filter capacitors to service inductor currents while minimizing voltage ripple. The input filter capacitor reduces peak currents and noise at the voltage source. The MAX1684/MAX1685's loop gain is relatively low, to enable the use of small, low-value output filter capacitors. Higher capacitor values provide improved output ripple and transient response.

Low-ESR capacitors are recommended. Capacitor ESR is a major contributor to output ripple (usually more than 60%). Avoid ordinary aluminum electrolytic capacitors, as they typically have high ESR. Low-ESR aluminum electrolytic capacitors are acceptable and relatively inexpensive. Low-ESR tantalum capacitors are better and provide a compact solution for space-constrained surface-mount designs. Do not exceed the ripple-current ratings of tantalum capacitors. Ceramic capacitors

Low-Noise, 14V Input, 1A, PWM Step-Down Converters

offer the lowest ESR overall. Sanyo OS-CON capacitors have the lowest ESR of the high-value electrolytic types. Use ceramic and OS-CON capacitors for very compact, high-reliability, or wide-temperature applications, where expense is justified. When using very low-ESR capacitors, such as ceramic or OS-CON, check for stability while examining load-transient response, and increase the output compensation capacitor if needed. Table 3 lists suppliers for the various components used with the MAX1684/MAX1685.

Ensure that the minimum capacitance value and maximum ESR values are met:

$$C_{OUT} > I_{OUT\ MAX} / (V_{OUT} \cdot AC\ Load\ Reg \cdot f_{OSC})$$

$$RESR < 2 \cdot AC\ Load\ Reg \cdot V_{OUT}/I_{OUT\ MAX}$$

where $I_{OUT\ MAX} = 1A$, $AC\ Load\ Reg \cong 1.4\%$, and $f_{OSC} = 300kHz$ (MAX1684) or $600kHz$ (MAX1685).

Output Diode Selection

Use a 1A external Schottky diode (MBRS130LT3 or equivalent) for the output rectifier to pass inductor current during the start of the second half of each cycle. This diode operates before the internal N-channel MOSFET completely turns on and during high-current operation. Use a Schottky diode to avoid forward biasing the internal body diode of the N-channel MOSFET.

Table 2. Inductor and Minimum Output Capacitor Selection

| V _{OUT} (V) | MAX1684 (300kHz) | | MAX1685 (600kHz) | |
|----------------------|------------------|---------------------------|------------------|---------------------------|
| | L (μH) | MIN C _{OUT} (μF) | L (μH) | MIN C _{OUT} (μF) |
| 1.25 to 2.7 | 22 | 220 | 10 | 100 |
| 2.7 to 4 | 22 | 100 | 10 | 47 |
| 4 to 6 | 47 | 68 | 22 | 33 |
| 6 to 14 | 68 | 47 | 33 | 22 |

Table 3. Component Suppliers

| SUPPLIER | PHONE | FAX |
|-------------------|--------------|--------------|
| CAPACITORS | | |
| AVX | 803-946-0690 | 803-626-3123 |
| Matsuo | 714-969-2591 | 714-960-6492 |
| Sanyo | 619-661-6835 | 619-661-1055 |
| Sprague | 603-224-1961 | 603-224-1430 |
| INDUCTORS | | |
| Sumida | 847-956-0666 | 847-956-0702 |
| Coilcraft | 847-639-6400 | 847-639-1469 |
| Murata-Erie | 814-237-1431 | 814-238-0490 |
| Sumida | 847-956-0666 | 847-956-0702 |
| TDK | 847-390-4373 | 847-390-4428 |
| DIODES | | |
| Motorola | 602-303-5454 | 602-994-6430 |

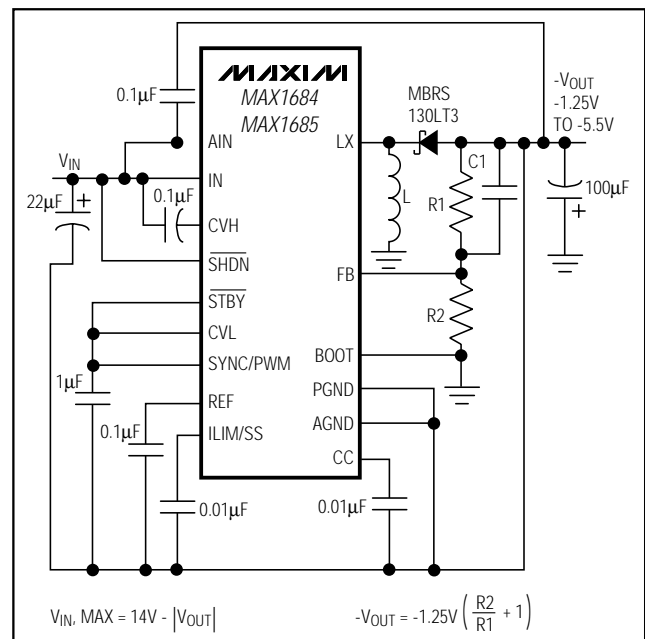

Figure 4. Inverting Output

Low-Noise, 14V Input, 1A, PWM Step-Down Converters

Inverting Output

Interchanging the ground and V_{OUT} connections yields a negative voltage supply (Figure 4). The component selections are the same as for a positive voltage converter. The absolute maximum ratings limit the output voltage range to $-1.25V$ to $+5.5V$ and the maximum input voltage range to $14V - |V_{OUT}|$.

PC Board Layout

High switching frequencies and large peak currents make PC board layout a very important part of design. Poor design can result in excessive EMI on the feedback paths and voltage gradients in the ground plane, both of which result in instability or regulation errors. Power components such as the MAX1684/MAX1685 inductor, input filter capacitor, and output filter capacitor should be placed as close together as possible, and their traces kept short, direct, and wide. Connect their ground nodes in a star-ground configuration. Keep the extra copper on the board and integrate into ground as a pseudo-ground plane.

When using external feedback, the feedback network should be close to FB, within 0.2 inch (5mm), and the output voltage feedback should be tapped as close to the output capacitor as possible. Keep noisy traces, such as those from LX, away from the voltage feedback network. Separate the noisy traces by grounded copper. Place the small bypass capacitors within 0.2 inch (5mm) of their respective inputs. The MAX1684 evaluation kit manual illustrates an example PC board layout, routing, and pseudo-ground plane.

Connect AIN to IN with a short (0.2 inch) metal trace or a 1Ω resistor and bypass AIN to PGND with a $0.1\mu F$ capacitor. This acts as a lowpass filter to reduce noise at AIN.

Pin Configuration

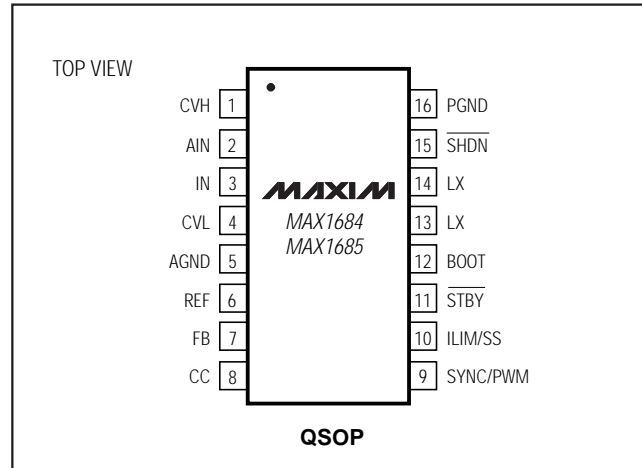

MAX1684/MAX1685

Chip Information

TRANSISTOR COUNT: 2061

Low-Noise, 14V Input, 1A, PWM Step-Down Converters

Package Information

OSOP.EPS

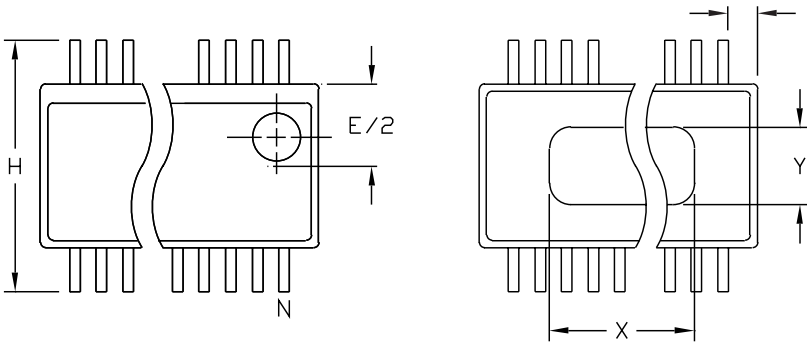

| DIM | INCHES | | MILLIMETERS | |
|-----|----------------|-------|-------------|-------|
| | MIN | MAX | MIN | MAX |
| A | .061 | .068 | 1.55 | 1.73 |
| A1 | .004 | .0098 | 0.102 | 0.249 |
| A2 | .055 | .061 | 1.40 | 1.55 |
| B | .008 | .012 | 0.20 | 0.31 |
| C | .0075 | .0098 | 0.191 | 0.249 |
| D | SEE VARIATIONS | | | |
| E | .150 | .157 | 3.81 | 3.99 |
| e | .025 BSC | | 0.635 BSC | |
| H | .230 | .244 | 5.84 | 6.20 |
| h | .010 | .016 | 0.25 | 0.41 |
| L | .016 | .035 | 0.41 | 0.89 |
| N | SEE VARIATIONS | | | |
| X | SEE VARIATIONS | | | |
| Y | .071 | .087 | 1.803 | 2.209 |
| α | 0° | 8° | 0° | 8° |

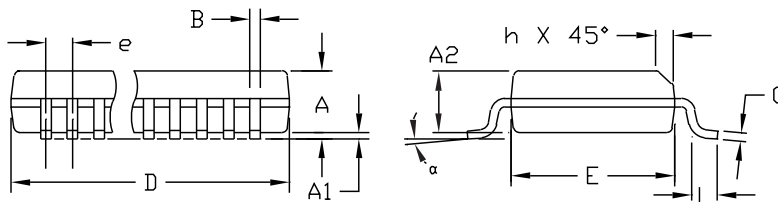

VARIATIONS:

| DIM | INCHES | | MILLIMETERS | | N |
|-----|--------|-------|-------------|-------|---------|
| | MIN. | MAX. | MIN. | MAX. | |
| D | .189 | .196 | 4.80 | 4.98 | 16 AA |
| S | .0020 | .0070 | 0.05 | 0.18 | |
| X | .107 | .123 | 2.72 | 3.12 | |
| D | .337 | .344 | 8.56 | 8.74 | 20 AB |
| S | .0500 | .0550 | 1.270 | 1.397 | |
| D | .337 | .344 | 8.56 | 8.74 | 24 AC |
| S | .0250 | .0300 | 0.635 | 0.762 | |
| D | .386 | .393 | 9.80 | 9.98 | 28 AD |
| S | .0250 | .0300 | 0.635 | 0.762 | |
| X | .271 | .287 | 6.88 | 7.29 | |

NOTES:

1. D & E DO NOT INCLUDE MOLD FLASH OR PROTRUSIONS
2. MOLD FLASH OR PROTRUSIONS NOT TO EXCEED .006" PER SIDE.
3. HEAT SLUG DIMENSIONS X AND Y APPLY ONLY TO 16 AND 28 LEAD POWER-QSOP PACKAGES.
4. CONTROLLING DIMENSIONS: INCHES.

MAXIM
 PROPRIETARY INFORMATION
 TITLE:
 PACKAGE OUTLINE, QSOP, .150", .025" LEAD PITCH
 APPROVAL: _____ DOCUMENT CONTROL NO. 21-0055 REV. B 1/1

Low-Noise, 14V Input, 1A, PWM Step-Down Converters

NOTES

MAX1684/MAX1685

*Low-Noise, 14V Input, 1A, PWM
Step-Down Converters*

NOTES

MAX1684/MAX1685

Copyright © Each Manufacturing Company.

All Datasheets cannot be modified without permission.

This datasheet has been download from :

www.AllDataSheet.com

100% Free DataSheet Search Site.

Free Download.

No Register.

Fast Search System.

www.AllDataSheet.com