



Triple-Channel Video Reconstruction Filter and Buffer for Composite and Y/C Outputs

General Description

The MAX7443/MAX7444 are low-cost, triple-channel video reconstruction filters for S-video and CVBS video signals. These devices are ideal for anti-aliasing and DAC smoothing video applications such as set-top boxes, DVD players, hard-disk recorders (HDRs), and personal video recorders. These filters operate from a single +5V supply. They are optimized for NTSC, PAL, and standard-definition digital TV (SDTV) video systems.

Each channel consists of a lowpass filter and an adjustable-gain output buffer capable of driving two standard 150Ω video loads. The output buffers can drive either an AC or a DC load such that the blanking level voltage after the backmatch resistor is less than 1V. The Y and C video inputs are summed to produce the composite video output. The MAX7444 offers high-frequency boost to improve picture sharpness. The MAX7443 has a maximum flat-frequency response.

The MAX7443/MAX7444 are available in a tiny 8-pin thin QFN and an 8-pin SO package with exposed pad, and are fully specified over the -40°C to +85°C extended temperature range.

Applications

Set-Top Boxes/HDR/DVD	Digital VCRs
Security Cameras/Digital Cameras	Every Composite, S-Video Output for NTSC, PAL, SDTV
Game Consoles	

Features

- ◆ Triple-Channel Filter and Buffer for CVBS and Y/C (S-Video)
- ◆ Filter Response Ideal for NTSC, PAL, and Interlaced SDTV Signals
- ◆ 41dB (typ) Stopband Attenuation at 27MHz
- ◆ -0.3dB (typ) Passband Response
- ◆ Low Blanking Level Voltage Allows DC-Coupled Output
- ◆ Each Channel Drives Two 150Ω Video Loads
- ◆ +5V Single-Supply Voltage
- ◆ Tiny 8-Pin Thin QFN or 8-Pin SO Packages

Ordering Information

PART	TEMP RANGE	PIN-PACKAGE	TOP MARK
MAX7443ETA	-40°C to +85°C	8 Thin QFN-EP*	AFX
MAX7443ESA	-40°C to +85°C	8 SO-EP*	—
MAX7444ETA	-40°C to +85°C	8 Thin QFN-EP*	AFY
MAX7444ESA	-40°C to +85°C	8 SO-EP*	—

*EP = Exposed pad.

Selector Guide appears at end of data sheet.

Functional Diagram

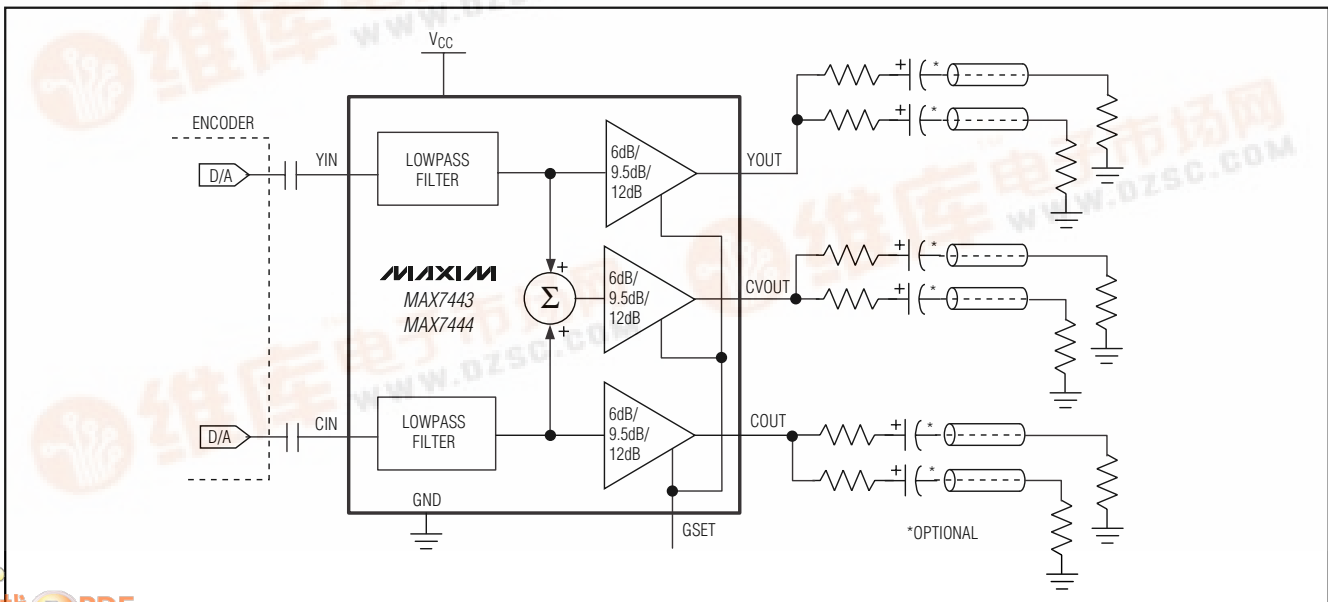

MAX7443/MAX7444



Triple-Channel Video Reconstruction Filter and Buffer for Composite and Y/C Outputs

ABSOLUTE MAXIMUM RATINGS

V_{CC} to GND+6V
 All Other Pins to GND.....-0.3V to (V_{CC} + 0.3V)
 Maximum Current into Any Pin Except V_{CC} and GND±50mA
 Continuous Power Dissipation (T_A = +70°C)
 8-Pin Thin QFN (derate 24.4mW/°C above +70°C) ...1951mW
 8-Pin SO (derate 18.9mW/°C above +70°C)..... 1509mW

Operating Temperature Range-40°C to +85°C
 Storage Temperature Range-65°C to +150°C
 Junction Temperature+150°C
 Lead Temperature (soldering, 10s)+300°C

Stresses beyond those listed under "Absolute Maximum Ratings" may cause permanent damage to the device. These are stress ratings only, and functional operation of the device at these or any other conditions beyond those indicated in the operational sections of the specifications is not implied. Exposure to absolute maximum rating conditions for extended periods may affect device reliability.

ELECTRICAL CHARACTERISTICS

(V_{CC} = +5V ±5%, C_L = 0 to 20pF, R_L = 75Ω to GND for DC-couple, R_L = 75Ω to V_{CC}/2 for AC-couple, C_{YIN} = C_{CIN} = 0.1μF, T_A = T_{MIN} to T_{MAX}, GSET = GND (6dB) and V_{CC} (9.5dB), unless otherwise noted. Typical values are at T_A = +25°C.)

PARAMETER	SYMBOL	CONDITIONS		MIN	TYP	MAX	UNITS
Passband Response		f = 100kHz to 4.2MHz, relative to 100kHz	MAX7443	-0.8	-0.3	+0.1	dB
			MAX7444	-0.1	+0.6	+0.92	
Stopband Attenuation	A _{SB}	f = 27MHz		39	41		dB
Boost Amplitude		f = 4.2MHz, MAX7444			0.6		dB
Differential Gain	dG	5-step modulated staircase	Gain = 6dB, 9.5dB, 12dB		0.15	0.4	%
Differential Phase	dθ	5-step modulated staircase	Gain = 6dB, 9.5dB, 12dB		0.15	0.4	Degrees
Signal-to-Noise Ratio	SNR	Peak signal (2V _{P-P}) to RMS noise, f = 100Hz to 50MHz	Gain = 6dB, 9.5dB, 12dB	67	73		dB
Group Delay Deviation	Δt _g	Deviation from 100kHz to 4.1MHz	MAX7443		8	20	ns
			MAX7444		12	30	
Line-Time Distortion	H _{DIST}	18μs, 100 IRE bar				0.3	%
Field-Time Distortion	V _{DIST}	130 lines, 18μs, 100 IRE bar				0.5	%
Clamp Settling Time		To ±1%				100	Lines
Output DC Clamp Level		YOUT		0.6	0.8	1.0	V
		CVOUT		0.6	0.8	1.0	
		COUT		1.44	1.6	1.97	
Low-Frequency Gain Accuracy	A _V	f = 100kHz, relative to 6dB		-3.5		+2	%
Group Delay Matching	t _g (MATCH)	Low-frequency channel-to-channel matching, f = 100kHz for YOUT and COUT			2		ns
Channel-to-Channel Crosstalk	X _{TALK}	f = 100kHz to 3.58MHz, gain = 6dB			61		dB
Input Leakage Current	I _{IN}					10	μA

Triple-Channel Video Reconstruction Filter and Buffer for Composite and Y/C Outputs

ELECTRICAL CHARACTERISTICS (continued)

($V_{CC} = +5V \pm 5\%$, $C_L = 0$ to $20pF$, $R_L = 75\Omega$ to GND for DC-couple, $R_L = 75\Omega$ to $V_{CC}/2$ for AC-couple, $C_{YIN} = C_{CIN} = 0.1\mu F$, $T_A = T_{MIN}$ to T_{MAX} , GSET = GND (6dB) and V_{CC} (9.5dB), unless otherwise noted. Typical values are at $T_A = +25^\circ C$.)

PARAMETER	SYMBOL	CONDITIONS	MIN	TYP	MAX	UNITS
Input Dynamic Swing	Y_{INP-P}	GSET = GND (6dB)			1.2	V_{P-P}
	C_{INP-P}	GSET = GND (6dB)			0.9	
SUPPLY						
Supply Voltage Range	V_{CC}		4.75		5.25	V
Supply Current	I_{CC}	$V_{CC} = +5.25V$, no load		88	110	mA
Power-Supply Rejection Ratio	PSRR	$V_{IN} = 100mV_{P-P}$, $f = 0$ to $3.5MHz$		33		dB

Typical Operating Characteristics

($V_{CC} = +5V$, $T_A = +25^\circ C$, unless otherwise noted.)

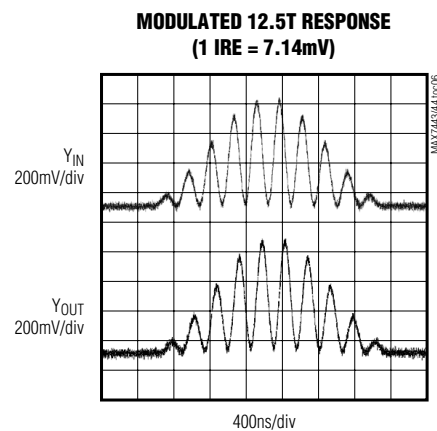
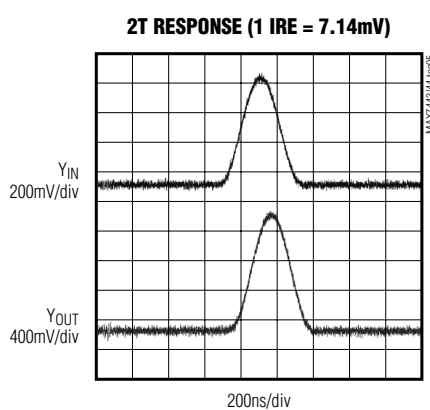
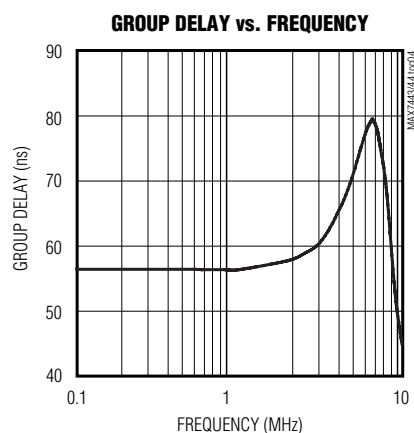
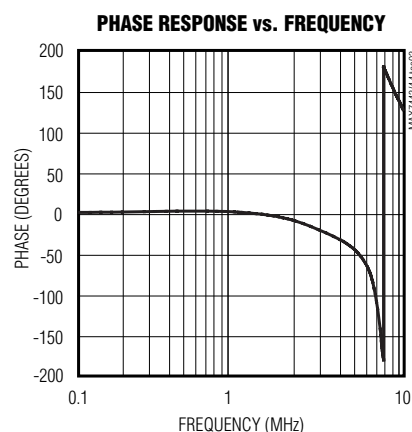
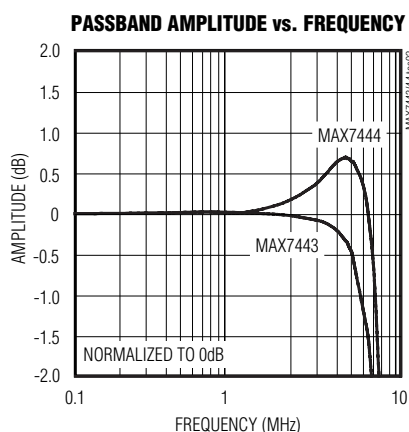
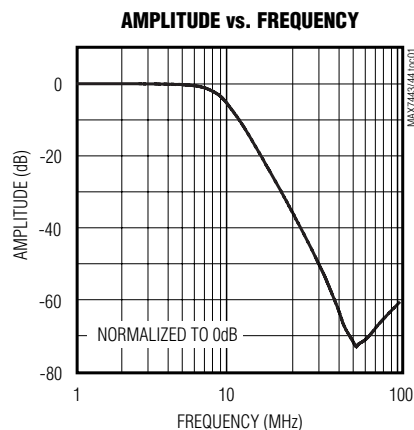

Triple-Channel Video Reconstruction Filter and Buffer for Composite and Y/C Outputs

Typical Operating Characteristics (continued)

($V_{CC} = +5V$, $T_A = +25^{\circ}C$, unless otherwise noted.)

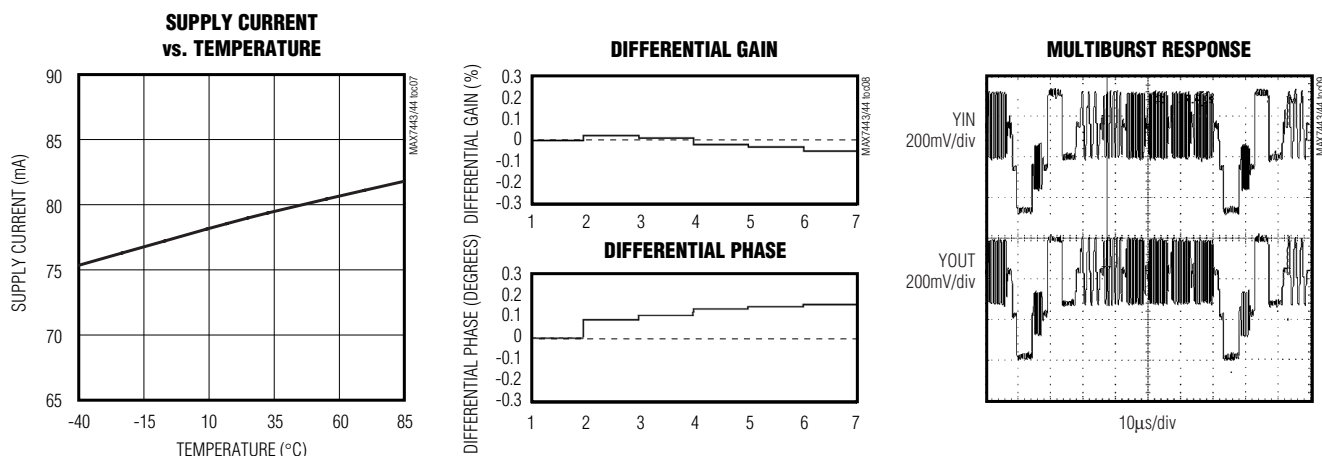

Pin Description

PIN	NAME	FUNCTION
1	YIN	Luma (Y) Input
2	GSET	Gain-Setting Control Input. See Table 1 for values.
3	CIN	Chroma (C) Input
4	GND	Ground
5	V_{CC}	5V Power Supply
6	COUT	Chroma (C) Output
7	CVOUT	Composite Video Output
8	YOUT	Luma (Y) Output

Detailed Description

The primary function of the MAX7443/MAX7444 is to filter and buffer the encoder DAC outputs that contain digital video information in applications such as set-top boxes, hard-disk recorders, DVD players, and digital VCRs. These devices reconstruct and clean up analog video signals. Each MAX7443/MAX7444 consists of a lowpass filter and an adjustable-gain output video buffer that is capable of driving two standard 150 Ω video loads. The luma (YIN) and chroma (CIN) video inputs are summed internally to provide the composite (CVOUT) video output.

These devices operate from a single +5V supply. The filters have a nominal cutoff frequency optimized for NTSC, PAL, and SDTV.

Filter

Filter Response

The reconstruction filter consists of two 2nd-order Sallen-Key stages. The Butterworth-type response features a maximally flat passband for NTSC and PAL bandwidths. The stopband offers 41dB (typ) of attenuation at sampling frequencies of 27MHz and above (see *Typical Operating Characteristics*).

High-Frequency Boost

The high-frequency boost available in the MAX7444 compensates for signal degradation and rolloff in the video encoder, which increases the image sharpness. The MAX7443 has a flat response over the video bandwidth.

Output Buffer

The output buffer drives two 150 Ω video loads with a 2V_{p-p} signal. The adjustable gain of the output buffer provides a gain of 6dB, 9.5dB, and 12dB, which are selected by tying the GSET pin to GND, V_{CC} , or floating, respectively. The MAX7443/MAX7444 can drive an AC load or drive the video load directly without using the large output capacitor. The output buffer drives a DC load with an output blanking level of less than 1V.

Triple-Channel Video Reconstruction Filter and Buffer for Composite and Y/C Outputs

Table 1. Gain-Setting Control

GSET	GAIN (dB)
GND	6
V _{CC}	9.5
Open	12

12dB Gain Setting

The GSET pin is biased internally to V_{CC}/2 through two 100kΩ resistors from V_{CC} to GND. The internal impedance at the node is 50kΩ. No additional connection is necessary since the pin offers a minimum noise margin immunity of 1V_{p-p}.

Output Clamp Level

When sync pulses in the luma signal (Y) are detected, the DC restore loop is activated. The function of the loop is to set the sync tip of the video signal to the desired DC level of 0.8V for YOUT and COUT and the average DC voltage of COUT at 1.6V.

Applications Information

Input Considerations

Use a 0.1μF ceramic capacitor to AC-couple the input to the MAX7443/MAX7444. This input capacitor stores a DC level such that the outputs are clamped to the appropriate DC voltage level.

Output Considerations

The outputs of the MAX7443/MAX7444 are typically connected to a 75Ω series back-match resistor followed by the video cable. Because of the inherent divide by two of this configuration, the blanking level of the video cable is always less than 1V, which complies with industry-standard video requirements. The video buffer can also drive an AC-coupled video load. Good video performance is achieved with an output capacitor as low as 220μF.

Power-Supply Bypassing and Layout

The MAX7443/MAX7444 operate from a single +5V supply. Bypass V_{CC} to GND with a 0.1μF capacitor. Place all external components as close to the device as possible. Refer to the MAX7443 evaluation kit for a proven PC board layout example.

Exposed Pads

Both the SO and thin QFN packages of the MAX7443/MAX7444 have exposed pads on the bottom of the packages. These pads are electrically connected to GND and should be connected to the ground plane for improved thermal conductivity. Do not route signals under these packages.

Selector Guide

PART	HIGH-FREQUENCY BOOST
MAX7443ETA	No
MAX7443ESA	No
MAX7444ETA	Yes
MAX7444ESA	Yes

Pin Configurations

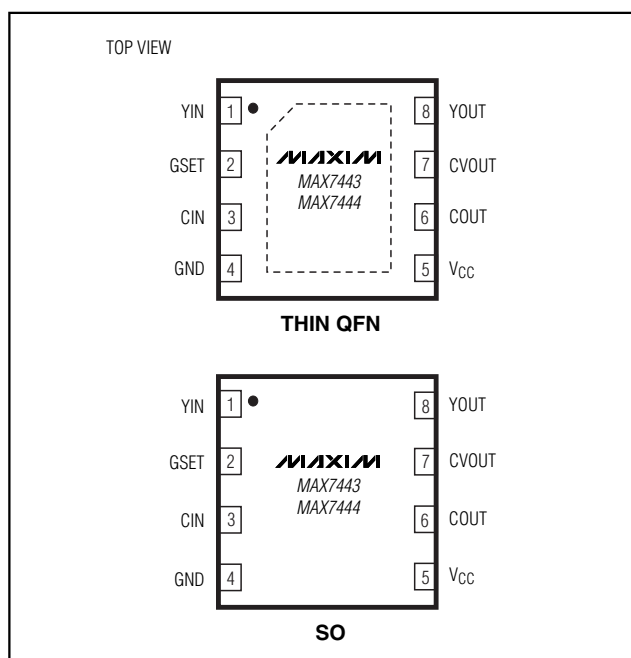

Chip Information

TRANSISTOR COUNT: 4252
PROCESS: BiCMOS

Triple-Channel Video Reconstruction Filter and Buffer for Composite and Y/C Outputs

Package Information

(The package drawing(s) in this data sheet may not reflect the most current specifications. For the latest package outline information, go to www.maxim-ic.com/packages.)

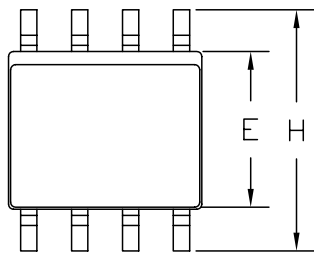

TOP VIEW

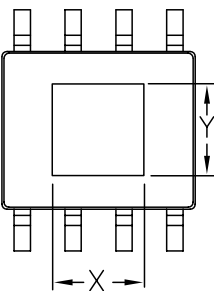

BOTTOM VIEW

DIM	INCHES		MILLIMETERS	
	MIN	MAX	MIN	MAX
A	0.053	0.069	1.35	1.75
A1	0.004	0.010	0.10	0.25
B	0.014	0.019	0.35	0.49
C	0.007	0.010	0.19	0.25
D	0.189	0.197	4.80	5.00
e	0.050	BSC	1.27	BSC
E	0.150	0.157	3.80	4.00
H	0.228	0.244	5.80	6.20
h	0.010	0.020	0.25	0.50
L	0.016	0.050	0.40	1.27
α	0°	8°	0°	8°
X	.082	.098	2.08	2.49
Y	.082	.098	2.08	2.49

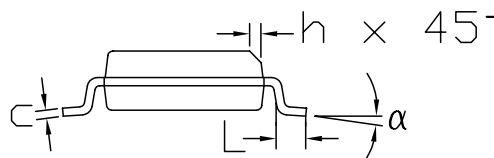
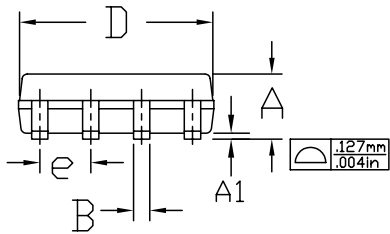

- NOTES:
1. D&E DO NOT INCLUDE MOLD FLASH.
 2. MOLD FLASH OR PROTRUSIONS NOT TO EXCEED .15mm (.006")
 3. CONTROLLING DIMENSION: MILLIMETER
 4. MEETS JEDEC MS-012 AA.
 5. DIMENSIONS X AND Y DEFINE EXPOSED PAD METAL AREA.



PROPRIETARY INFORMATION

TITLE PACKAGE OUTLINE
8L SOIC, .150" EXPOSED PAD

APPROVAL	DWG	REV	1/1
	21-0111	A	

8L SOIC EXP. PAD.EPS

Triple-Channel Video Reconstruction Filter and Buffer for Composite and Y/C Outputs

Package Information (continued)

(The package drawing(s) in this data sheet may not reflect the most current specifications. For the latest package outline information, go to www.maxim-ic.com/packages.)

MAX7443/MAX7444

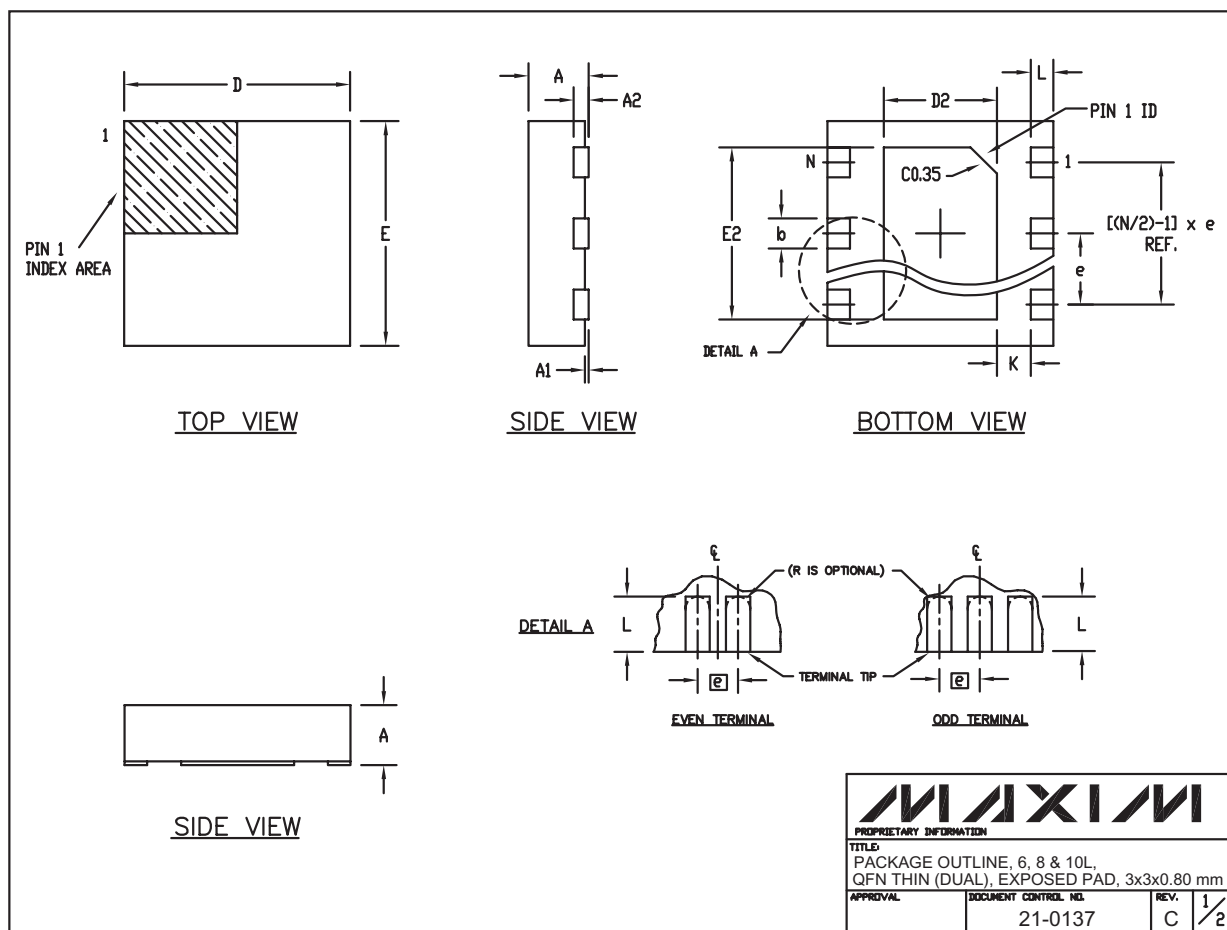

6, 8, & 10L, QFN THIN.EPS

MAXIM			
<small>PROPRIETARY INFORMATION</small>			
<small>TITLE</small>			
PACKAGE OUTLINE, 6, 8 & 10L, QFN THIN (DUAL), EXPOSED PAD, 3x3x0.80 mm			
<small>APPROVAL</small>	<small>DOCUMENT CONTROL NO.</small>	<small>REV.</small>	<small>1/2</small>
	21-0137	C	

Triple-Channel Video Reconstruction Filter and Buffer for Composite and Y/C Outputs

Package Information (continued)

(The package drawing(s) in this data sheet may not reflect the most current specifications. For the latest package outline information, go to www.maxim-ic.com/packages.)

COMMON DIMENSIONS		
SYMBOL	MIN.	MAX.
A	0.70	0.80
D	2.90	3.10
E	2.90	3.10
A1	0.00	0.05
L	0.20	0.40
k	0.25 MIN	
A2	0.20 REF.	

PACKAGE VARIATIONS							
PKG. CODE	N	D2	E2	e	JEDEC SPEC	b	[(N/2)-1] x e
T633-1	6	1.50-0.10	2.30-0.10	0.95 BSC	MO229 / WEEA	0.40-0.05	1.90 REF
T833-1	8	1.50-0.10	2.30-0.10	0.65 BSC	MO229 / WEEC	0.30-0.05	1.95 REF
T1033-1	10	1.50-0.10	2.30-0.10	0.50 BSC	MO229 / WEED-3	0.25-0.05	2.00 REF

NOTES:

1. ALL DIMENSIONS ARE IN mm. ANGLES IN DEGREES.
2. COPLANARITY SHALL NOT EXCEED 0.08 mm.
3. WARPAGE SHALL NOT EXCEED 0.10 mm.
4. PACKAGE LENGTH/PACKAGE WIDTH ARE CONSIDERED AS SPECIAL CHARACTERISTIC(S).
5. DRAWING CONFORMS TO JEDEC MO220.

			
<small>PROPRIETARY INFORMATION</small>			
<small>TITLE:</small> PACKAGE OUTLINE, 6, 8 & 10L, QFN THIN (DUAL), EXPOSED PAD, 3x3x0.80 mm			
<small>APPROVAL</small>	<small>DOCUMENT CONTROL NO.</small> 21-0137	<small>REV.</small> C	<small>REV.</small> 2/2

Maxim cannot assume responsibility for use of any circuitry other than circuitry entirely embodied in a Maxim product. No circuit patent licenses are implied. Maxim reserves the right to change the circuitry and specifications without notice at any time.

8 **Maxim Integrated Products, 120 San Gabriel Drive, Sunnyvale, CA 94086 408-737-7600**