

SONY

CXA1855Q/S

I²C Bus-Compatible Audio/Video Switch

Description

The CXA1855Q/S is a 5-input, 3-output audio/video switch featuring I²C bus compatibility for TVs.

Features

- Serial control with I²C bus
- 5 inputs, 3 outputs
- 3 outputs can each be independently selected
- Separate control of video and audio switches
- 6dB gain amplifiers for video system
- Wideband video amplifier (20MHz, -3dB)
- Y/C mixer circuit
- Slave address can be changed (90H/92H)
- Audio muting from external pin
- High impedance maintained by I²C bus line (SDA, SCL) even when power is OFF
- Wide audio dynamic range (3Vrms typ.)

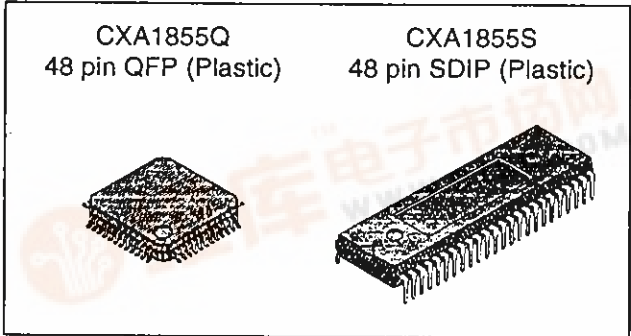

Absolute Maximum Ratings

• Supply voltage	Vcc	12	V
• Operating temperature	Topr	-20 to +75	°C
• Storage temperature	Tstg	-65 to +150	°C
• Allowable power dissipation	PD	750 (QFP) 1800 (SDIP)	mW

Operating Conditions

Supply voltage	Vcc	9±0.5	V
----------------	-----	-------	---

Applications

Audio/video switch featuring I²C bus compatibility for TVs

Structure

Bipolar silicon monolithic IC

Pin Configuration (Top View)

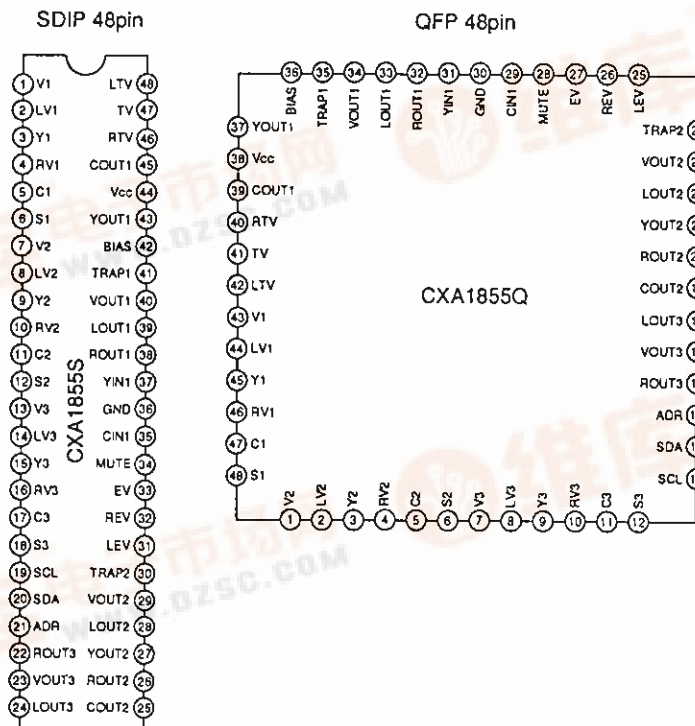

Sony reserves the right to change products and specifications without prior notice. This information does not convey any license by any implication or otherwise under any patents or other right. Application circuits shown, if any, are typical examples illustrating the operation of the devices. Sony cannot assume responsibility for any problems arising out of the use of these circuits.



Block Diagram

* Parenthesized numbers indicate Pin No. of CXA1855S.

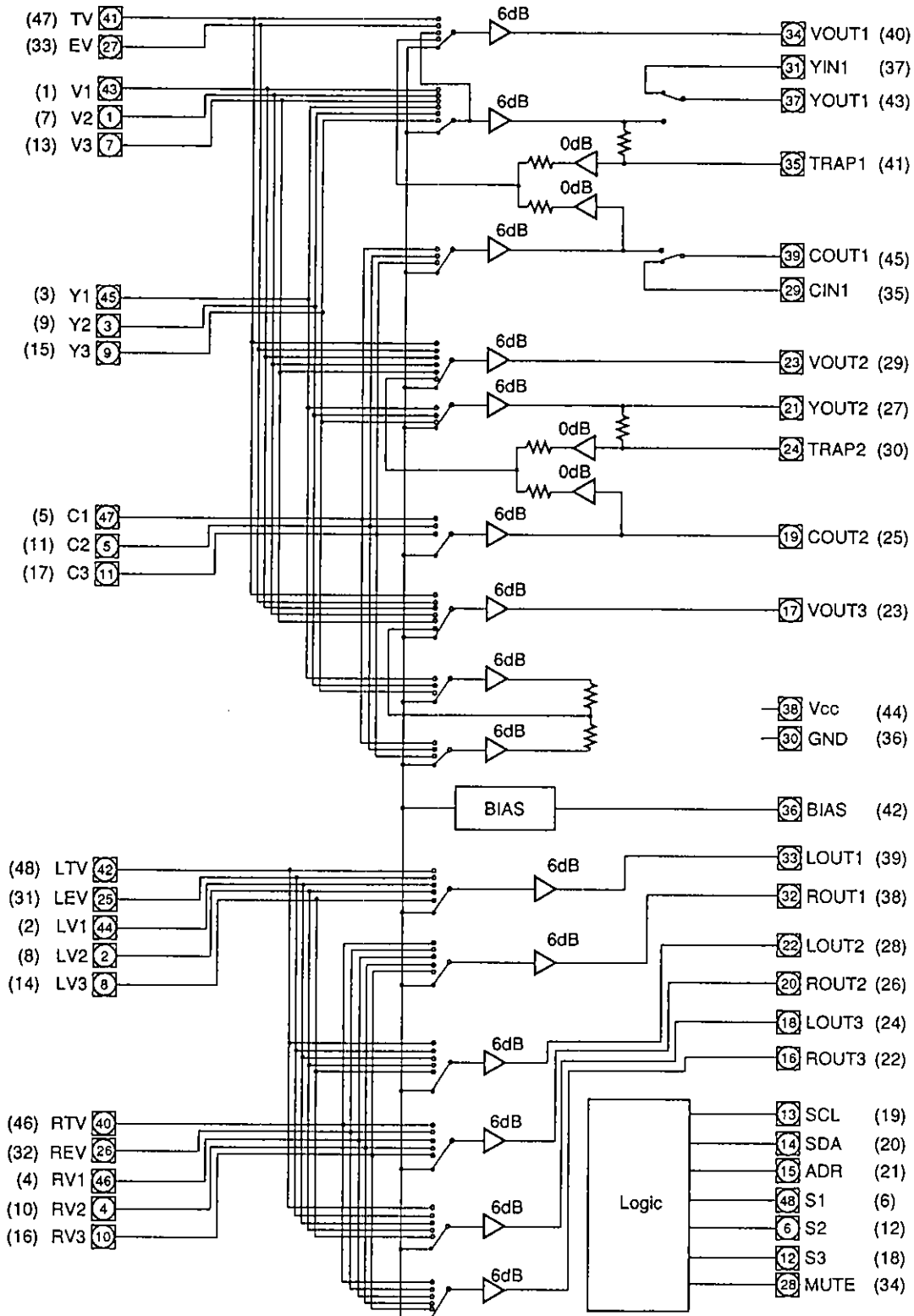

Note) A total gain of 0dB is achieved by connecting a 6kΩ resistor to the each audio input.

Pin Description

Parenthesized numbers indicate Pin No. of CXA1855S

Pin No.	Symbol	Pin voltage	Equivalent circuit	Description
41 (47) 27 (33) 43 (1) 1 (7) 7 (13)	TV EV V1 V2 V3	4.5V		Video signal inputs. Input composite video signals.
45 (3) 3 (9) 9 (15) 47 (5) 5 (11) 11 (17)	Y1 Y2 Y3 C1 C2 C3	4.5V		Y/C separation signal inputs Y1 to Y3 pins: Luminance signals input C1 to C3 pins: Chrominance signals input
42 (48) 25 (31) 44 (2) 2 (8) 8 (14) 40 (46) 26 (32) 46 (4) 4 (10) 10 (16)	LTV LEV LV1 LV2 LV3 RTV REV RV1 RV2 RV3	4.6V		Audio signal inputs.
34 (40) 23 (29) 17 (23)	VOUT1 VOUT2 VOUT3	4.5V		Video signal outputs. Output composite video signals.
37 (43) 21 (27) 39 (45) 19 (25)	YOUT1 YOUT2 COUT1 COUT2	4.5V		Y/C signal outputs. YOUT1, YOUT2 pins: Luminance signal output COUT1, COUT2 pins: Chrominance signal output

Pin No.	Symbol	Pin voltage	Equivalent circuit	Description
31 (37) 29 (35)	YIN1 CIN1	4.5V		Input the Y/C separated signal of VOUT1 output.
36 (42)	BIAS	4.5V		Internal reference bias ($V_{cc}/2$). A capacitor is connected between this pin and GND.
35 (41) 24 (30)	TRAP1 TRAP2	4.5V		Connect the subcarrier trap circuits.
33 (39) 22 (28) 18 (24) 32 (38) 20 (26) 16 (22)	LOUT1 LOUT2 LOUT3 ROUT1 ROUT2 ROUT3	4.6V		Audio signal outputs. $Z_{OUT}=50\Omega$ (Within DC $\pm 2mA$)
13 (19)	SCL	—		I ² C bus signal input. $V_{IL}=1.5V$ (max.) $V_{IH}=3.0V$ (min.)

Pin No.	Symbol	Pin voltage	Equivalent circuit	Description
14 (20)	SDA	—		<p>I²C bus signal input/output.</p> <p>V_{IL}= 1.5V (max.)</p> <p>V_{IH}= 3.0V (min.)</p> <p>V_{OL}=0.4V (max.)</p>
15 (21)	ADR	—		<p>Selects the slave address for the I²C bus.</p> <p>90H at 1.5V or less</p> <p>92H at 2.5V or more</p> <p>90H when open</p>
48 (6) 6 (12) 12 (18)	S1 S2 S3	—		<p>Video/S signal selection.</p> <p>S signal output at 0.8V or less</p> <p>Video signal output at 1.4V or more</p> <p>S signal output when open</p>
28 (34)	MUTE	—		<p>Audio output mute.</p> <p>Mute OFF at 1.5V or less</p> <p>Mute ON at 2.5V or more</p> <p>Mute OFF when open</p>

Electrical Characteristics

(Ta=25°C, Vcc=9V)

Item	Symbol	Conditions	Min.	Typ.	Max.	Unit
Current consumption	I _{CC}	V _{CC} =9V, no signal, no load	41	51	66	mA

(Video system)

Gain	GV _V	f=100kHz, 0.3V _{p-p} input (Fig. 1)	5.5	6.0	6.5	dB
Frequency response characteristics	FBW _{V1}	0.3V _{p-p} input, input frequency where output amplitude is -3dB with 100kHz output serving as 0dB (Fig. 1)	15	20	—	MHz
Frequency response characteristics (Y/C mix)	FBW _{V2}	0.3V _{p-p} input, input frequency where output amplitude is -3dB with 100kHz output serving as 0dB (Fig. 1)	10	15	—	MHz
Input dynamic range	V _{dv}	f=100kHz, maximum with distortion < 1.0% (Fig. 1)	2.0	—	—	V _{p-p}
Cross talk	V _{ctv}	f=4.43MHz, 1V _{p-p} input (Fig. 2)	—	—	-50	V _{p-p}

(Audio system)

Gain	GVA	f=1kHz, 1V _{p-p} input, 6kΩ resistor inserted to input (Fig. 3)	-1	0	1	dB
Frequency response characteristics	FBWA	1V _{p-p} input, input frequency where output amplitude is -3dB with 100kHz output serving as 0dB (Fig. 3)	50	—	—	kHz
Total harmonic distortion	THD	f=1kHz, 2.2V _{p-p} input, when 400Hz HPF+80kHz LPF are inserted (Fig. 3)	—	0.03	0.05	%
Input dynamic range	V _{dA}	f=1kHz, maximum with distortion < 0.3 % (Fig. 3)	2.8	3.0	—	V _{rms}
Cross talk	V _{ctA}	f=1kHz, 1V _{p-p} input (Fig. 4)	—	-90	-80	dB
Ripple rejection ratio		f=100Hz, 0.3V _{p-p} applied to V _{CC} (Fig. 5)	—	-55	-40	dB
Output DC offset	V _{OFF}	Offset voltage between input and output (Fig. 6)	-30	—	30	mV
Residual noise	V _{NA}	f _{CL} =300Hz, f _{CH} =19kHz, 40dB amplifier connected (Fig. 7)	0	—	6.0	mV
S/N ratio	S/N	f=1kHz, 1V _{rms} input (Fig. 3)	90	100	—	dB

(Logic system)

Item	Symbol	Conditions	Min.	Typ.	Max.	Unit
High level input voltage	V _{IH}		3.0	—	5.0	V
Low level input voltage	V _{IL}		0	—	1.5	V
Low level output voltage	V _{OL}	With SDA 3mA current supplied	0	—	0.4	V
High level input current	I _{IH}	V _{IH} =4.5V	0	—	10	μA
Low level input current	I _{IL}	V _{IL} =0.4V	0	—	10	μA
Maximum clock frequency	f _{SCL}		0	—	100	kHz
Minimum waiting time for data change	t _{BUF}		4.0	—	—	μs
Minimum waiting time for data transfer start	t _{HD; STA}		4.0	—	—	μs
Low level clock pulse width	t _{LOW}		4.7	—	—	μs
High level clock pulse width	t _{HIGH}		4.0	—	—	μs
Minimum waiting time for start preparation	t _{SU; STA}		4.7	—	—	μs
Minimum data hold time	t _{HD; DAT}		0	—	—	s
Minimum data preparation time	t _{SU; DAT}		250	—	—	ns
Rise time	t _R		—	—	1	μs
Fall time	t _F		—	—	300	ns
Minimum waiting time for stop preparation	t _{SU; STO}		4.7	—	—	μs

I²C Bus Control Signal

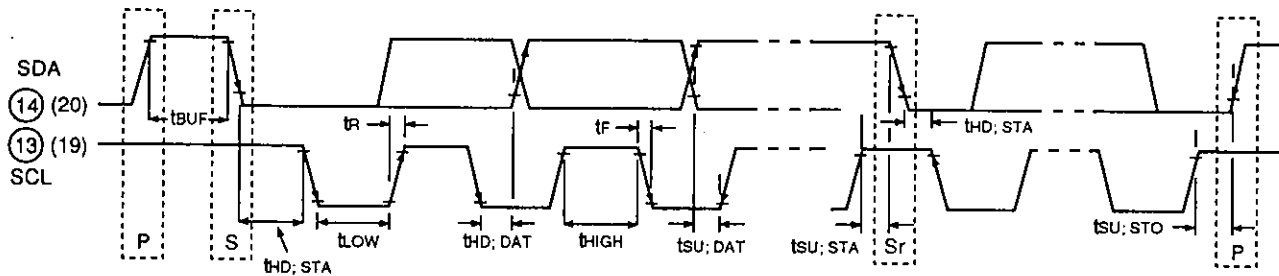

* Parenthesized numbers indicate Pin No. of CXA1855S.

Fig 7.

Description of Operation

The CXA1855Q/S is a TV I²C bus-compatible AV switch IC. The video system and the stereo audio system both have 5 inputs and 3 outputs each. Each video output is provided with a built-in 6dB amplifier. Desired inputs can be independently assigned to all outputs (in the audio system, the left and right channels are processed as one unit) by I²C bus control.

I²C Bus Registers

(1) I²C Bus

The I²C bus (Inter-IC bus) is an inter-IC bus system developed by Phillips.

Two wires (SDA-serial data, SCL-serial clock) provide control over start, stop, data transfer, synchronization, and collision avoidance. The IC outputs are either open collector or open drain, forming a bus line in the wired OR format.

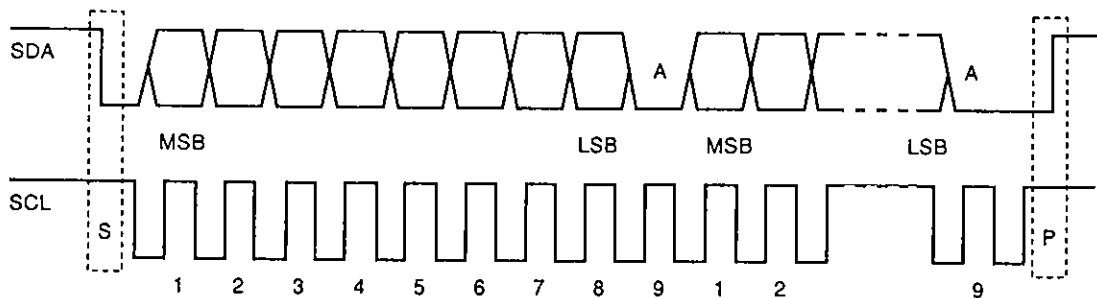

S: Start condition; SDA is set at "Low" when SCL is "High"
 P: Stop condition; SDA is set at "High" when SCL is "High"
 A: Acknowledge signal sent from the slave

Data is transmitted by MSB-first. One data unit consists of 8 bits, to which the acknowledge signal, which indicates that the data has been accepted by the slave, is attached at the end. Normally, the slave*1 IC receives data at the rising edge of SCL and the master*2 IC changes data at the falling edge of SCL.

*1 Slave: An IC that is placed under the control of the master. In a normal system, all devices excluding the central microcomputer are slaves.

*2 Master: A central microcomputer or other controlling IC.

(2) Control Registers

The CXA1855Q/S control is exercised by writing 3-byte data into the three 8-bit control registers which control the 3 outputs selector circuits.

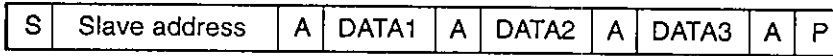

S: Start condition
 A: Acknowledge
 P: Stop condition

• **Slave address**

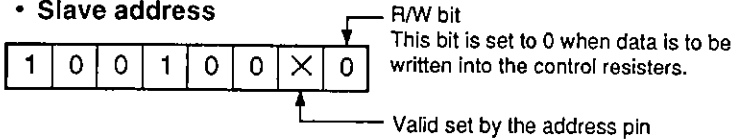

DATA1 Provides video 1 output control
 DATA2 Provides video 2 output control
 DATA3 Provides video 3 output control

• **Control register structure (DATA1 to DATA3)**

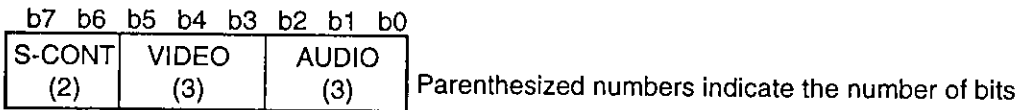

Each register is set to 0 upon power ON.

Video switch control (VIDEO)

b5	b4	b3	Input signal selected
0	0	0	Mute
0	0	1	TV
0	1	0	1V system
0	1	1	2V system
1	0	0	3V system
1	0	1	EV

1V system: V1, Y1, C1
 2V system: V2, Y2, C2
 3V system: V3, Y3, C3

Others-Mute

Audio switch control (AUDIO)

b2	b1	b0	Input signal selected
0	0	0	Mute
0	0	1	RTV/LTV
0	1	0	RV1/LV1
0	1	1	RV2/LV2
1	0	0	RV3/LV3
1	0	1	REV/LEV

Others-Mute

S input control (S CONT)

b7	b6	Output pin
1	0	Selects the composite input
1	1	Selects the S input

Composite input: TV, V1, V2, V3, EV
 S input: Y1, C1, Y2, C2, Y3, C3

Note) The YOUT1 and COUT1 switches are also switched by this control.

(3) Status Registers

S	Slave address	A	DATA	NA	P
---	---------------	---	------	----	---

- S: Start condition
- P: Stop condition
- A: Acknowledge

When communication is to be terminated in the status register reading mode, the "no acknowledge" signal is needed to assure that the master does not issue the acknowledge signal to slave.

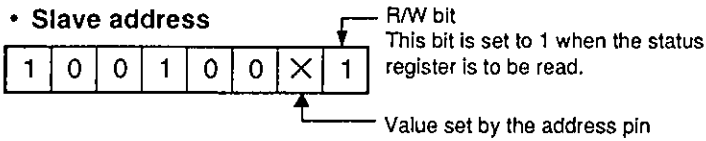

• **DATA**

b7	b6	b5	b4	b3	b2	b1	b0
PONRES	X	S1 OPEN	S1 SEL	S2 OPEN	S2 SEL	S3 OPEN	S3 SEL

PONRES

When the CXA1855Q/S is reset upon power ON, logical 1 is returned. Once a read operation is completed, logical 0 is returned.

S1 to S3 OPEN

- 0: S1 to S3 pins are not open.
- 1: S1 to S3 pins are open.

S1 to S3 SEL

- 0: S1 to S3 pins are not grounded.
- 1: S1 to S3 pins are grounded.

In actually, the logic states of the S1 to S3 OPEN and the S1 to S3 SEL bits are determined by comparing the DC voltages of S1 to S3 pins to two threshold values.

DC voltage of S1 to S3 pins	S1 to S3 OPEN	S1 to S3 SEL
0.8V or less	0	1
1.3V or more, 3.5V or less	0	0
4.5V or more	1	0

(4) Power ON reset

The CXA1855Q/S incorporates the power ON reset function. Therefore, each control register is reset to 0 upon power ON. The power ON reset V_{cc} and released V_{cc} are as shown below.

The power ON reset V_{TH} is hysteretical. The PONRES bit of the status register is read to determine whether the IC is reset upon power ON.

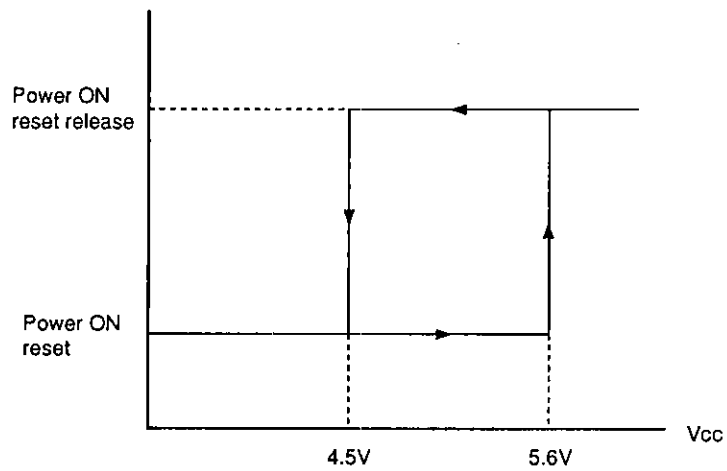

Example of Representative Characteristics

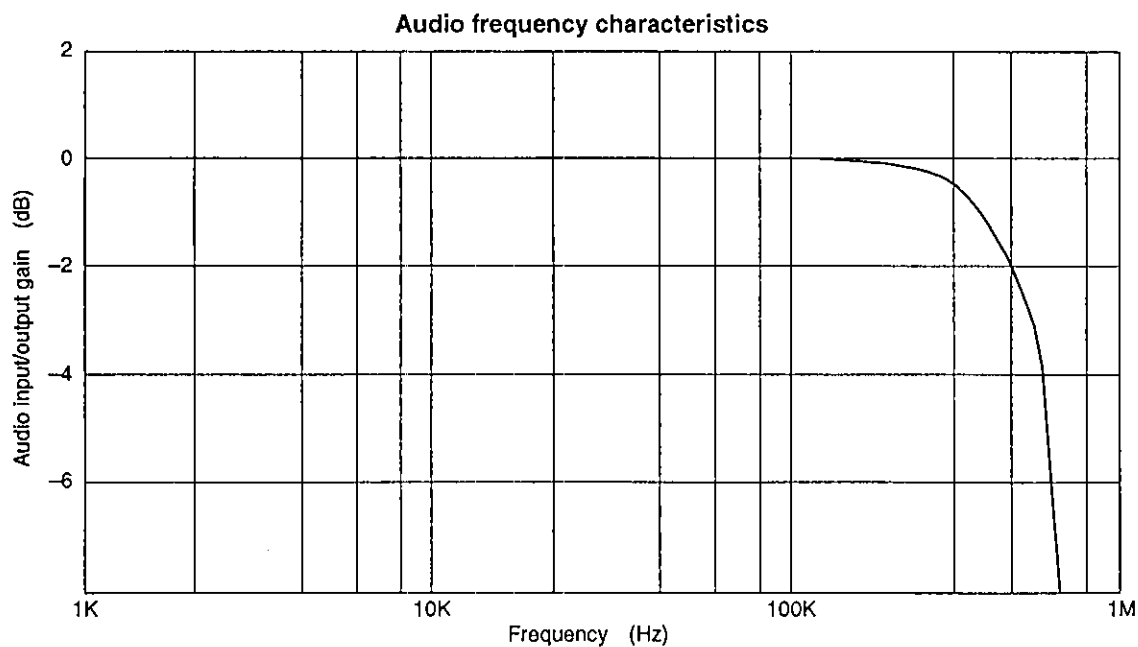
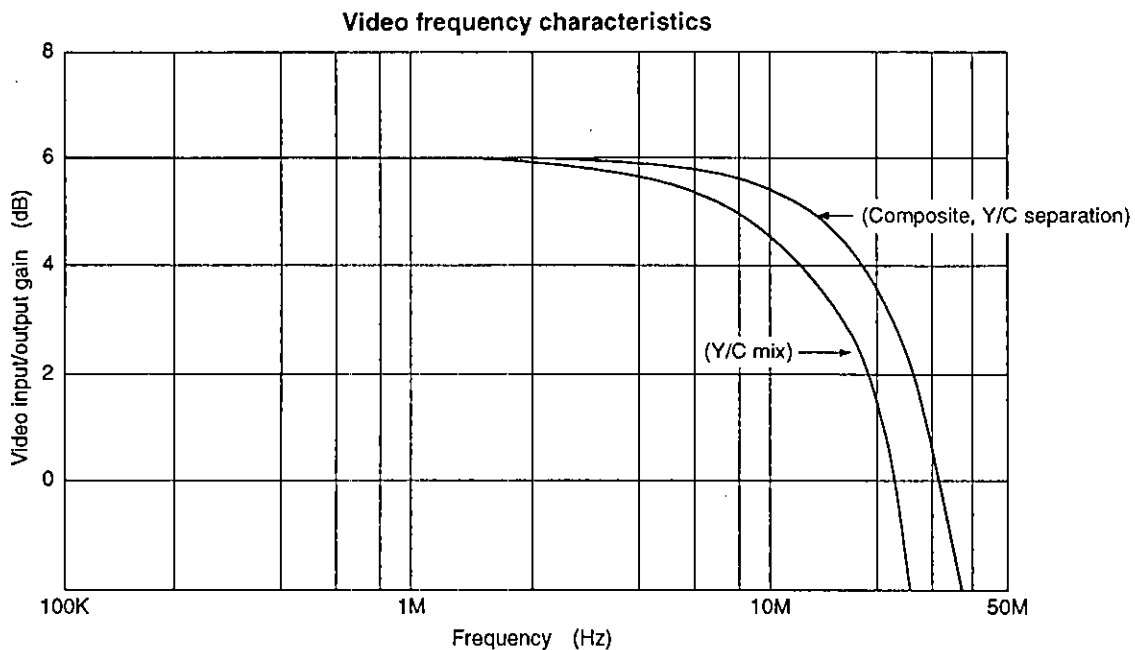

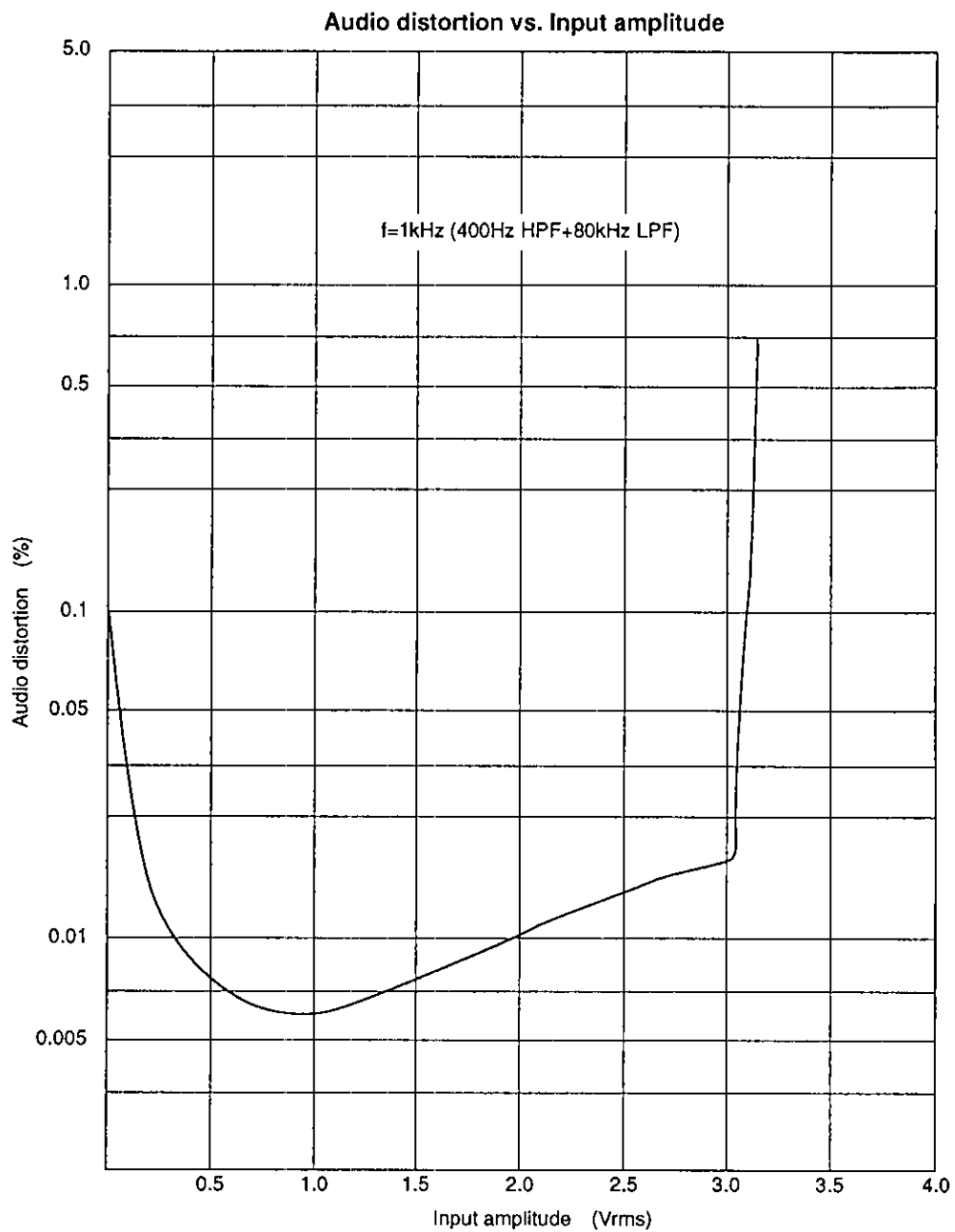

Package Outline

Unit : mm

CXA1855Q

48pin QFP (Plastic) 0.7g

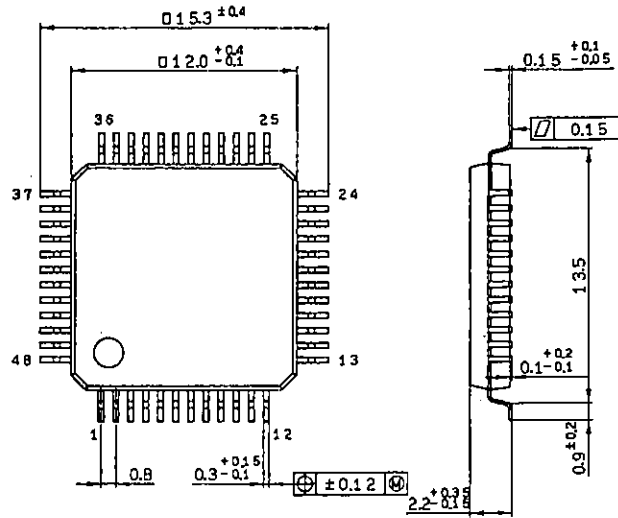

SONY NAME	QFP-48P-1.04
EIAJ NAME	QFP048-P-1212-B
JEDEC CODE	

CXA1855S

48pin SOIP (Plastic) 600mil 5.1g

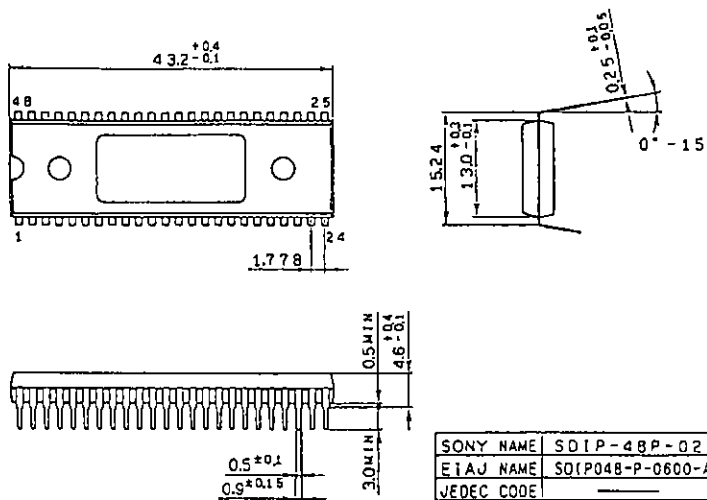

SONY NAME	SOIP-48P-02
EIAJ NAME	SOIP048-P-0600-A
JEDEC CODE	