

SONY

CXA2022S

I²C Bus Sound Processor for TV

Description

The CXA2022S is a bipolar IC designed as an I²C bus control sound processor for TV. This IC has simulate stereo, surround, tone control, balance, volume, muting, AGC and other functions.

Features

- Allows control by I²C bus
- Employs a special surround system to prevent "vocal missing" in the surround mode
- Adopts an AGC circuit to absorb the difference in sound level between input sources and improves S/N ratio of hearing characteristics

Absolute Maximum Ratings

- Supply voltage V_{cc} 14 V
- Operating temperature T_{opr} -20 to +75 °C
- Storage temperature T_{stg} -65 to +150 °C
- Allowable power dissipation P_d 1.25 W

Recommended Operating Condition

Supply voltage 8 to 13 V

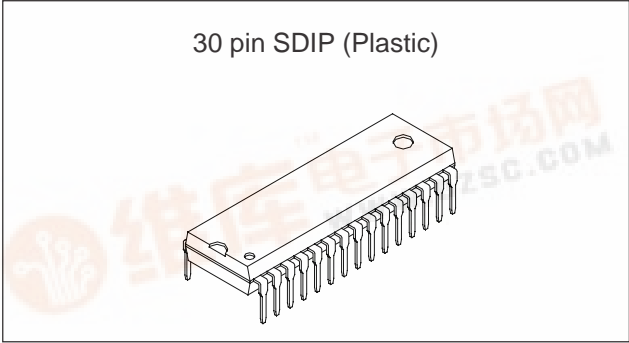

Structure

Bipolar silicon monolithic IC

Applications

TVs

Pin Configuration

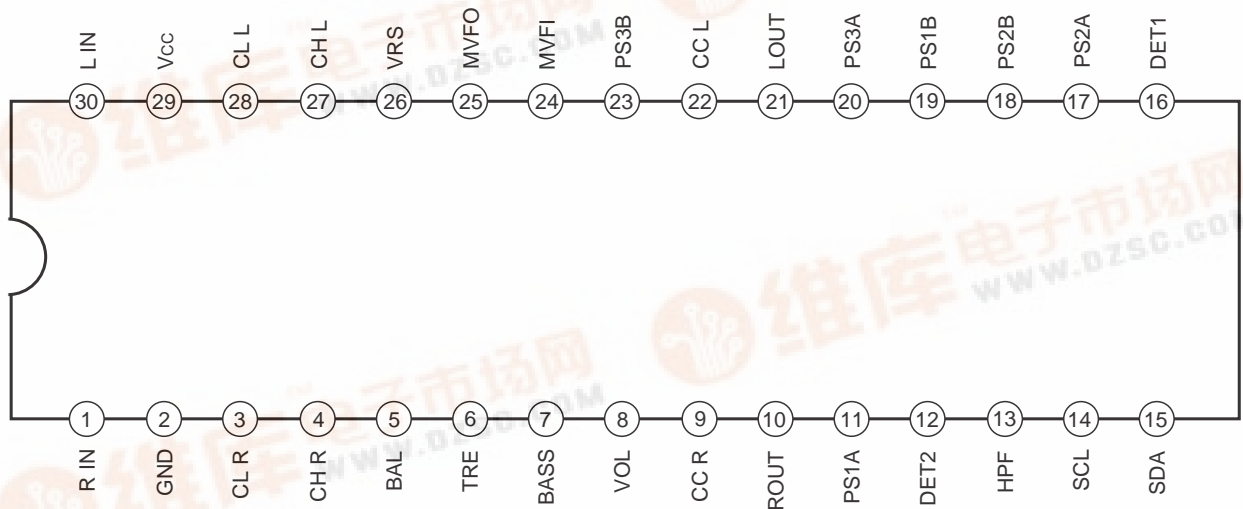

Block Diagram

Description of internal switches
 MS ... Monaural Surround
 (Simulate Stereo)
 SS ... Stereo Surround 1,2
 SS-1 ... Stereo Surround 1
 SS-2 ... Stereo Surround 2
 OFF ... Surround OFF

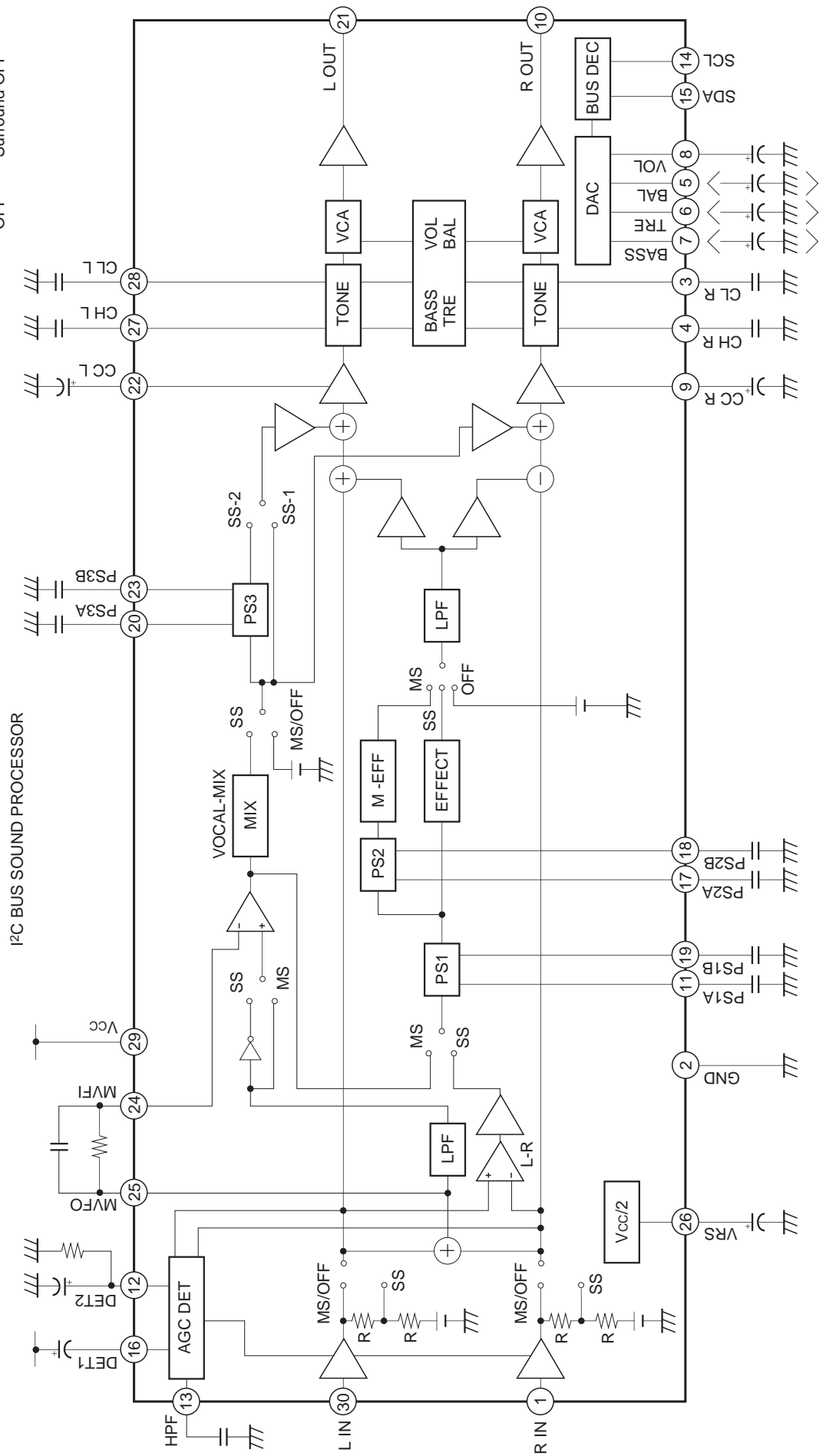

Pin Description

(Ta = 25°C, Vcc = 12V)

Pin No.	Symbol	Pin voltage	Equivalent circuit	Description
1 30	R IN L IN	6V		Input pins.
2	GND	0V		GND
3 28	CL R CL L	6V		External pins for LPF capacitance (BASS).
4 27	CH R CH L	6V		External pins for HPF capacitance (TREBLE).
5 6 7 8	BAL TRE BASS VOL	4.5V		DAC output pins. Connect LPF capacitance of DAC. Internal impedance is approximately 20kΩ.

Pin No.	Symbol	Pin voltage	Equivalent circuit	Description
9 22	CC R CC L	6V		DC-cut pins for L and R. Internal impedance is approximately 20kΩ.
10 21	ROUT LOUT	6V		Output pins.
11 17 18 19 20 23	PS1A PS2A PS2B PS1B PS3A PS3B	6V		External capacitance pins for surround phase-shifter. Internal impedance is approximately 18kΩ.
12	DET2			AGC detector output and control pin.

Pin No.	Symbol	Pin voltage	Equivalent circuit	Description
13	HPF	6V		HPF external capacitance pin of AGC.
14	SCL			I ² C bus clock line pin.
15	SDA			I ² C bus data line pin.
16	DET1	7.8V		AGC detector output pin. Connect capacitance for setting time constant.

Control Register Table (SLAVE ADDRESS = 82H)

DATA							
bit 7	bit 6	bit 5	bit 4	bit 3	bit 2	bit 1	bit 0
VOLUME (00)						MUTE (0)	AGC (0)
BASS (00)				*	MODE (00)		
TREBLE (00)				*			
BALANCE (00)					*		
SURR-EFFECT (00)				MONO-EFFECT (00)			
VOCAL-MIX (00)				*			

(Power ON setting value)

AGC : 0 = OFF/1 = ON
MUTE : 0 = OFF/1 = ON

MODE : 00 = Surround OFF
: 01 = Simulate Stereo
: 10 = Stereo Surround 1
: 11 = Stereo Surround 2

* Undefined

Description of Register

- VOLUME: Common to both L and R channels
0 = Minimum
3F = Maximum
- MUTE: MUTE switch
0 = Mute OFF
1 = Mute ON (muting state)
- AGC: AGC switch
0 = AGC OFF
1 = AGC ON
- BASS: Low frequency control
0 = Minimum
10 = Typical
1F = Maximum
- MODE: Surround mode setting
00 = Surround OFF
01 = Simulate Stereo (Monaural Surround)
10 = Stereo Surround 1
11 = Stereo Surround 2
- TREBLE: High frequency control
00 = Minimum
10 = Typical
1F = Maximum

- **BALANCE:** Balance control for L and R channels
 00 = L channel (Minimum), R channel (Maximum)
 20 = Typical
 3F = L channel (Maximum), R channel (Minimum)
- **SURR-EFFECT:** Effect setting for Stereo Surround 1 and 2
 0 = Minimum
 8 = Typical
 F = Maximum
- **MONO-EFFECT:** Effect setting for Simulate Stereo (Monaural Surround)
 0 = Minimum
 F = Maximum
- **VOCAL-MIX:** Addition amount setting of middle frequency for Stereo Surround 1 and 2
 0 = Minimum
 8 = Typical
 F = Maximum

Application Circuit

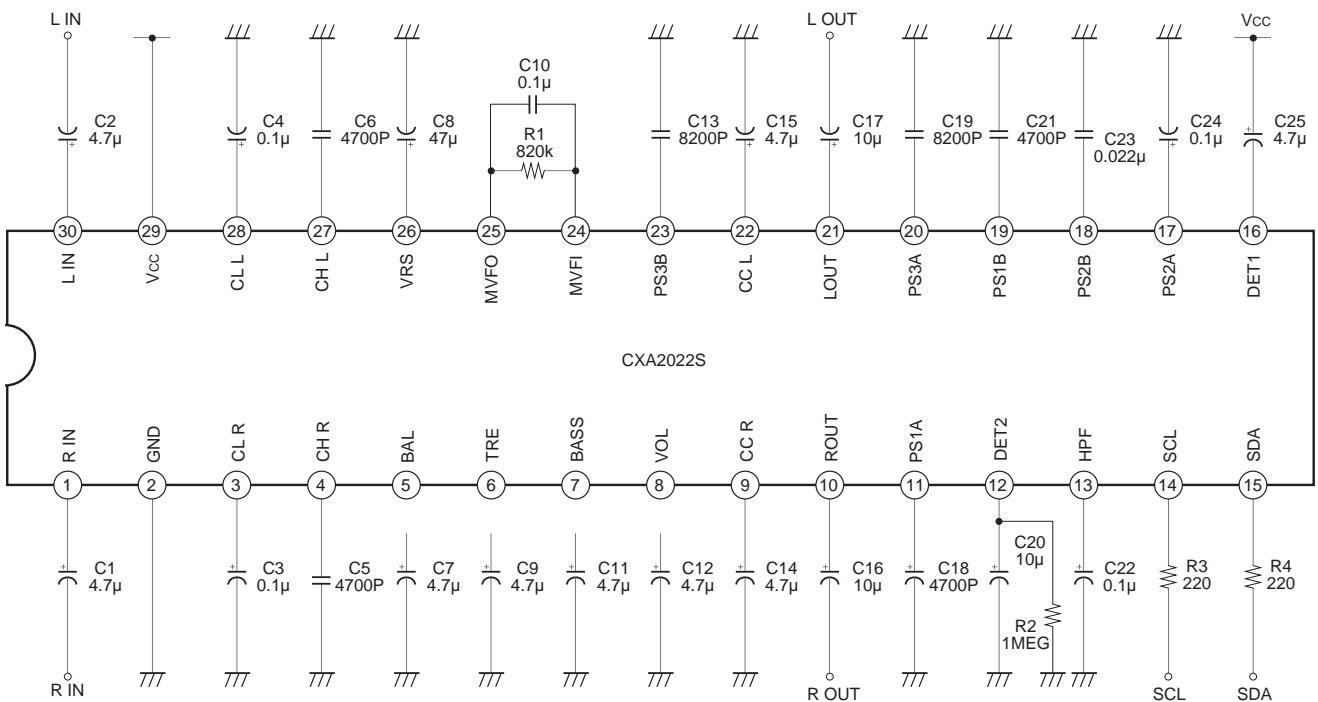

Application circuits shown are typical examples illustrating the operation of the devices. Sony cannot assume responsibility for any problems arising out of the use of these circuits or for any infringement of third party patent and other right due to same.

(Ta = 25°C, Vcc = 12V)

Electrical Characteristics

No.	Measurement item	Signal	Input conditions											Input point	Input signal	SW set to ON	Measurement point	Remarks	Min.	Typ.	Max.	Unit							
			VOL	MUTE	AGC	BASS	MODE	TRE	BAL	S-EFF	M-EFF	V-MIX																	
1	Current consumption	Icc	3F	0	0	10	0	0	10	20	8	8	8					20	35	55	mA								
2	FLAT L, R	VFL,R	→															L-IN R-IN	1kHz 2.4Vrms			REF: INPUT	-2.0	0	2.0	dB			
3	REF, Level L, R	VR,L,R	20																				-17	-14	-11	dB			
4	VOL MIN L, R	VMIN,L,R	0																				→	-	-	-70	dB		
5	FLAT f characteristics 100Hz	VFL,L,R	20																						0	0	1.5	dB	
6	FLAT f characteristics 10kHz	VHF,L,R				→																				0	0	1.5	dB
7	BASS BOOST 100Hz	VBSTLF			1F				1F																	11	11	13.5	dB
8	TREBLE BOOST 10kHz	VBSTHF			→				→																	11	11	13.5	dB
9	BASS CUT 100Hz	VCUTLF			0				0																	-11	-11	-8.5	dB
10	TREBLE CUT 10kHz	VCUTHF			→				→																	-11	-11	-8.5	dB
11	BALANCE BOOST L	VBALBSTL			10				10	3F																1.2	1.2	2.0	dB
12	BALANCE CUT L	VBALCUTL								0																-	-	-30	dB
13	BALANCE BOOST R	VBALBSTR								→																1.2	1.2	2.0	dB
14	BALANCE CUT R	VBALCUTR	→							3F																-	-	-30	dB
15	Distortion L, R	Vdist	3F							20																-	-	2.0	%

No.	Measurement item	Signal	Input conditions										Input point	Input signal	SW set to ON	Measurement point	Remarks	Min.	Typ.	Max.	Unit			
			VOL	MUTE	AGC	BASS	MODE	TRE	BAL	S-EFF	M-EFF	V-MIX												
16	Mute L, R	VMT L, R	3F	1	0	0	10	0	10	0	10	20	8	8	8	L-IN R-IN	1kHz 2.4Vrms		LOUT ROUT	REF: INPUT	—	—	-70	dB
17	Cross-Talk L → R	VCT L, R		0												L-IN			ROUT	REF: VFR	—	—	-70	dB
18	Cross-Talk R → L	VCTR, L														R-IN			LOUT	REF: VFL	—	—	-70	dB
19	NOISE LEVEL L, R	VNOI L, R																	LOUT ROUT		—	—	-60	dBm
20	AGC BOOST L, R	VGCBL, R			0											L-IN R-IN	1kHz 10mVrms			REF: AGC-OFF (0)	0.5	3	5.5	dB
21	AGC BOOST L, R	VGCBL2, R			0												1kHz 50mVrms			REF: AGC-OFF (0)	5	7	10	dB
22	AGC NULL L, R	VGCN L, R			0												1kHz 160mVrms			REF: AGC-OFF (0)	-2.5	-0.5	2	dB
23	AGC CUT L, R	VGCC L, R			0												1kHz 2Vrms			REF: AGC-OFF (0)	-24	-20	-16	dB
24	MONO FIL 100HZ	MFL L			0			1									100Hz 1.25Vrms	SW2	PS2B	REF: INPUT	-11	-8.5	-6	dB
25	MONO FIL 500HZ	MFL M															500Hz 1.25Vrms				-18	-15.5	-13	dB
26	MONO FIL 10kHz	MFL H															10kHz 1.25Vrms				-1.5	1.0	3.5	dB
27	MS MIX LEVEL L, R	MMX L, R												F		PS1A	1kHz 350mVrms	SW1	LOUT ROUT		13	16	19	dB
28	SS DIF GAIN L	SDG L						2						8		L-IN	1kHz 2.5Vrms	SW4	PS1B		-4	-2	0	dB
29	SS DIF GAIN R	SDG R						3								R-IN					-4	-2	0	dB
30	SS MIX LEVEL L	SMX L						2						F		PS1A	1kHz 350mVrms	SW1	LOUT		13	16	19	dB

No.	Measurement item	Signal	Input conditions										Input point	Input signal	SW set to ON	Measurement point	Remarks	Min.	Typ.	Max.	Unit	
			VOL	MUTE	AGC	BASS	MODE	TRE	BAL	S-EFF	M-EFF	V-MIX										
31	SS MIX LEVEL R	SMXR	3F	0	0	10	3	10	20	F	8	8	8	PS1A	1kHz 350mVrms	SW1	ROUT	REF: INPUT	13	16	19	dB
32	V-FIL 100HZ	VFILL					2			8				L-IN R-IN	100HZ 2.5Vrms	SW6	PS3B		-7.5	-5	-2.5	dB
33	V-FIL 1kHz	VFILM					3								1kHz 2.5Vrms				-3	-0.5	2	dB
34	V-FIL 10kHz	VFILH					2								10kHz 2.5Vrms				-10.5	-8	-5.5	dB
35	V-MIX L, R	VMXL, R												MVFI	1kHz 500mVrms	SW7	LOUT ROUT		10.5	13.5	16.5	dB
36	SS2-MIX	SS2MX					3							PS3A		SW5	LOUT		11	14	17	dB
37	DC OFF-Set OFF → MS-L, R	DOOM					0 1										LOUT ROUT	REF: MODE0	-150	0	150	mV
38	DC OFF-Set OFF → SS1-L, R	DOSS1L, R					0 2												-150	0	150	mV
39	DC OFF-Set OFF → SS2-L	DOSS2					0 3										LOUT		-150	0	150	mV
40	DC OFF-Set SS2 → MS-L, R	DOSS2M, L, R					3 1										LOUT ROUT	REF: MODE3	-150	0	150	mV
41	DC OFF-Set SS1 → MS-L	DOSS1M					2 1										LOUT	REF: MODE2	-150	0	150	mV
42	VOL MIN NOISE L, R	VMINNO L, R	0				0										LOUT ROUT	30kHz LPF	—	-92	-85	dBm

Description of Operation

- AGC circuit

The AGC circuit is provided at the input. When AGC is set to ON, this circuit is 0dB for small signal input, boosts for medium signal input, and achieves gain reduction for large signal input. The sound level difference between input sources can be absorbed at this circuit.

- Surround circuit

The surround circuit provides three modes; MONO (Simulate Stereo), STEREO-1 and STEREO-2.

MONO mode

L + R signals, passed through the mono filter and then through four stages of phase shifters (PS1A, PS1B, PS2A, PS2B) and 9kHz LPF, are added to L and R channels at opposite phase to each other.

The surround effect can be changed by the MONO-EFFECT.

STEREO-1 mode

L-R signals, passed through two stages of phase shifters (PS1A, PS1B) and 9kHz LPF, are added to L and R channels at opposite phase to each other. The surround effect can be changed by the SURR-EFFECT. In addition, L + R signals passed through the middle frequency BPF (1kHz BPF) are added to L and R channels at in-phase to each other to prevent "vocal missing" in the surround mode. The addition amount of middle frequency can be changed by the VOCAL-MIX.

STEREO-2 mode

L-R signals, passed through two stages of phase shifters (PS1A, PS1B) and 9kHz LPF, are added to L and R channels at opposite phase to each other. The surround effect can be changed by the SURR-EFFECT. In addition, L + R signals passed through the middle frequency BPF (1kHz BPF) are added to R channel, and the middle frequency signals passed further through two stages of phase shifters (PS3A, PS3B) are added to the L channel. The addition amount of middle frequency (L and R) can be changed by the VOCAL-MIX.

Phase Shifter

Each of the phase shifters PS1, PS2 and PS3 consists of two stages of phase shifters (A, B). The transfer function for a stage of phase shifter is expressed by the following equation.

$$V_o = \frac{1 - SCR}{1 + SCR} V_{in}$$

R: Internal resistance $\approx 18k\Omega$, C: External capacitance

- TONE circuit

Provides tone controls for BASS and TREBLE. The external capacitance of C_L for BASS and C_H for TREBLE can determine the characteristics. The number of steps is 32.

- BALANCE and VOLUME circuit

Provides controls for BALANCE and VOLUME. the number of steps is 64 each.

- DAC circuit

Provides controls for BASS, TREBLE, VOLUME and BALANCE. The internal impedance is approximately $20k\Omega$ and the LPF capacitance is used externally.

Example of Representative Characteristics

TONE characteristics

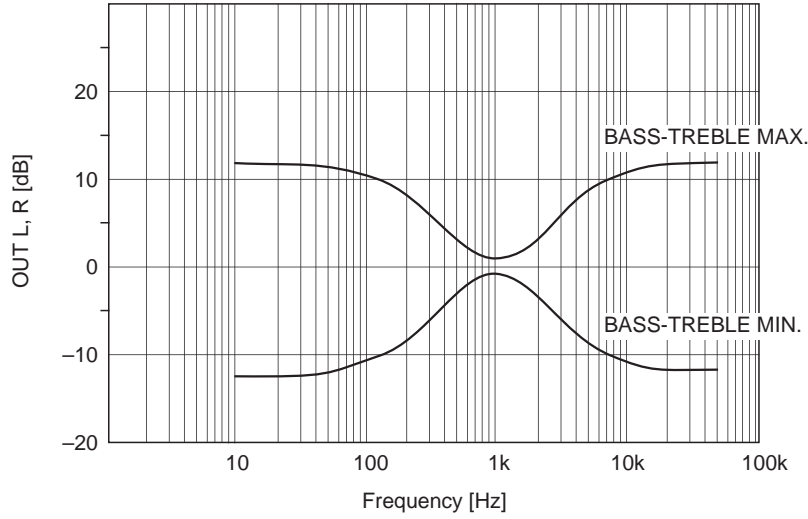

CH. vs. TREBLE-CONTROL (MAX)

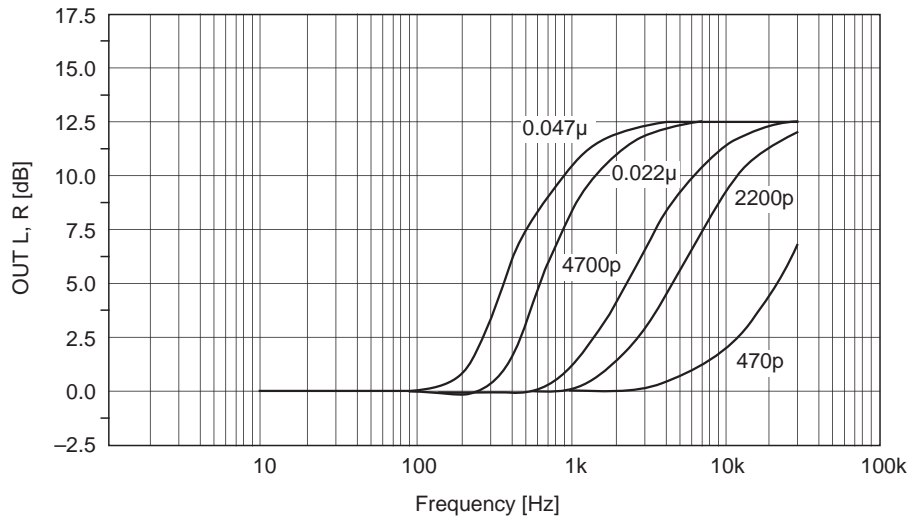

CH. vs. BASS-CONTROL (MAX)

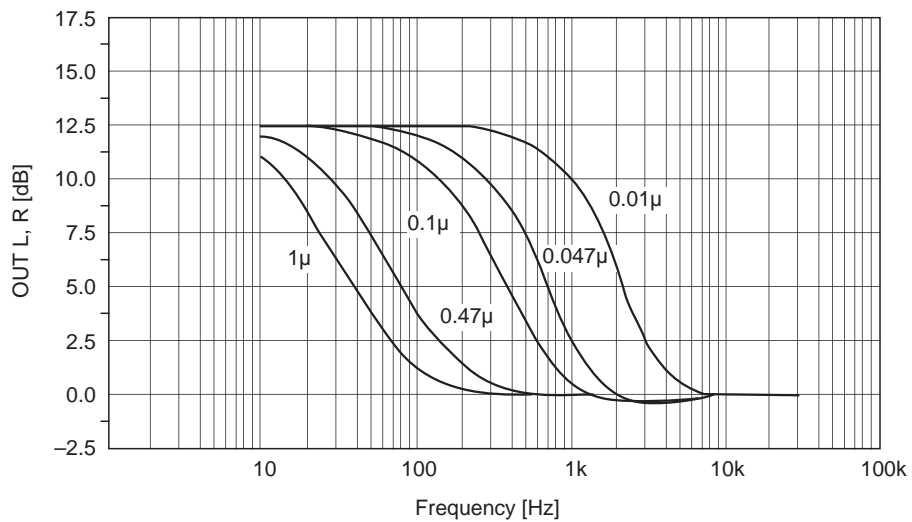

VOL CONTROL characteristics

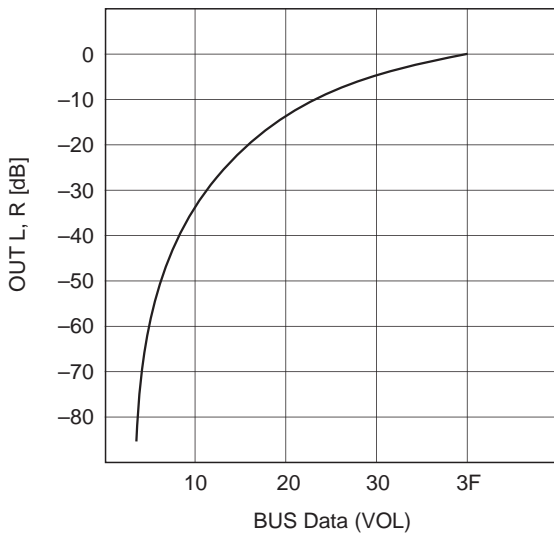

BALANCE CONTROL characteristics

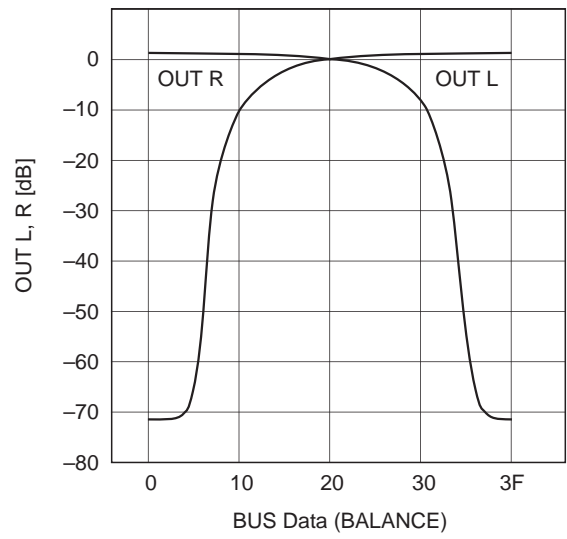

BASS CONTROL characteristics

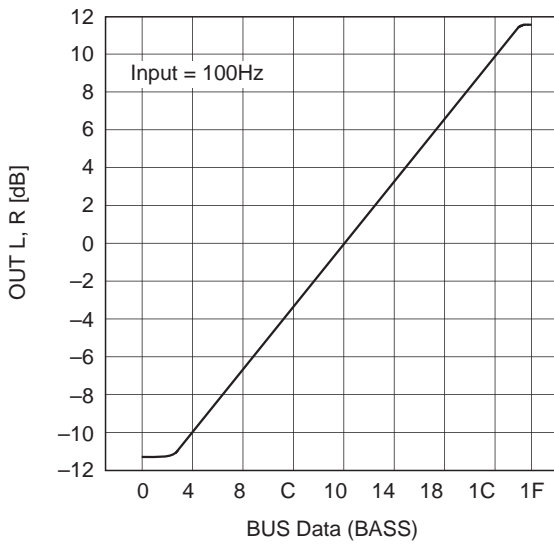

TREBLE CONTROL characteristics

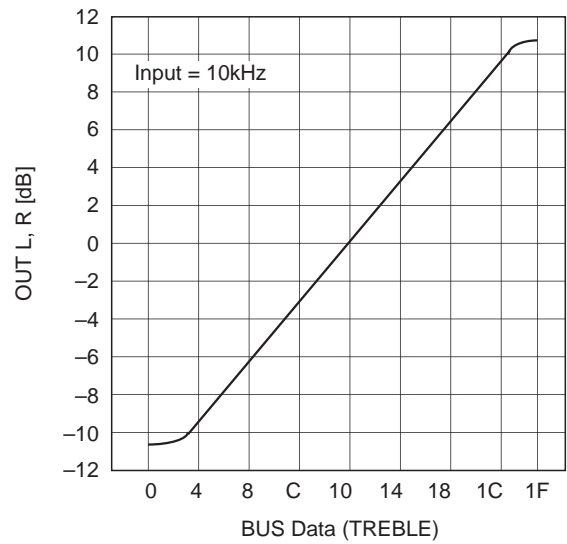

AGC characteristics

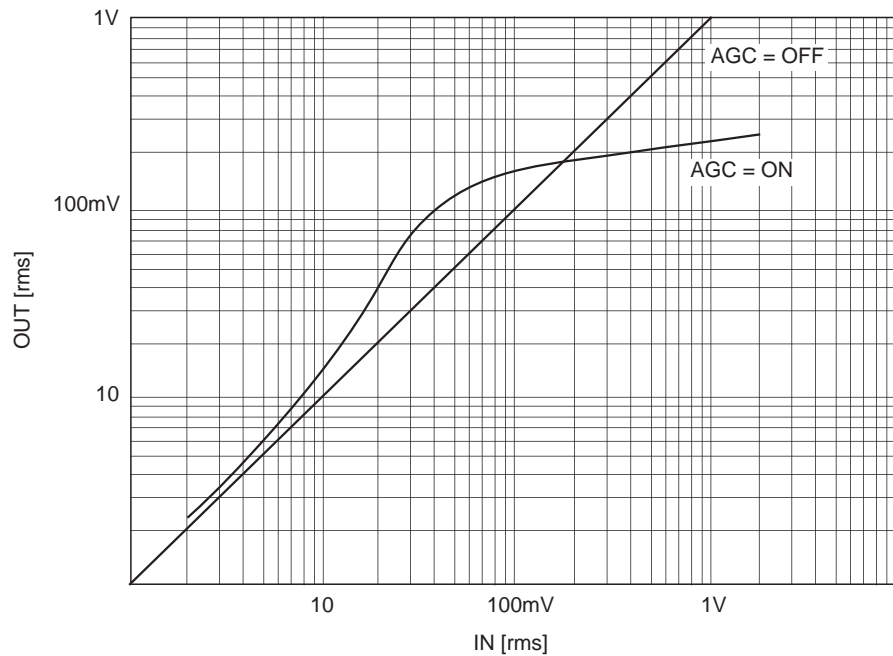

Package Outline Unit : mm

30PIN SDIP (PLASTIC)

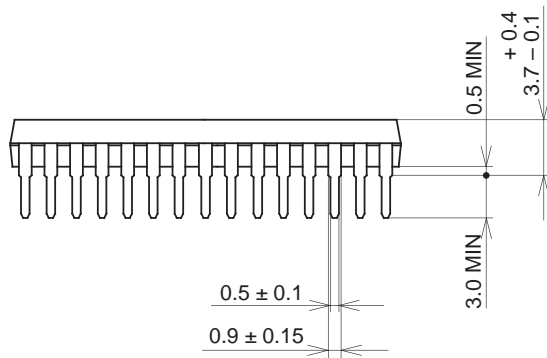
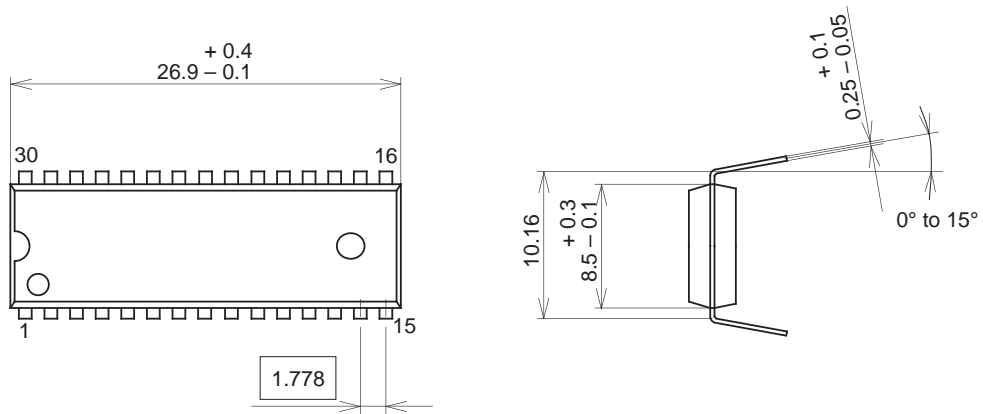

Two kinds of package surface:
 1. All mat surface type.
 2. All mirror surface type.

PACKAGE STRUCTURE

SONY CODE	SDIP-30P-01
EIAJ CODE	SDIP030-P-0400
JEDEC CODE	_____

MOLDING COMPOUND	EPOXY RESIN
LEAD TREATMENT	SOLDER/PALLADIUM PLATING
LEAD MATERIAL	COPPER ALLOY
PACKAGE MASS	1.8g

NOTE : PALLADIUM PLATING

This product uses S-PdPPF (Sony Spec.-Palladium Pre-Plated Lead Frame).