

SONY

CXA2050S

Y/C/RGB/D for PAL/NTSC Color TVs

Description

The CXA2050S is a bipolar IC which integrates the luminance signal processing, chroma signal processing, RGB signal processing, and sync and deflection signal processing functions for PAL/NTSC system color TVs onto a single chip. This IC includes deflection processing functions for wide-screen TVs, and is also equipped with a SECAM decoder interface, making it possible to construct a TV system that supports multiple color systems.

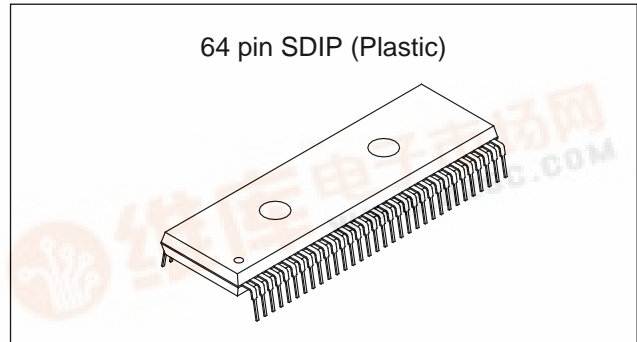

Features

- I²C bus compatible
- Compatible with both PAL and NTSC systems
(also compatible with SECAM if a SECAM decoder is connected)
- Built-in deflection compensation circuit capable of supporting various wide modes
- Countdown system eliminates need for H and V oscillator frequency adjustment
- Automatic identification of 50/60Hz vertical frequency (forced control possible)
- Non-interlace display support (even/odd selectable)
- Automatic identification of PAL, NTSC, and SECAM color systems (forced control possible)
- Automatic identification of 4.43MHz/3.58MHz crystal (forced control possible)
- Non-adjusting Y/C block filter
- One CV input, one set of Y/C inputs, two sets of analog RGB inputs (one set of which can serve as both analog and digital inputs)
- Built-in AKB circuit
- Support for forcing YS1 off

Applications

Color TVs (4:3, 16:9)

Structure

Bipolar silicon monolithic IC

Absolute Maximum Ratings (Ta = 25°C, SGND, DGND = 0V)

| | | | |
|-------------------------------|--------------------|---|----|
| • Supply voltage | SVcc1, 2, DVcc1, 2 | -0.3 to +12 | V |
| • Operating temperature | Topr | -20 to +65 | °C |
| • Storage temperature | Tstg | -65 to +150 | °C |
| • Allowable power consumption | Pd | 1.7 | W |
| • Voltages at each pin | | -0.3 to SVcc1, SVcc2, DVcc1, DVcc2 + 0.3 | V |

Operating Conditions

| | | | |
|----------------|----------|-----------|---|
| Supply voltage | SVcc1, 2 | 9.0 ± 0.5 | V |
| | DVcc1, 2 | 9.0 ± 0.5 | V |



Block Diagram

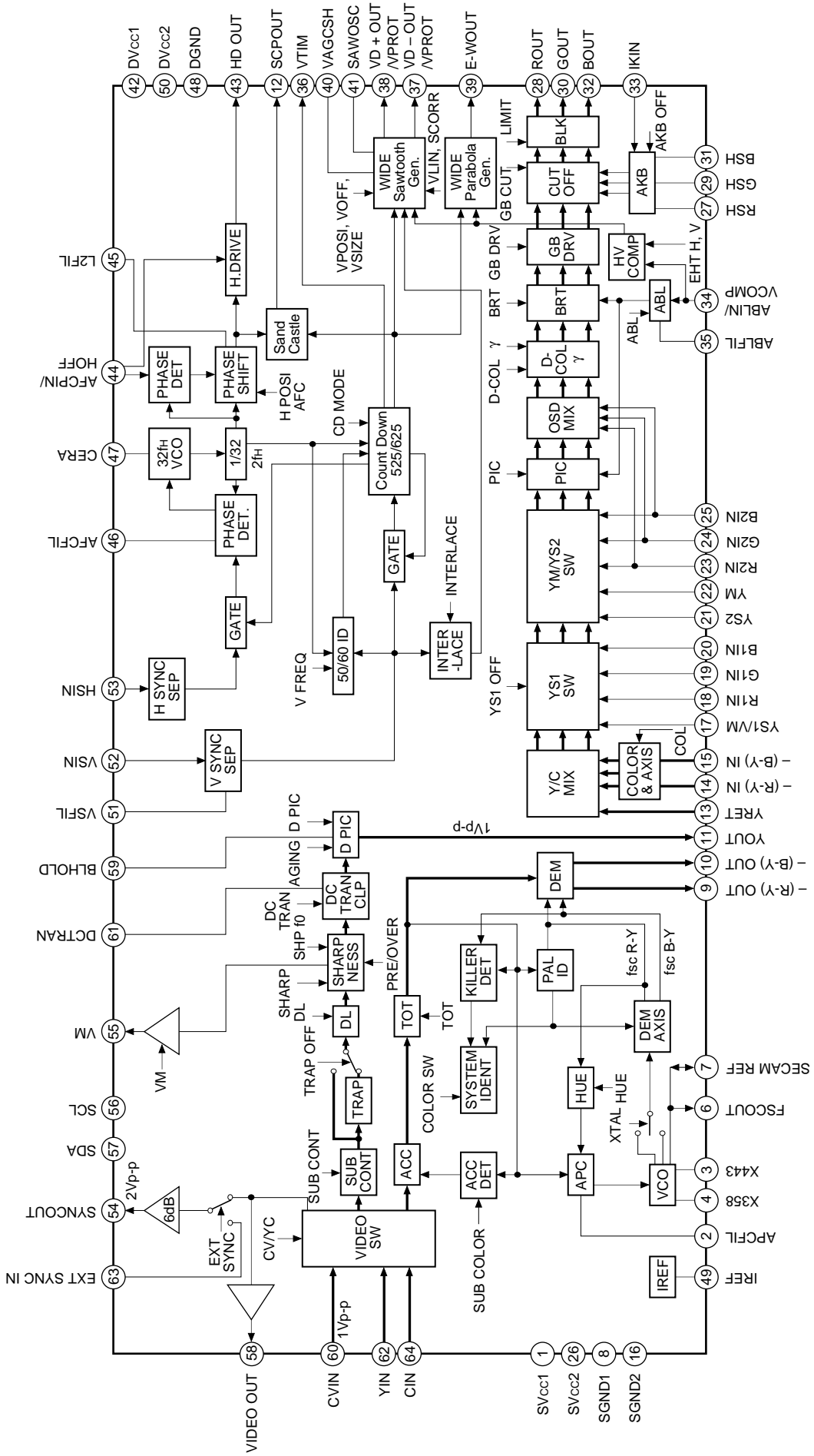

Pin Configuration



Pin Description

| Pin No. | Symbol | Equivalent circuit | Description |
|---------|--------|--------------------|---|
| 1 | SVcc1 | | Power supply for Y/C block. |
| 2 | APCFIL | | CR connection for the chroma APC lag-lead filter. |
| 3 | X443 | | Connect a 4.433619MHz crystal oscillator. |
| 4 | X358 | | Connect a 3.579545MHz crystal oscillator. |
| 5 | TEST | | Test pin. Outputs a 0 to 3V V-SYNC SEP with positive polarity. If not used, leave this pin open. |
| 6 | FSCOUT | | Subcarrier output. Output level: 5.2VDC, 0.4Vp-p |

| Pin No. | Symbol | Equivalent circuit | Description |
|---------|----------------------------|--------------------|---|
| 7 | SECAMREF | | SECAM decoder interface. This pin serves as both a 4.43MHz output and as a SECAM identification input/output pin. |
| 8 | SGND1 | — | GND for Y/C block. |
| 9 10 | - (R-Y) OUT - (B-Y) OUT | | Color difference signal outputs. Go to high impedance when the SECAM system is detected. Standard output levels for 75% CB: B-Y: 0.665Vp-p R-Y: 0.525Vp-p 5.7VDC when killer is ON. |
| 11 | YOUT | | Luminance signal output. Black level is 3.5VDC. Standard output level for 100 IRE input: 1Vp-p |
| 12 | SCPOUT | | Sand castle pulse output. The 0 to 5V BGP pulse, the phase of which is controlled through the bus, is superimposed with the 0 to 2V H and VBLK pulse for output. |
| 13 | YRET | | Luminance signal input. Clamped to 4.8V at the burst timing. Standard input level for 100 IRE input: 1Vp-p |

| Pin No. | Symbol | Equivalent circuit | Description |
|----------------|--------------------------|--------------------|--|
| 14 15 | - (R-Y) IN - (B-Y) IN | | Color difference signal inputs. Clamped to 5.5V at the burst timing. Standard input levels for 75% CB: B-Y: 1.33Vp-p R-Y: 1.05Vp-p |
| 16 | SGND2 | | GND for the RGB block. |
| 17 | YS1/VM | | Input which combines YS1SW control with VM circuit ON/OFF function. Supports with ternary. VMSW ($V_{thVM} = 0.9V$) $V_{ILVM} \leq 0.3V$ VM circuit ON $V_{IHVM} \geq 1.5V$ VM circuit OFF YS1SW ($V_{thYS1} = 2.5V$) $V_{ILYS1} \leq 1.7V$ Y/color difference input selected $V_{IHYS1} \geq 3.3V$ RGB1 input selected Setting YS1OFF of I ² C bus to 1, input for this pin is invalid. |
| 18 19 20 | R1IN G1IN B1IN | | Analog R, G and B signal inputs. Input a 0.7Vp-p (no sync, 100 IRE) signal via a capacitor. The signal is clamped to 5.7V at the burst timing of the signal input to the HSIN input (Pin 53). |
| 21 | YS2 | | YM/YS2SW YS2 control input. When YS2 is high, the RGB2 block signal is selected; when YS2 is low, the YS1SW output signal is selected. $V_{ILMAX} = 0.4V$ $V_{IHMIN} = 1.0V$ |
| 22 | YM | | YM/YS2 SW YM control input. When YM is high, the YS1SW output signal is attenuated by 6dB. $V_{ILMAX} = 0.4V$ $V_{IHMIN} = 1.0V$ |

| Pin No. | Symbol | Equivalent circuit | Description |
|----------------|----------------------|--------------------|---|
| 23 24 25 | R2IN G2IN B2IN | | <p>Analog/digital (dual-purpose) RGB signal inputs. The input signals are input via capacitors. When using analog input, input a 0.7Vp-p signal (no sync, 100 IRE); when using digital input, input a signal of at least 1.5Vp-p ($V_{th} = 1.2V$). The display level is 78 IRE. When using digital input, digital input is selected regardless of the YS2 setting. In addition, the VM output is turned off. These pins are clamped to 5.7V at the burst timing of the signal input to the HSIN input (Pin 53).</p> |
| 26 | SVcc2 | | Power supply for RGB block. |
| 27 29 31 | RSH GSH BSH | | <p>Sample-and-hold for R, G and B AKB. Connect to GND via a capacitor. When not using AKB (manual CUTOFF mode), R, G and B cut-off voltage can be controlled by applying a control voltage to each pin. The control voltage is $4.5 \pm 1V$.</p> |
| 28 30 32 | ROUT GOUT BOUT | | <p>R, G and B signal outputs. 2.5Vp-p is output during 100% white input.</p> |
| 33 | IKIN | | <p>Input the signal converted from the CRT beam current (cathode current I_k) to a voltage via a capacitor. The V blanking part is clamped to 2.7V at the V retrace timing. The input for this pin is the reference pulse return, and the loop operates so that the Rch is 1Vp-p and the G and Bch are 0.81Vp-p. The G and Bch can be varied by $\pm 0.5V$ by the bus CUTOFF control. When not using AKB, this pin should be open.</p> |

| Pin No. | Symbol | Equivalent circuit | Description |
|---------|----------------|--------------------|--|
| 34 | ABLIN/VCOMP | | <p>ABL control signal input and VSAW high voltage fluctuation compensation signal input.</p> <p>High voltage compensation has linear control characteristics for the pin voltage range of about 8V to 1V. The control characteristics can be varied through EHT-V control of the bus. ABL begins to have effect below a threshold voltage of about 1.2V.</p> <p>ABL functions as average value type.</p> |
| 35 | ABLFIL | | <p>Connect a capacitor to form the LPF of the ABL control signal.</p> |
| 36 | VTIM | | <p>V timing pulse output.</p> <p>Outputs the timing pulse from V sync identification to the end of V blanking. Pulses are positive polarity from 1 to 6V. During zoom mode, the V blanking pulse which has been expanded before and after the V sync is superimposed and output as the 1 to 3V pulse.</p> |
| 37 | VD – OUT/VPROT | | <p>V sawtooth wave output and V protect signal input.</p> <p>When a large current (3mA) is drawn from this pin, the RGB outputs are all blanked and "1" is output to the status register VNG.</p> |
| 38 | VD + OUT/VPROT | | <p>Serves as both a V sawtooth wave output with the reverse polarity of VD – OUT, and a Vprotect signal input. The Vprotect function can even be applied to this pin.</p> |

| Pin No. | Symbol | Equivalent circuit | Description |
|---------|-------------|--------------------|--|
| 39 | E-WOUT | | V parabola wave output. |
| 40 | VAGCSH | | Sample-and-hold for AGC which maintains the V sawtooth wave at a constant amplitude. Connect to GND via a capacitor. |
| 41 | SAWOSC | | Connect a capacitor to generate the V sawtooth wave. For the capacitor, use an MPS (metalized polyester capacitor), etc., with a small tan δ . |
| 42 | DVcc1 | | Power supply for the V deflection block. |
| 43 | HD OUT | | H drive signal output. This signal is output with the open collector. |
| 44 | AFCPIN/HOFF | | H deflection pulse input for H AFC. Input an about 5Vp-p pulse via a capacitor. Set the pulse width to 10 to 12 μ s. This pin is also used as the hold-down signal input for the HD output, and if this pin is 1V or less for a 7V cycle or longer, the hold-down function operates and the HD output is held to 9VDC. In addition, the RGB outputs are all blanked. Outputs "1" to the status register XRAY. |

| Pin No. | Symbol | Equivalent circuit | Description |
|---------|--------|--------------------|---|
| 45 | L2FIL | | <p>Filter for H AFC. Connect to GND via a capacitor. The H phase can also be controlled from this pin by leading current in and out of this capacitor. As the pin voltage rises, the picture shifts to the left; as the pin voltage drops, the picture shifts to the right.</p> |
| 46 | AFCFIL | | <p>CR connection for the AFC lag-lead filter.</p> |
| 47 | CERA | | <p>Connect the 32 x FH VCO ceramic oscillator.</p> |
| 48 | DGND | | <p>GND for the deflection block.</p> |
| 49 | IREF | | <p>Internal reference current setting. Connect to GND via a resistor with an error of less than 1% (such as a metal film resistor).</p> |
| 50 | DVcc2 | | <p>Power supply for the H deflection block.</p> |
| 51 | VSFIL | | <p>Filter for V sync separation. Connect to GND via a capacitor.</p> |

| Pin No. | Symbol | Equivalent circuit | Description |
|---------|---------|--------------------|---|
| 52 | VSIN | | <p>Sync signal input for V sync separation. Input a 2Vp-p Y signal (or a 0.6Vp-p sync signal).</p> |
| 53 | HSIN | | <p>Sync signal input for H sync separation. Input a 2Vp-p Y signal (or a 0.6Vp-p sync signal).</p> |
| 54 | SYNCOUT | | <p>Sync signal output for VSIN and HSIN. The output can be selected from the internal sync signals (Pin 60 or Pin 62) or the external sync signal (Pin 63) by the I²C bus. Output signal level: 2Vp-p (0.6Vp-p sync only) Input/output gain: 6dB</p> |
| 55 | VM | | <p>Outputs the differential waveform of the VM (Velocity Modulation) Y signal. The signal advanced for 200ns from YOUT is output. The delay time versus YIN is determined by the DL setting of the I²C bus. This output level can be set at 2.65Vp-p or 1.1Vp-p by the I²C bus. Pedestal level is DC6.2V. This output can also be turned off by YS1, YM, and YS2.</p> |
| 56 | SCL | | <p>I²C bus protocol SCL (Serial Clock) input. VILMAX = 1.5V VIHMIN = 3.5V</p> |

| Pin No. | Symbol | Equivalent circuit | Description |
|---------|-----------|--------------------|---|
| 57 | SDA | | <p>I²C bus protocol SDA (Serial Data) I/O. VILMAX = 1.5V VIHMIN = 3.5V VOLMAX = 0.4V</p> |
| 58 | VIDEO OUT | | <p>The input signal from CVIN pin and YIN pin is selected by I²C bus, and output externally.</p> |
| 59 | BLHOLD | | <p>Capacitor connection for black peak hold of the dynamic picture (black expansion).</p> |
| 60 | CVIN | | <p>Composite video signal input. Input the 1Vp-p (100% white including sync) CV signal via a capacitor. The sync level of the input signal is clamped to 3.8V. In addition, this pin detects input video signal HSYNC, and outputs the status via the status register CVSYNC.</p> |
| 61 | DCTRAN | | <p>Connect a capacitor that determines the DC transmission ratio to GND.</p> |



| Pin No. | Symbol | Equivalent circuit | Description |
|---------|-------------|--------------------|---|
| 62 | YIN | | <p>Y signal input. Input a 1Vp-p (100% white including sync) Y signal via a capacitor. The sync level of the input signal is clamped to 3.8V.</p> |
| 63 | EXT SYNC IN | | <p>External sync signal input. Input a 0.3Vp-p sync signal (or a 1Vp-p CV signal or Y signal) via a capacitor. The sync level of the input signal is clamped to 3.8V.</p> |
| 64 | CIN | | <p>Chroma signal input. Input a C signal with a burst level of 300mVp-p via a capacitor. Input signal is biased to 4.5V internally.</p> |



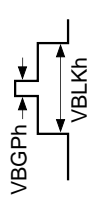
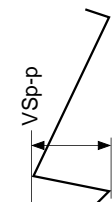
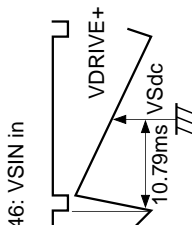

Electrical Characteristics

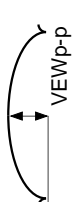
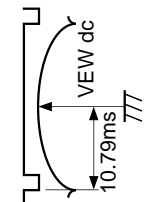
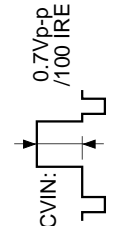
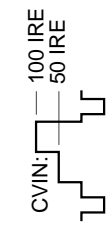
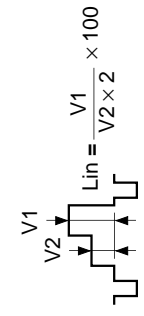
Setting conditions • Ta = 25°C, SVcc1, 2 = DVcc1, 2 = 9V, SGND1, 2 = DGND = 0V

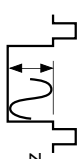
• Measures the following after setting the I²C bus register as shown in "I²C Bus Register Initial Settings".

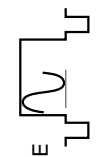
| No. | Item | Symbol | Measurement conditions | Measurement pins | Measurement contents | Min. | Typ. | Max. | Unit |
|------------------------------------|-----------------------------------|--------|--|------------------|---|--|--------|-------|------|
| 1 | Signal block current consumption | SICC | Vcc = 9.0V, Bus data = center | 1, 26 | Measure the pin inflow current. | 40 | 67 | 90 | mA |
| 2 | Sync block current consumption | DICC | Vcc = 9.0V, Bus data = center | 42, 50 | Measure the pin inflow current. | 30 | 49 | 65 | mA |
| Sync deflection block items | | | | | | | | | |
| 3 | Horizontal free-running frequency | fHFR | AFC MODE = 0h | 43 | HDRIVE output frequency | 15.55 | 15.734 | 15.90 | kHz |
| 4 | Horizontal sync pull-in range | ΔfHR | SYNCIN: composite sync | — | Confirm that I ² C status register HLOCK is 1 (the pull-in range when fH is shifted from 15.734kHz). | -400 | — | 400 | Hz |
| 5 | HD output pulse width | HDw | SYNCIN: composite sync | 43 | Measure the pulse width for the section where the HDRIVE output is high. | 24.5 | 25.5 | 26.5 | μs |
| 6 | SCP BLK output pulse width | VBLKh | SCP Measure the pulse width for the section where the BLK output is high. | 12 |  | 11.6 | 12.1 | 12.6 | μs |
| | | | | | | 3.35 | 3.75 | 4.15 | μs |
| 8 | VDRIVE output amplitude | VSp-p | SYNCIN: composite sync | 37, 38 | Measure the VDRIVE output Vp-p. | 0.9 | 1.0 | 1.1 | V |
| | | | | | |  | | | |
| 9 | VDRIVE output center potential | VSdc | SYNCIN: composite sync | 37, 38 | 46: VSIN in Measure the VDRIVE output Vp-p. | 2.9 | 3.0 | 3.1 | V |
| | | | | | |  | | | |

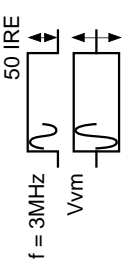
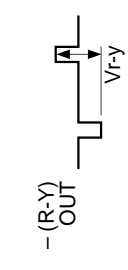
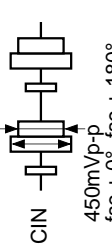
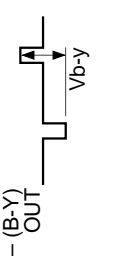
| No. | Item | Symbol | Measurement conditions | Measurement pins | Measurement contents | Min. | Typ. | Max. | Unit |
|---------------------------|---------------------------------|------------|--|------------------|---|------|------|------|------|
| 10 | EWDRIVE output amplitude | VEWp-p | SYNCIN: composite sync | 39 | Measure the EWDRIVE output Vp-p.  | 0.42 | 0.52 | 0.62 | V |
| 11 | EWDRIVE output center potential | VEWdc | | 39 | 46: VSIN in  | 3.8 | 3.95 | 4.1 | V |
| Signal block items | | | | | | | | | |
| 12 | R, G and B output amplitude | VROUT1 | CVIN:  | 28, 30, 32 | Output amplitude when a video signal with an amplitude of 0.7Vp-p/100 IRE is input. | 2.25 | 2.5 | 2.85 | V |
| 13 | R, G and B output linearity | Lin | CVIN:  | 28, 30, 32 |  | 96 | 100 | 104 | % |
| 14 | C-TRAP attenuation (3.58MHz) | C-Trap3.58 | CVIN:  TRAPOFF = 0/1 TRAP-F0 = 7h | 28 | Input fsc to CVIN. Ratio of the fsc component of the Yout amplitude when CTRAP = 1 against the Yout amplitude when CTRAP = 0.  | — | -38 | — | dB |

| No. | Item | Symbol | Measurement conditions | Measurement pins | Measurement contents | Min. | Typ. | Max. | Unit |
|-----|-----------------------------------|---------------------|--|------------------|--|------|------|------|------|
| 15 | C-TRAP attenuation (4.43MHz) | C-Trap4.43 |  CVIN: fsc, 50 IRE TRAPOFF = 0/1 TRAP-F0 = 7h | 28 | Input fsc to CVIN. Ratio of the fsc component of the Yout amplitude when CTRAP = 1 against the Yout amplitude when CTRAP = 0.  | — | -31 | — | dB |
| 16 | VM output | V _{vm} | CVIN: 3MHz, 50 IRE VM = 1 | 55 |  | 1.95 | 2.3 | 2.65 | V |
| 17 | Color difference -(R-Y) output | V _{r-y} | 4.43MHz PAL input burst fsc 300mVp-p 640mVp-p fsc + 90° | 9 |  | 440 | 510 | 570 | mV |
| 18 | Color difference -(B-Y) output | V _{b-y} |  CIN 450mVp-p fsc + 0°, fsc + 180° SUB-COLOR = 7h | 10 |  | 570 | 640 | 710 | mV |
| 19 | Color gain -(R-Y) | V _{colr-y} | -(R-Y) IN: 525mVp-p PAL input: COLOR = 1Fh | 28 |  | 1.1 | 1.3 | 1.5 | V |
| 20 | Color gain -(B-Y) | V _{colb-y} | -(B-Y) IN: 665mVp-p PAL input: COLOR = 1Fh | 30 |  | 1.4 | 1.6 | 1.8 | V |

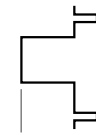
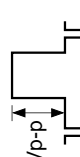
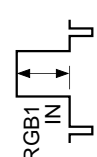
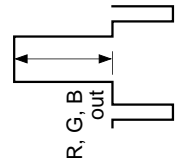
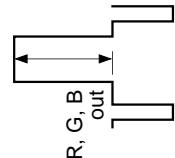
| No. | Item | Symbol | Measurement conditions | Measurement pins | Measurement contents | Min. | Typ. | Max. | Unit |
|-----|---|-----------------|--|------------------|--|------|------|------|------|
| 21 | Hue center offset | ϕ offset | HUE = 1Fh, SUB – HUE = 7h | — | | -9 | 0 | 9 | deg |
| 22 | Killer point | KP | CVIN: Burst only | — | | — | -37 | — | dB |
| 23 | APC pull-in range | Δ APC | | — | Confirm that the burst frequency is pulled in at 3.58MHz \pm 400Hz. | -400 | — | 400 | Hz |
| 24 | Dynamic color operation R output | Δ GdcolR | CVIN: 100IRE  | 28 | ROUT, BOUT  | 94 | 96 | 98 | % |
| 25 | Dynamic color operation B output | Δ GdcolB | D-COL = 0/1 | 30 | $\Delta\text{GdcolR} = \frac{V_{p-p}(\text{DCOL} = 1)}{V_{p-p}(\text{DCOL} = 0)} \times 100$ $\Delta\text{GdcolB} = \frac{V_{p-p}(\text{DCOL} = 1)}{V_{p-p}(\text{DCOL} = 0)} \times 100$ | 102 | 104 | 106 | % |
| 26 | YM gain | Δ GYM | | 28, 30, 32 | Output amplitude ratio when the R, G and BOUT YM = 1 and 0 | -7.1 | -6.1 | -5.1 | dB |
| 27 | R output amplitude during linear R1 input | VLR1out | YS1: 5V RGB1IN: 0.7Vp-p | 28 |  | 1.85 | 2.05 | 2.25 | V |
| 28 | G output amplitude during linear G1 input | VLG1out | YS1: 5V RGB1IN: 0.7Vp-p | 30 |  | 1.85 | 2.05 | 2.25 | V |
| 29 | B output amplitude during linear B1 input | VLB1out | YS1: 5V RGB1IN: 0.7Vp-p | 32 |  | 1.85 | 2.05 | 2.25 | V |

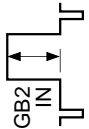
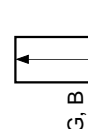
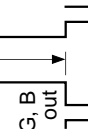
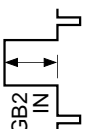
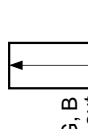
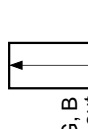
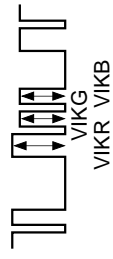
| No. | Item | Symbol | Measurement conditions | Measurement pins | Measurement contents | Min. | Typ. | Max. | Unit |
|-----|--|---------|---|------------------|--|------|------|------|------|
| 30 | R output amplitude during linear R2 input | VLR2out | YS2: 1V RGB2IN: 0.7Vp-p | 28 |  VLR2out = Vout | 1.85 | 2.05 | 2.25 | V |
| 31 | G output amplitude during linear G2 input | VLG2out | YS2: 1V RGB2IN: 0.7Vp-p | 30 |  VLG2out = Vout | 1.85 | 2.05 | 2.25 | V |
| 32 | B output amplitude during linear B2 input | VLB2out | YS2: 1V RGB2IN: 0.7Vp-p | 32 |  VLB2out = Vout | 1.85 | 2.05 | 2.25 | V |
| 33 | R output amplitude during digital R2 input | VDRout | RGB2IN: 1.5Vp-p | 28 |  VDRout = Vout | 70 | 78 | 86 | IRE |
| 34 | G output amplitude during digital G2 input | VDGout | RGB2IN: 1.5Vp-p | 30 |  VDGout = Vout | 70 | 78 | 86 | IRE |
| 35 | B output amplitude during digital B2 input | VDBout | RGB2IN: 1.5Vp-p | 32 |  VDBout = Vout | 70 | 78 | 86 | IRE |
| 36 | IK level R | VIKR | SYNCRIN: composite sync GCUTOFF = 0h BCUTOFF = 0h | 33 |  | 0.85 | 1.00 | 1.15 | V |
| 37 | IK level G | VIKG | | 33 | | 0.22 | 0.35 | 0.5 | V |
| 38 | IK level B | VIKB | | 33 | | 0.22 | 0.35 | 0.5 | V |

Electrical Characteristics Measurement Circuit

Signal sources  are all GND unless otherwise specified in the Measurement conditions column of Electrical Characteristics.

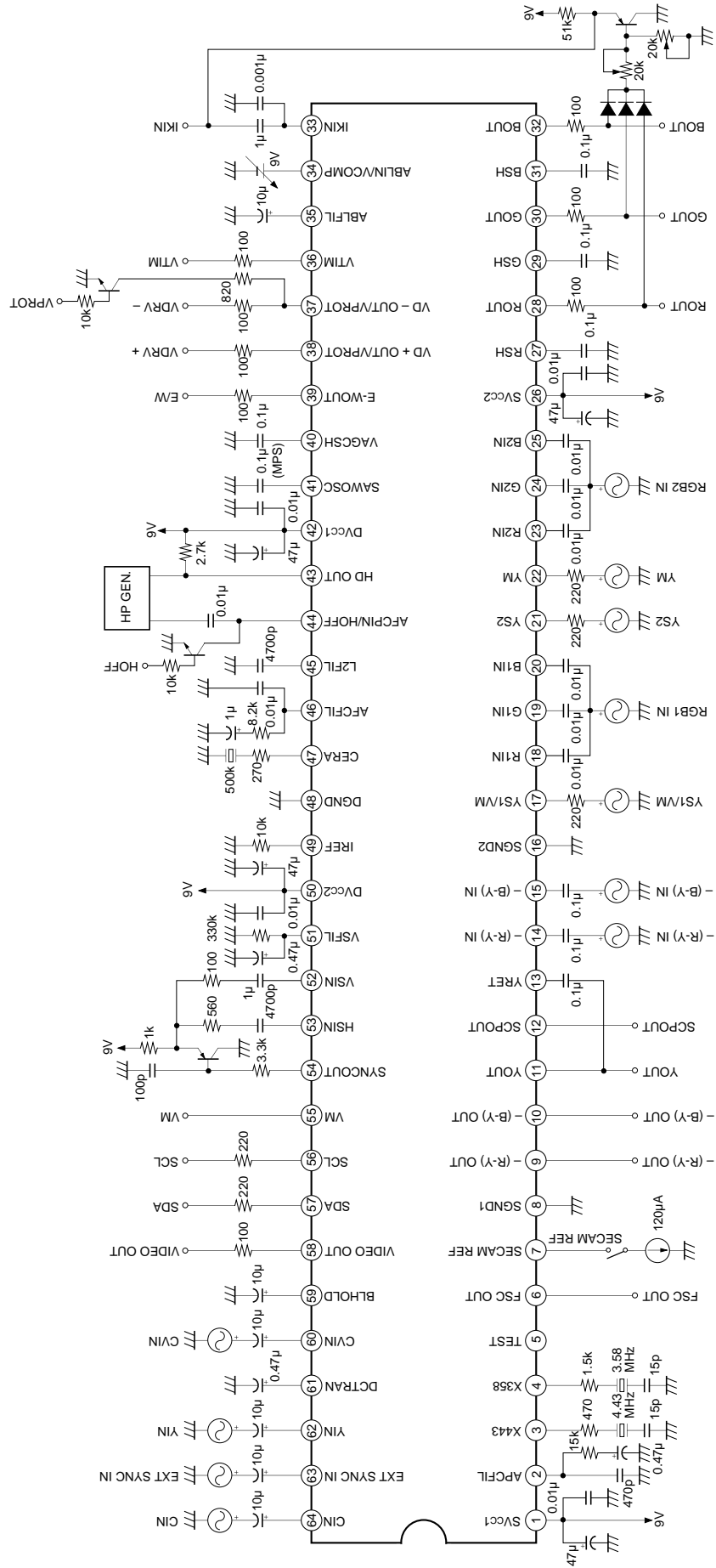

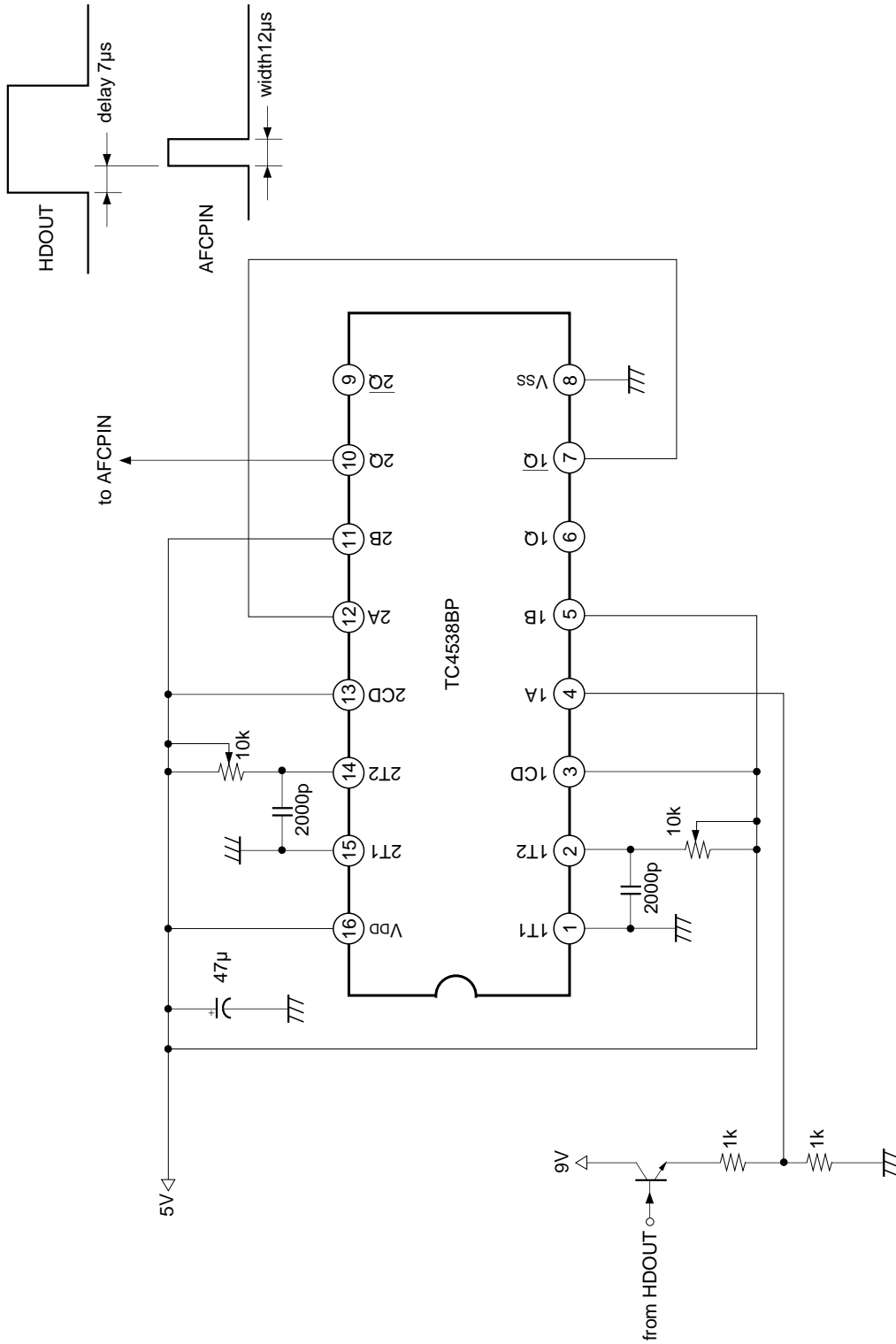

Application Circuit

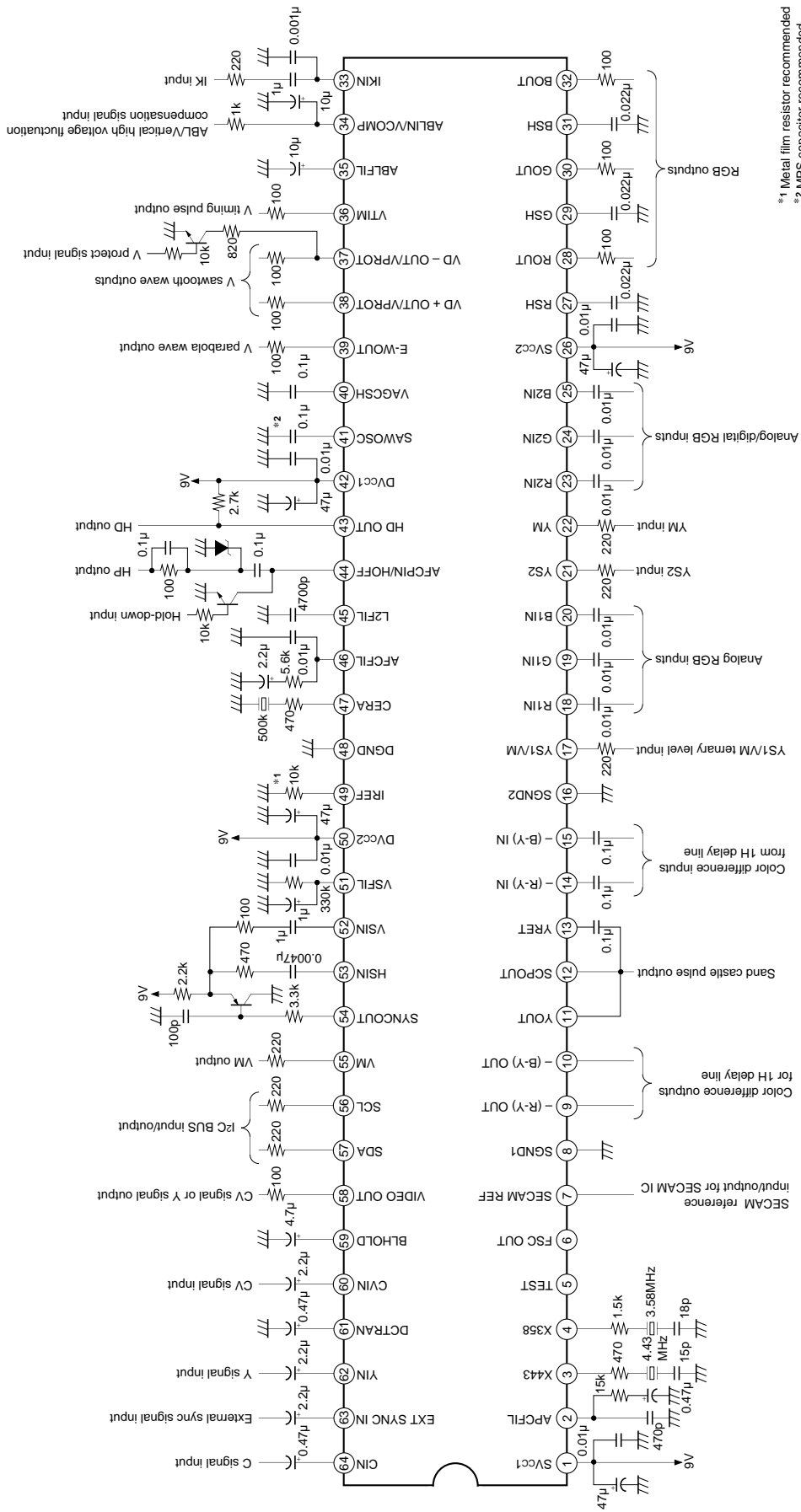

*1 Metal film resistor recommended
*2 MPS capacitor recommended

Application circuits shown are typical examples illustrating the operation of the devices. Sony cannot assume responsibility for any problems arising out of the use of these circuits or for any infringement of third party patent and other right due to same.

Electrical Characteristics Measurement Conditions "I²C Bus Register Initial Settings"

| Register name | No. of bits | Initial setting | Description |
|---------------|-------------|-----------------|-------------------------|
| PICTURE | 6 | 3Fh | Maximum value |
| TRAPOFF | 1 | 1h | TRAP off |
| VM | 1 | 1h | Maximum value |
| HUE | 6 | 1Fh | Center value |
| DCTRAN | 1 | 0h | DCTRAN off |
| D-PIC | 1 | 0h | DPIC off |
| COLOR | 6 | 1Fh | Center value |
| TOT | 1 | 0h | TOT off |
| ABL | 1 | 0 | Picture/bright ABL mode |
| BRIGHT | 6 | 1Fh | Center value |
| D-COL | 1 | 0h | DCOL off |
| LIMIT | 1 | 0 | Limiter off |
| SHARPNESS | 4 | 7h | Center value |
| PRE-OVER | 2 | 3h | Maximum value |
| COLOR SW | 2 | 0h | Automatic switching |
| SUB-CONT | 4 | 7h | Center value |
| TRAP F0 | 4 | 7h | Center value |
| SUB-COLOR | 4 | 7h | Center value |
| SUB-HUE | 4 | 7h | Center value |
| SUB-BRIGHT | 6 | 1Fh | Center value |
| GAMMA | 2 | 0h | Minimum value |
| G-DRIVE | 6 | 2Ah | Center value |
| AGING | 1 | 0h | AGING off |
| B-DRIVE | 6 | 2Ah | Center value |
| INTERLACE | 2 | 0h | Interlace |
| G-CUTOFF | 4 | 0h | Minimum value |
| B-CUTOFF | 4 | 0h | Minimum value |
| RON | 1 | 1h | R output on |
| GON | 1 | 1h | G output on |
| BON | 1 | 1h | B output on |
| PICON | 1 | 1h | Picture mute off |
| VOFF | 1 | 0h | VD output on |
| FHHI | 1 | 0h | FH normal |
| CD-MODE | 1 | 0h | Automatic switching |
| AKBOFF | 1 | 0h | AKB on |
| V-SIZE | 6 | 1Fh | Center value |

| Register name | No. of bits | Initial setting | Description |
|---------------|-------------|-----------------|---------------------|
| V FREQ | 2 | 0h | Automatic switching |
| V-POSITION | 6 | 1Fh | Center value |
| AFC-MODE | 2 | 1h | Low gain |
| S-CORR | 4 | 0h | Minimum value |
| V-LIN | 4 | 7h | Center value |
| H-SIZE | 6 | 1Fh | Center value |
| REF-POSI | 2 | 3h | Maximum value |
| PIN-COMP | 6 | 1Fh | Center value |
| VBLKW | 2 | 0h | Minimum value |
| H-POSITOPN | 4 | 7h | Center value |
| PIN-PHASE | 4 | 7h | Center value |
| AFC-BOW | 4 | 7h | Center value |
| AFC-ANGLE | 4 | 7h | Center value |
| EHT H | 2 | 0h | EHT H off |
| EHT V | 2 | 0h | EHT V off |
| XTAL | 2 | 0h | Automatic switching |
| EXT SYNC | 1 | 0h | Internal sync |
| CV/YC | 1 | 0h | CV input |
| V-ASPECT | 6 | 0h | Minimum value |
| ZOOM SW | 1 | 0h | ZOOM SW off |
| HBLKSW | 1 | 0h | HBLKSW off |
| V-SCROLL | 6 | 1Fh | Center value |
| JMP SW | 1 | 0h | JMP SW off |
| HSIZESW | 1 | 0h | HSIZESW off |
| UP-VLIN | 4 | 0h | Minimum value |
| LO-VLIN | 4 | 0h | Minimum value |
| LEFT-BLK | 4 | 7h | Center value |
| RIGHT-BLK | 4 | 7h | Center value |
| UP-CPIN | 4 | 7h | Center value |
| LO-CPIN | 4 | 7h | Center value |
| CDMODE2 | 1 | 0 | Standard mode |
| SHPF0 | 1 | 0 | 3MHz |
| YS1OFF | 1 | 0h | YS1 normal |
| DL | 3 | 3h | Center value |

Definition of I²C Bus Registers

Slave Addresses

- 88h: Slave Receiver
- 89h: Slave Transmitter

Register Table

"*": Undefined

Control Register

| Sub Address | Bit7 | Bit6 | Bit5 | Bit4 | Bit3 | Bit2 | Bit1 | Bit0 | |
|---------------|------------|-------|-------|-----------|---------|------|-----------|---------|--|
| xxx00000 00 h | PICTURE | | | | | | TRAPOFF | VM | |
| xxx00001 01 h | HUE | | | | | | DC-TRAN | D-PIC | |
| xxx00010 02 h | COLOR | | | | | | TOT | ABL | |
| xxx00011 03 h | BRIGHT | | | | | | D-COL | LIMIT | |
| xxx00100 04 h | SHARPNESS | | | PRE-OVER | | | COLOR SW | | |
| xxx00101 05 h | SUB-CONT | | | TRAP F0 | | | | | |
| xxx00110 06 h | SUB-COLOR | | | SUB-HUE | | | | | |
| xxx00111 07 h | SUB-BRIGHT | | | | | | GAMMA | | |
| xxx01000 08 h | G-DRIVE | | | | | | AGING | 0 | |
| xxx01001 09 h | B-DRIVE | | | | | | INTERLACE | | |
| xxx01010 0A h | G-CUTOFF | | | B-CUTOFF | | | | | |
| xxx01011 0B h | RON | GON | BON | PICON | VOFF | FHHI | CD-MODE | AKBOFF | |
| xxx01100 0C h | V-SIZE | | | | | | V-FREQ | | |
| xxx01101 0D h | V-POSITION | | | | | | AFC-MODE | | |
| xxx01110 0E h | S-CORR | | | V-LIN | | | | | |
| xxx01111 0F h | H-SIZE | | | | | | REF-POSI | | |
| xxx10000 10 h | PIN-COMP | | | | | | VBLKW | | |
| xxx10001 11 h | H-POSITION | | | PIN-PHASE | | | | | |
| xxx10010 12 h | AFC-BOW | | | AFC-ANGLE | | | | | |
| xxx10011 13 h | EHT H | | EHT V | | XTAL | | EXT SYNC | CV/YC | |
| xxx10100 14 h | V-ASPECT | | | | | | ZOOM SW | HBLKSW | |
| xxx10101 15 h | V-SCROLL | | | | | | JMP SW | HSIZESW | |
| xxx10110 16 h | UP-VLIN | | | LO-VLIN | | | | | |
| xxx10111 17 h | LEFT-BLK | | | RIGHT-BLK | | | | | |
| xxx11000 18 h | UP-CPIN | | | LO-CPIN | | | | | |
| xxx11001 19 h | CDMODE2 | SHPF0 | * | * | YS1 OFF | DL | | | |

Status Register

| Bit7 | Bit6 | Bit5 | Bit4 | Bit3 | Bit2 | Bit1 | Bit0 |
|--------|------|------|------|-----------|------|------|------|
| H LOCK | IKR | VNG | XRAY | COLOR SYS | | FSC | FV |

Description of Registers

Register name (No. of bits)

1. Video switch register

- CV/YC (1) : CV input/YC input selector
 0 = CV input selected
 1 = YC input selected
- EXT SYNC (1) : EXT SYNC selector switch
 0 = Internal sync (CV or Y) selected
 1 = EXT SYNC selected

2. Y signal block register

- SUB-CONT (4) : Contrast gain control (Y gain control)
 0h = -3.5dB
 7h = 0dB
 Fh = +2.5dB
- TRAP-F0 (4) : Chroma trap f0 fine adjustment
 0h = High
 7h = Center
 Fh = Low
- SHARPNESS (4) : Sharpness gain control
 0h = -6dB
 7h = +2.5dB
 Fh = +6.5dB
- SHPF0 (1) : Sharpness f0 selector
 0 = 3MHz
 1 = 3.5MHz
- PRE-OVER (2) : Sharpness preshoot/overshoot ratio control
 0h = 1:1 (PRE: OVER)
 3h = 2:1
- VM (1) : Y differential signal output level selector for VM (for 100% 3MHz input)
 0 = 1.1Vp-p
 1 = 2.65Vp-p
- TRAP OFF (1) : Y block chroma trap ON/OFF
 0 = Trap ON
 1 = Trap OFF
- DL (3) : Y signal delay time control (80ns/step)
 0h = Max.
 7h = Min.

- DC-TRAN (1) : Y DC transmission ratio selector switch
 0 = 100%
 1 = 81%
- D-PIC (1) : Y black expansion ON/OFF switch
 0 = OFF
 1 = ON Point of inflection: 30 IRE

3. C signal block register

- TOT (1) : Chroma TOT filter band selector switch
 0 = TOT — TRAP OFF
 1 = TOT — TRAP ON (TRAP fo 2MHz)
- COLOR (6) : Color gain control (Chroma gain control)
 0h = Color OFF (−40dB or less)
 1Fh = 0dB B output: 1.02Vp-p (I/O gain: +11dB, 0.285Vp-p input)
 3Fh = +6dB
- SUB-COLOR (4) : Color gain control (ACC reference level control)
 0h = −5dB
 7h = 0dB
 Fh = +3dB
- HUE (6) : Hue control (Phase control for chroma demodulation axis when SUB-HUE is 7h)
 Control not possible for a PAL system.
 0h = +35° Flesh color appears red.
 1Fh = 0°
 3Fh = −35° Flesh color appears green.
- SUB-HUE (4) : Hue control (Phase control for chroma demodulation axis when HUE is 1Fh)
 B-Y axis adjustable to 0°.
 Control not possible for a PAL system.
 0h = +10°
 7h = 0°
 Fh = −10°
- XTAL (2) : XTAL selection setting switch
 0h = Automatic identification
 1h = Force to XTAL1 (3.58MHz)
 2, 3h = Force to XTAL2 (4.43MHz)
- COLOR SW (2) : Color system setting
 0h = Automatic identification
 1h = Force to PAL
 2h = Force to NTSC
 3h = Force to SECAM

4. RGB signal block register

| | | |
|------------|-----|--|
| PICTURE | (6) | : Picture gain control (RGB gain control) 0h = -14dB 3Fh = 0dB RGB output: 2.5Vp-p (I/O gain: +8dB, 1Vp-p input) |
| BRIGHT | (6) | : Bright control (RGB DC bias control) 0h = -420mV 1Fh = 0mV (-300mV for REF-P level) 3Fh = +420mV |
| SUB-BRIGHT | (6) | : Bright control (RGB DC bias control) 0h = -420mV 1Fh = 0mV (-300mV for REF-P level) 3Fh = +420mV |
| G-DRIVE | (6) | : Gch drive gain adjustment (Gch gain control) 0h = G/R -4.5dB 2Ah = G/R 0dB (G/R 0dB) 3Fh = G/R +1.5dB |
| B-DRIVE | (6) | : Bch drive gain adjustment (Bch gain control) 0h = B/R -4.5dB 2Ah = B/R 0dB (B/R 0dB) 3Fh = B/R +1.5dB |
| G-CUTOFF | (4) | : Gch cut-off adjustment (Gch reference pulse value control of IKIN pin input) 0h = +34% 7h = +81% (G/R) Fh = +135% |
| B-CUTOFF | (4) | : Bch cut-off adjustment (Bch reference pulse value control of IKIN pin input) 0h = +34% 7h = +81% (B/R) Fh = +135% |
| D-COL | (1) | : Dynamic color ON/OFF switch 0 = Dynamic color OFF 1 = Dynamic color ON (R, Bch level control) |
| GAMMA | (2) | : Gamma control (RGB gamma correction amount control) 0h = Gamma OFF 3h = Gamma peak 17 IRE (at input 40 IRE), +400mV (at 2.5Vp-p OUT) |

| | | |
|------------------|---|--|
| REF-POSITION (2) | : | Reference pulse timing setting 0h = From rising edge of V TIM: Rch 22H, Gch 23H, Bch 24H 1h = From rising edge of V TIM: Rch 20H, Gch 21H, Bch 22H 2h = From rising edge of V TIM: Rch 18H, Gch 19H, Bch 20H 3h = From rising edge of V TIM: Rch 16H, Gch 17H, Bch 18H |
| PIC-ON (1) | : | ON/OFF switch for RGB output with a reference pulse (Set to OFF mode at power-on.) 0 = RGB output OFF (All blanked status) 1 = RGB output ON |
| R ON (1) | : | ON/OFF switch for Rch video output without a reference pulse (Operates when PIC ON = 1, set to OFF mode at power-on.) 0 = Rch video output OFF (Blanked status, reference pulse only output) 1 = Rch video output ON |
| G ON (1) | : | ON/OFF switch for Gch video output without a reference pulse (Operates when PIC ON = 1, set to OFF mode at power-on.) 0 = Gch video output OFF (Blanked status, reference pulse only output) 1 = Gch video output ON |
| B ON (1) | : | ON/OFF switch for Bch video output without a reference pulse (Operates when PIC ON = 1, set to OFF mode at power-on.) 0 = Bch video output OFF (Blanked status, reference pulse only output) 1 = Bch video output ON |
| AKB OFF (1) | : | AKB ON/OFF switch (Set to ON mode at power-on.) 0 = AKB ON 1 = AKB OFF (IK CLAMP, IK S/H and reference pulse fixed to OFF) R, G and B cut-off adjustment at AKB OFF performed by voltage applied to RSH, GSH and BSH pins, respectively. |
| YS1 OFF (1) | : | YS1 forced OFF mode/YS1 normal mode 0 = YS1 normal mode 1 = YS1 forced OFF mode |
| ABL (1) | : | ABL mode selector 0 = Picture/bright ABL mode 1 = Picture ABL mode |
| LIMIT (1) | : | Peak limiter (RGBOUT pin is limited at DC5.2V) 0 = OFF 1 = ON |

5. Deflection block register

| | | |
|------------|-----|---|
| AFC-MODE | (2) | : AFC loop gain control (PLL between H SYNC and H VCO) 0h = H free run mode 1h = Small gain 2h = Medium gain 3h = Large gain |
| FH-HI | (1) | : H oscillator frequency fixation ON/OFF switch (Set to ON mode at power-on.) 0 = H oscillator frequency fixation OFF AFC normal mode 1 = H oscillator frequency fixation ON Oscillator frequency fixed to maximum value (approx. 16.2kHz) |
| V FREQ | (1) | : V frequency mode setting 0, 1h = Automatic identification 2h = Forced mode (50Hz) 3h = Forced mode (60Hz) |
| V OFF | (1) | : V sawtooth wave oscillation stop ON/OFF switch (Set to OFF mode at power-on.) 0 = Oscillation stop OFF (V DRIVE- and V DRIVE+: normal output) 1 = Oscillation stop ON (V DRIVE- and V DRIVE+: DC output and DC value vary according to V POSITION.) |
| CD-MODE | (1) | : V countdown system mode selector (Set to automatic selection mode during power-on.) 0 = Non-standard signal mode, standard signal mode and no signal mode automatically selected 1 = Fixed to non-standard signal mode (V oscillator frequency is 55Hz during no signal mode "free run".) |
| CDMODE2 | (1) | : Vertical sync pull-in speed selector 0 = Standard 1 = High speed |
| VBLKW | (2) | : VBLK width control (Blanked pulses after reference pulse. Operates when JMPSW = 1; blanked pulses after reference pulse fixed to 1H when JMPSW = 0.) 0h = 12H from Bch reference pulse 1h = 11H from Bch reference pulse 2h = 10H from Bch reference pulse 3h = 9H from Bch reference pulse |
| H-POSITION | (4) | : Horizontal position adjustment (HAFC phase control) 0h = 1 μ s delay Picture position shifts to right. (Picture delayed with respect to HD.) 7h = 0 μ s Fh = 1 μ s advance Picture position shifts to left. (Picture advanced with respect to HD.) |
| V-POSITION | (6) | : Vertical position adjustment (V SAW output DC bias control) 0h = -0.09V Picture position drops, V DRIVE+ output DC Down. 1Fh = 0V Center potential: DC 3V 3Fh = +0.09V Picture position rises, V DRIVE+ output DC Up. |

| | | |
|-----------|-----|---|
| V-SIZE | (6) | : Vertical amplitude adjustment (V SAW output gain control) 0h = -14% Vertical picture size decreases. 1Fh = 0% Amplitude: 1.23Vp-p, center potential: DC 3V when V-ASPECT is 2Fh. 3Fh = +14% Vertical picture size increases. |
| V-LIN | (4) | : Vertical linearity adjustment (Gain control for V SAW secondary component) 0h = 115% (Bottom/top of picture) Top of picture compressed; bottom of picture expanded. 7h = 100% (Bottom/top of picture) Fh = 85% (Bottom/top of picture) Top of picture expanded; bottom of picture compressed. |
| S-CORR | (4) | : Vertical S correction amount adjustment (V SAW secondary component gain control) 0h = Secondary component amplitude by adding sawtooth = 0 Fh = Secondary component amplitude by adding sawtooth = Maximum |
| AFC-BOW | (4) | : Vertical line bow compensation amount adjustment (Phase control according to HAFC parabola wave) 0h = Top and bottom of picture delayed 500ns with respect to picture center. 7h = 0 ns Fh = Top and bottom of picture advanced 500ns with respect to picture center. |
| AFC-ANGLE | (4) | : Vertical line slope compensation amount adjustment (Phase control according to HAFC V SAW) 0h = Top of picture delayed 400ns, bottom of picture advanced 400ns with respect to picture center. 7h = 0 ns Fh = Top of picture advanced 400ns, bottom of picture delayed 400ns with respect to picture center. |
| PIN-COMP | (6) | : Horizontal pin distortion compensation amount adjustment (V parabola wave gain control) 0h = 0.10Vp-p Horizontal size for top/bottom of picture increases. (Compensation amount minimum) 1Fh = 0.58Vp-p Amplitude, center potential: DC 4V when V-ASPECT is 0h 3Fh = 1.06Vp-p Horizontal size for top/bottom of picture decreases. (Compensation amount maximum) |
| H-SIZE | (6) | : Horizontal amplitude adjustment (V parabola wave DC bias control) 0h = -0.5V Horizontal picture size decreases, EW-DRIVE output DC Down. 1Fh = 0V Amplitude: 0.58Vp-p, center potential: DC 4 V when V-ASPECT is 2Fh 3Fh = +0.5V Horizontal picture size increases, EW-DRIVE output DC Up. |
| EHT-H | (2) | : Horizontal high-voltage fluctuation compensation amount setting (DC adjustment for parabolic output) 0h = 0V (Compensation amount when 1V is applied to ABL IN versus 8V applied to ABL IN) 3h = -0.1V (Compensation amount when 1V is applied to ABL IN versus 8V applied to ABL IN) |
| EHT-V | (2) | : Vertical high-voltage fluctuation compensation amount setting (V SAW output gain control) 0h = 0% (Compensation amount when 1V is applied to ABL IN versus 8V applied to ABL IN) 3h = -7% (Compensation amount when 1V is applied to ABL IN versus 8V applied to ABL IN) |
| INTERLACE | (1) | : Interlace mode and non-interlace display selector switch 0,1h = Interlace mode 2h = Interlace mode; 1/2H shift applied to EVEN lines 3h = Interlace mode; 1/2H shift applied to ODD lines |

- PIN-PHASE** (4) : Horizontal trapezoidal distortion compensation amount adjustment (V parabola wave center timing control)
 0h = 0.8ms advance Horizontal size for top of picture increases; horizontal size for bottom of picture decreases.
 7h = 0ms 8.9ms from 4VDC VTIM
 Fh = 0.8ms delay Horizontal size for top of picture decreases; horizontal size for bottom of picture increases.
- UP-CPIN** (4) : Horizontal pin distortion compensation amount adjustment for top of picture (V parabola wave gain control: Func.)
 0h = +0.6V Horizontal size for top of picture increases. (compensation amount minimum)
 7h = 0V (0.7Vp-p 4:3 mode)
 Fh = -0.6V Horizontal size for top of picture decreases. (compensation amount maximum)
- LO-CPIN** (4) : Horizontal pin distortion compensation amount adjustment for bottom of picture (V parabola wave gain control: Func.)
 0h = +0.5V Horizontal size for bottom of picture increases. (compensation amount minimum)
 7h = 0V (0.7Vp-p 4:3 mode)
 Fh = -0.5V Horizontal size for bottom of picture decreases. (compensation amount maximum)
- V-ASPECT** (6) : Aspect ratio control (Gain control for sawtooth wave)
 0h = 75% 16:9 CRT full
 2Fh = 100% 4:3 CRT full, amplitude: 1.32Vp-p
 3Fh = 112%
- ZOOM SW** (1) : Zoom mode ON/OFF switch for 16:9 CRT (25% of video cut)
 0 = Zoom OFF Sawtooth wave amplitude: 1.32Vp-p
 1 = Zoom ON Sawtooth wave amplitude: 70%
- HBLKSW** (1) : HBLK width control ON/OFF switch during 4:3 software full display mode on a 16:9 CRT
 0 = Control OFF HBLK pulse generated from HPIN.
 1 = Control ON HBLK pulse generated as pulse generated from HPIN or as pulse generated from HVCO and width adjusted.
 Width adjustment is performed by the LEFT-BLK and RIGHT-BLK registers.
- V-SCROLL** (6) : Vertical picture scroll control during zoom mode on a 16:9 CRT (DC component added to sawtooth wave AGC output to control ZOOMSW cut timing.)
 0h = -0.2V Scrolled toward top of screen by 32H and top of picture zoomed.
 1Fh = 0V
 3Fh = +0.2V Scrolled toward bottom of screen by 32H and bottom of picture zoomed.
- JUMPSW** (1) : Reference pulse jump mode ON/OFF switch (In addition to V-ASPECT control, sawtooth wave gain control performed for 100% of VBLK interval and 67% of picture interval)
 0 = Jump mode OFF
 1 = Jump mode ON
 On a 4:3 CRT, jump mode expands the sawtooth wave amplitude to 112% with V-ASPECT; on a 16:9 CRT, jump mode compresses the sawtooth wave amplitude to 75% with V-ASPECT. The V blanking width is expanded at both the top and bottom of the picture. Blanking for the bottom of the picture starts 251H after VTIM, and blanking for the top of the picture can be varied as the blanking width after the reference pulse from the VBLKW register.

- HSIZESW (1) : Lowers the E-W OUT DC level (during H-SIZE compression)
 0 = Normal
 1 = -1.35V
- UP-VLIN (4) : Vertical linearity adjustment for top of picture (Secondary component gain control for sawtooth wave added to sawtooth wave AGC output)
 0h = 100% (Bottom/top of picture)
 Fh = 115% (Bottom/top of picture) Top of picture compressed.
- LO-VLIN (4) : Vertical linearity adjustment for bottom of picture (Tertiary component gain control for sawtooth wave added to sawtooth wave AGC output)
 0h = 100% (Bottom/top of picture)
 Fh = 75% (Bottom/top of picture) Bottom of picture compressed.
- LEFT-BLK (4) : HBLK width control for the left side of picture when HBLKSW = 1 (Phase control for timing pulse generated from HVCO)
 0h = +1.7 μ s HBLK width maximum
 7h = 0 μ s Center HBLK: 15 μ s
 Fh = -1.7 μ s HBLK width minimum
- RIGHT-BLK (4) : HBLK width control for the right side of picture when HBLKSW = 1 (Phase control for timing pulse generated from HVCO)
 0h = +1.7 μ s HBLK width maximum
 7h = 0 μ s Center HBLK: 15 μ s
 Fh = -1.7 μ s HBLK width minimum

6. Other

- AGING (1) : White output aging mode ON/OFF switch
 (Takes priority over RGB ON and PIC ON control. Set to OFF mode at power-on.)
 0 = Aging mode OFF
 1 = Aging mode ON (When there is no input signal, a 60 IRE flat signal is output from the Y block)

7. Status register

| | | |
|-----------|-----|--|
| HLOCK | (1) | : Lock status between H SYNC and H VCO 0 = HVCO free run status 1 = Locked to H SYNC |
| IKR | (1) | : AKB operation status 0 = REF-P at Ik small and AKB loop unstable. 1 = REF-P at Ik sufficient and AKB loop stable. |
| VNG | (1) | : Signal input status to V PROT pin 0 = No V PROT input 1 = V PROT input (In this case, the RGB output is blanked.) |
| XRAY | (1) | : Signal input status to XRAY control pin (HOFF pin) 0 = No XRAY control input 1 = XRAY control input (In this case, the RGB output is blanked.) |
| COLOR SYS | (2) | : Color system status 0h = PAL 1h = NTSC 2h = SECAM 3h = NO STANDARD |
| FSC | (1) | : X'tal status (Fsc information) 0 = 4.43MHz 1 = 3.58MHz |
| FV | (1) | : Vertical deflection frequency status 0 = 50Hz 1 = 60Hz |

Description of Operation

1. Power-on sequence

The CXA2050S does not have an internal power-on sequence. Therefore, power-on sequence is all controlled by the set microcomputer (I²C bus controller).

1) Power-on

The IC is reset and the RGB outputs are all blanked. Hdrive starts to oscillate, but oscillation is at the maximum frequency (16kHz or more) and is not synchronized to the input signal. Output of vertical signal VTIM starts, but Vdrive is DC output. Bus registers which are set by power-on reset are as follows.

| | |
|---------|--|
| AGING | = 0: All white output aging mode OFF |
| RON | = 0: Rch video blanking ON |
| GON | = 0: Gch video blanking ON |
| BON | = 0: Bch video blanking ON |
| PICON | = 0: RGB all blanking ON |
| VOFF | = 1: VDRIVE output stopped mode |
| VFREQ | = 0: Automatic identification mode (identification starts at 50Hz) |
| FHHI | = 1: H oscillator maximum frequency mode |
| HSIZESW | = 0: Normal |
| CD-MODE | = 0: Automatic selector mode of the countdown mode |
| AKBOFF | = 0: AKB mode |

2) Bus register data transfer

The register setting sequence differs according to the set sequence. Register settings for the following sequence are shown as an example.

| Set sequence | CXA2050S register settings |
|---------------------|---|
| Power-on | Reset status in 1) above. |
| ↓ | ↓ |
| Degauss | Reset status in 1) above. The CRT is degaussed in the completely darkened condition. |
| ↓ | ↓ |
| VDRIVE oscillation | The IC is set to the power-on initial settings. (See the following page.) A sawtooth wave is output to VDRIVE and the IC waits for the vertical deflection to stabilize. The HDRIVE oscillator frequency goes to the standard frequency. |
| ↓ | ↓ |
| AKB operation start | PICON is set to 1 and a reference pulse is output from Rout, Gout and Bout. Then, the IC waits for the cathode to warm up and the beam current to start flowing. |
| ↓ | ↓ |
| AKB loop stable | Status register IKR is monitored. IKR = 0: No cathode current IKR = 1: Cathode current Note that the time until IKR returns to 1 differs according to the initial status of the cathode. |
| ↓ | ↓ |
| Video output | RON, GON and BON are set to 1 and the video signal is output from Rout, Gout and Bout. |

I²C bus power-on initial settings

The initial settings listed here for power-on when VDRIVE starts to oscillate are reference values; the actual settings may be determined as needed according to the conditions under which the set is to be used.

Register Table

"*" Undefined

Control Register

| Sub Address | Bit7 | Bit6 | Bit5 | Bit4 | Bit3 | Bit2 | Bit1 | Bit0 |
|---------------|------|------|------|------|------|------|------|------|
| ×××00000 00 h | 1 | 1 | 1 | 1 | 1 | 1 | 0 | 1 |
| ×××00001 01 h | 0 | 1 | 1 | 1 | 1 | 1 | 0 | 1 |
| ×××00010 02 h | 0 | 1 | 1 | 1 | 1 | 1 | 0 | 0 |
| ×××00011 03 h | 0 | 1 | 1 | 1 | 1 | 1 | 1 | 1 |
| ×××00100 04 h | 0 | 1 | 1 | 1 | 0 | 0 | 0 | 0 |
| ×××00101 05 h | 0 | 1 | 1 | 1 | 0 | 1 | 1 | 1 |
| ×××00110 06 h | 0 | 1 | 1 | 1 | 0 | 1 | 1 | 1 |
| ×××00111 07 h | 0 | 1 | 1 | 1 | 1 | 1 | 0 | 0 |
| ×××01000 08 h | 0 | 1 | 1 | 1 | 1 | 1 | 0 | 0 |
| ×××01001 09 h | 0 | 1 | 1 | 1 | 1 | 1 | 0 | 0 |
| ×××01010 0A h | 0 | 1 | 1 | 1 | 0 | 1 | 1 | 1 |
| ×××01011 0B h | 0 | 0 | 0 | 0 | 0 | 0 | 0 | 0 |
| ×××01100 0C h | 0 | 1 | 1 | 1 | 1 | 1 | 0 | 0 |
| ×××01101 0D h | 0 | 1 | 1 | 1 | 1 | 1 | 1 | 0 |
| ×××01110 0E h | 0 | 1 | 1 | 1 | 0 | 1 | 1 | 1 |
| ×××01111 0F h | 0 | 1 | 1 | 1 | 1 | 1 | 0 | 0 |
| ×××10000 10 h | 0 | 1 | 1 | 1 | 1 | 1 | 0 | 0 |
| ×××10001 11 h | 0 | 1 | 1 | 1 | 0 | 1 | 1 | 1 |
| ×××10010 12 h | 0 | 1 | 1 | 1 | 0 | 1 | 1 | 1 |
| ×××10011 13 h | 0 | 0 | 1 | 1 | 0 | 0 | 0 | 0 |
| ×××10100 14 h | 0 | 0 | 0 | 0 | 0 | 0 | 1 | 1 |
| ×××10101 15 h | 0 | 1 | 1 | 1 | 1 | 1 | 0 | 0 |
| ×××10110 16 h | 0 | 1 | 1 | 1 | 0 | 1 | 1 | 1 |
| ×××10111 17 h | 0 | 1 | 1 | 1 | 1 | 1 | 1 | 1 |
| ×××11000 18 h | 0 | 1 | 1 | 1 | 0 | 1 | 1 | 1 |
| ×××11001 19 h | 0 | 1 | * | * | 0 | 0 | 1 | 1 |

3) Power-on initial settings

The initial settings listed here for power-on when VDRIVE starts to oscillate are reference values; the actual settings may be determined as needed according to the conditions under which the set is to be used.

| | | |
|------------|-------|--|
| PICTURE | = 3Fh | Max. (User Control) |
| TRAP OFF | = 0 | Chroma Trap ON |
| VM | = 1 | 2.65Vp-p (User Control) |
| HUE | = 1Fh | Center (User Control) |
| DC-TRAN | = 0 | Y DC transmission ratio 100% |
| D-PIC | = 1 | Y black expansion ON |
| COLOR | = 1Fh | Center (User Control) |
| TOT | = 0 | Chroma low frequency increased |
| ABL | = 0 | Picture/Bright ABL mode |
| BRIGHT | = 1Fh | Center (User Control) |
| D-COL | = 1 | Dynamic Color ON |
| LIMIT | = 1 | Peak Limiter ON |
| SHARPNESS | = 7h | Center (User Control) |
| PRE-OVER | = 0 | Sharpness pre/over ratio 1:1 |
| COLOR SW | = 0 | AUTO |
| SUB-CONT | = 7h | Center (Adjust) |
| TRAP F0 | = 7h | Center (Adjust) |
| SUB-COLOR | = 7h | Center (Adjust) |
| SUB-HUE | = 7h | Center (Adjust) |
| SUB-BRIGHT | = 1Fh | Center (Adjust) |
| GAMMA | = 0 | Gamma OFF |
| G-DRIVE | = 1Fh | Center (Adjust) |
| AGING | = 0 | Aging Mode OFF |
| B-DRIVE | = 1Fh | Center (Adjust) |
| INTERLACE | = 0 | INTERLACE mode |
| G-CUTOFF | = 7h | Center (Adjust) |
| B-CUTOFF | = 7h | Center (Adjust) |
| RON | = 0 | Rch video output OFF |
| GON | = 0 | Gch video output OFF |
| BON | = 0 | Bch video output OFF |
| PICON | = 0 | RGB all blanked |
| VOFF | = 0 | Vdrive oscillation |
| FHHI | = 0 | Horizontal oscillator frequency standard |
| CD-MODE | = 0 | V countdown auto mode |
| AKBOFF | = 0 | AKB ON |
| V-SIZE | = 1Fh | Center (Adjust) |
| V-FREQ | = 0 | AUTO |
| V-POSITION | = 1Fh | Center (Adjust) |
| AFC-MODE | = 2 | Center |
| S-CORR | = 7h | Center (Adjust) |
| V-LIN | = 7h | Center (Adjust) |
| H-SIZE | = 1Fh | Center (Adjust) |
| REF-POSI | = 0 | |
| PIN-COMP | = 1Fh | Center (Adjust) |

(Power-on initial settings cont.)

| | | |
|------------|-------|--|
| H-POSITION | = 7h | Center (Adjust) |
| PIN-PHASE | = 7h | Center (Adjust) |
| AFC-BOW | = 7h | Center (Adjust) |
| AFC-ANGLE | = 7h | Center (Adjust) |
| EHT-H | = 0 | H drive high-voltage compensation OFF |
| EHT-V | = 3 | V drive high-voltage compensation amount maximum |
| XTAL | = 0 | AUTO |
| EXT SYNC | = 0 | Internal SYNC |
| CV/YC | = 0 | CV input |
| V-ASPECT | = 0h | 16:9 CRT Full Mode |
| ZOOMSW | = 1 | 16:9 CRT |
| HBLKSW | = 1 | Hblk width adjust ON |
| V-SCROLL | = 1Fh | Center (User Control) |
| JMP5W | = 0 | 16:9 CRT Full Mode |
| HSIZE SW | = 0 | Normal |
| UP-VLIN | = 7h | 16:9 CRT Full Mode |
| LO-VLIN | = 7h | 16:9 CRT Full Mode |
| LEFT-BLK | = Fh | Hblk width Min. (Adjust) |
| RIGHT-BLK | = Fh | Hblk width Min. (Adjust) |
| UP-CPIN | = 7h | Center (Adjust) |
| LO-CPIN | = 7h | Center (Adjust) |
| CDMODE2 | = 0 | Standard |
| SHPF0 | = 1 | Sharpness F0 3.5MHz |
| YS1 OFF | = 0 | Normal |
| DL | = 3 | Normal (Adjust) |

2. Various mode settings

The CXA2050S contains bus registers for deflection compensation which can be set for various wide modes. Wide mode setting registers can be used separately from registers for normal picture distortion adjustment, and once deflection adjustment has been performed in full mode, wide mode settings can be made simply by changing the corresponding register data.

- VDRIVE signal picture distortion adjustment registers
V-SIZE, V-POSITION, S-CORR, V-LIN
- E/WDRIVE signal picture distortion adjustment registers
H-SIZE, PIN-COMP, PIN-PHASE, UP-CPIN, LO-CPIN
- Wide mode setting registers
V-ASPECT, ZOOMSW, HBLKSW, V-SCROLL, JMP5W, HSIZESW, UP-VLIN, LO-VLIN, LEFT-BLK, RIGHT-BLK

Examples of various modes are listed below. These modes are described using 570 (NTSC: 480) lines as the essential number of display scanning lines. Wide mode setting register data is also listed, but settings may differ slightly due to IC variation. The standard setting data differs for 16:9 CRTs and 4:3 CRTs.

| Register | 16:9 CRT | 4:3 CRT |
|-----------|----------|---------|
| V-ASPECT | 0h | 2Fh |
| V-SCROLL | 1Fh | 1Fh |
| ZOOMSW | 1 | 0 |
| UP-VLIN | 0h | 0h |
| LO-VLIN | 0h | 0h |
| JMP SW | 0 | 0 |
| HSIZESW | 0 | 0 |
| HBLKSW | 1 | 1 |
| LEFT-BLK | 7h | 7 |
| RIGHT-BLK | 7h | 7h |

1) 16:9 CRT full mode

This mode reproduces the full 570 (NTSC:480) lines on a 16:9 CRT. 4:3 images are reproduced by stretching the picture to the left and right.

Normal images are compressed vertically, but 16:9 images can be reproduced in their original 16:9 aspect ratio with a video source which compresses (squeezes) 16:9 images to 4:3 images. The register settings are the 16:9 CRT standard values.

2) 16:9 CRT normal mode

In this mode, 4:3 images are reproduced without modification. A black border appears at the left and right of the picture. In this mode, the H deflection size must be compressed by 25% compared to full mode. The CXA2050S permits compression with a register (HSIZESW) that compresses the H size by 25%. Because excessive current flows to the horizontal deflection coil in this case, adequate consideration must be given to the allowable power dissipation, etc., of the horizontal deflection coil in the design of the set. In addition, this concern can also be addressed through measures taken external to the IC, such as by switching the horizontal deflection coil. Full mode should be used when using memory processing to add a black border to the video signal.

H blanking of the image normally uses the flyback pulse input to AFCPIN (Pin 44). However, the blanking width can be varied according to the control register setting when blanking is insufficient for the right and left black borders.

The following three settings are added to the 16:9 CRT standard values for the register settings.

HBLKSW = 1
 LEFT-BLK = Adjustment value
 RIGHT-BLK = Adjustment value

The H angle of deflection also decreases, causing it to differ from the PIN compensation amount during H size full status. Therefore, in addition to the wide mode registers, PIN-COMP must also be readjusted only for this mode.

3) 16:9 CRT zoom mode

In this mode, 4:3 images are reproduced by enlarging the picture without other modification. The top and bottom of normal 4:3 images are lost, but almost the entire picture can be reproduced for vista size video software, etc. which already has black borders at the top and bottom. The enlargement ratio can be controlled by the V-ASPECT register, and enlarging the picture by 33% compared to full mode allows zooming to be performed for 4:3 images without distortion. In this case, the number of scanning lines is reduced to 430 lines compared to 570 lines for full mode. The zooming position can be shifted vertically by the V-SCROLL register. V blanking of the image normally begins from V sync and continues for 2H after the AKB reference pulse, and the top and bottom parts are also blanked during this mode.

Adjust the following two registers with respect to the 16:9 CRT standard values for the register settings.

V-ASPECT = 2Fh
 V-SCROLL = 1Fh or user control

4) 16:9 CRT subtitle-in mode

When CinemaScope size images which have black borders at the top and bottom of the picture are merely enlarged with the zoom mode in 3) above, subtitles present in the black borders may be lost. Therefore, this mode is used to super-compress only the subtitle part and reproduce it on the display.

Add the LO-VLIN adjustment to the zoom mode settings for the register settings.

V-ASPECT = 2Fh

V-SCROLL = 1Fh or user control

LO-VLIN = Adjustment value

The LO-VLIN register causes only the linearity at the bottom of the picture to deteriorate. Therefore, UP-VLIN should also be adjusted if the top and bottom of the picture are to be made symmetrical. Since the picture is compressed vertically, the number of scanning lines exceeds 430 lines.

5) 16:9 CRT V compression mode

This mode is used to reproduce two 4:3 video displays such as for PandP. The V size must be compressed to 67% in order to reproduce two displays on a 16:9 CRT without distortion using 480 scanning lines, and this can be set by JMPSW. Compression is performed after the AKB reference pulse, so the reference pulse remains in the overscan position. The V blanking width after the reference pulse becomes larger than normal and can be varied by the VBLKW register. During this mode, the bottom V blanking width is also expanded to 3H wider than normal so that the bottom of the picture is not overscanned.

16:9 CRT standard values are used with only the JMPSW setting changed for the register settings.

JMPSW = 1

6) 16:9 CRT wide zoom mode

This mode reproduces 4:3 video software naturally on wide displays by enlarging 4:3 images without other modification and compressing the parts of the image which protrude from the picture into the top and bottom parts of the picture. The display enlargement ratio is controlled by V-ASPECT, and the compression ratios at the top and bottom of the picture are controlled by UP-VLIN and LO-VLIN.

Adjust the following three registers with respect to the 16:9 CRT standard values for the register settings.

V-ASPECT = Adjustment value

UP-VLIN = Adjustment value

LO-VLIN = Adjustment value

7) 4:3 CRT normal mode

This is the standard mode for 4:3 CRTs.

The register settings are the 4:3 CRT standard values.

8) 4:3 CRT V compression mode

This mode is used to reproduce M-N converter output consisting of 16:9 images expanded to a 4:3 aspect ratio and other squeezed signals without distortion on a 4:3 CRT. The V size must be compressed to 75% in order to reproduce a 4:3 squeezed signal at a 16:9 aspect ratio without any distortion. Compressing the V size with the JMPSW register used in mode 5) above, compresses the V size to 67%. Therefore, V-ASPECT is set to enlarge the V size by 8%. AKB reference pulse handling and V blanking are the same as for mode 5) above.

4:3 CRT standard values are used with the V-ASPECT and JMPSW settings changed for the register settings.

V-ASPECT = 3Fh

JMPSW = 1

Mode Settings

| Setting | CRT SIZE | SOFT SIZE | MODE NAME | I ² C BUS REGISTER |
|---------|----------|-------------------------------------|-----------------------------------|--|
| 1)-1 | 16:9 | 16:9 | 16:9 CRT full | V-ASPECT = 0h: V size 75% |
| 1)-2 | 16:9 | 4:3 | Wide full | V-ASPECT = 0h: V size 75% |
| 2) | 16:9 | 4:3 | 16:9 CRT normal | V-ASPECT = 0h: V size 75% HBLKSW = 1h: HBLK width adjustment ON LEFT-BLK = Adjustable RIGHT-BLK = Adjustable PIN-COMP = Adjustable (External support: H-DY H amplitude 75%) |
| 3) | 16:9 | 4:3 | 16:9 CRT zoom | V-ASPECT = 2Fh: V size 100% ZOOMSW = 1h: Zoom ON V size limited at 75% V-SCROLL = 0h: Zoom bottom of video image 1Fh: Zoom center of video image 3Fh: Zoom top of video image Adjustable: Open to user |
| 4) | 16:9 | 4:3 (16:9 + subtitle area) | 16:9 CRT with subtitle area on | V-ASPECT = 2Fh: V size 100% UP-VLIN = Adjustable: Slightly compresses top of video image LO-VLIN = Adjustable: Significantly compresses bottom of video image ZOOMSW 1h: V size limited at 75% (V-SCROLL = Adjustable) |
| 5) | 16:9 | 4:3 | 16:9 CRT V compression | V-ASPECT = 0h: V size 75% JMPSW = 1h: Reference pulse skipping ON V size compressed 67% after the reference pulse (compressed to 50% total) VBLKW = Adjustable: VBLK width expanded at top and bottom of video image |
| 6) | 16:9 | 4:3 | 16:9 CRT wide zoom | V-ASPECT = Adjustable: V size 90% UP-VLIN = Adjustable: LO-VLIN = Adjustable: } Compression of top and (S-CORR = Adjustable): } bottom of video image |
| 7) | 4:3 | 4:3 | 4:3 CRT normal | V-ASPECT = 2Fh: V size 100% |
| 8) | 4:3 | 16:9 | 4:3 CRT V compression | V-ASPECT = 3Fh: V size 112% JMPSW = 1h: Reference pulse skipping ON (compressed to 75% total) VBLKW = Adjustable: VBLK width expanded at top and bottom of video image |

* The amount of picture distortion compensation in a vertical direction position of the CRT does not change in response to the above modes; as a result, the initial values of each picture distortion register can be used as it is.

3. Signal processing

The CXA2050S is comprised of sync signal processing, H deflection signal processing, V deflection signal processing, and Y/C/RGB signal processing blocks, all of which are controlled by the I²C bus.

1) Sync signal processing

Pin 54 (SYNC OUT) outputs at 2Vp-p either the internal signal (CVIN/YIN) selected by the internal video switch, or the external sync signal input from Pin 63 (EXT SYNC IN).

This selection is controlled by the I²C bus. The signal output from Pin 54 is buffered by a PNP Tr. and is then input to HSIN (Pin 53) or VSIN (Pin 52) through a suitable filter.

The Y signals input to Pins 52 and 53 are sync separated by the horizontal and vertical sync separation circuits. The resulting horizontal sync signal and the signal (FH = 15625Hz or 15734Hz) obtained by frequency dividing the 32FH-VCO output using the ceramic oscillator (frequency 500kHz or 503.5kHz) by 32 are phase-compared, the AFC loop is constructed, and an H pulse synchronized with the H sync is generated inside the IC. Adjustment of the H oscillator frequency is unnecessary. When the AFC is locked to the H sync, 1 is output to the status register (HLOCK) and that can be used to detect the presence of the video signal.

The vertical sync signal is sent to the V countdown block where the most appropriate window processing is performed to obtain V sync timing information which resets the counter. AKB and other V cycle timing are then generated from this reset timing.

2) H deflection signal processing

The H pulse obtained through sync processing is phase-compared with the H deflection pulse input from Pin 44 to control the phase of the HDRIVE output and the horizontal position of the image projected on the CRT. In addition, the compensation signal generated from the V sawtooth wave is superimposed, and the vertical picture distortion is compensated.

The H deflection pulse is used to H blanking of the video signal. When the pulse input from Pin 44 has a narrow width, the pulse generated by the IC can be added to the H deflection pulse and used as the H blanking pulse (HBLKSW).

Pin 44 is normally pulse input, but if the pin voltage drops to the GND level, HDRIVE output stops and 1 is output to the status register (XRAY). To release this status, turn the power off and then on again.

3) V deflection signal processing

The V sawtooth wave is generated at the cycle of the reset pulse output from the countdown system. After performing wide deflection processing for this sawtooth wave, picture distortion adjustment is performed by the VDRIVE and E/WDRIVE function circuits and the signal is output as the VDRIVE and E/WDRIVE signals.

4) Y signal processing

Either CVIN, input from Pin 60, or YIN, output from Pin 62, is selected by the video switch and then is passed to the Y signal processing circuit as the Y signal. The input level is 1Vp-p.

The Y signal passes through the subcontrast control, the trap for eliminating the chroma signal, the delay line, the sharpness control, the clamp and the black expansion circuits, and is then output to Pin 11 as YOUT. The differential waveform of the Y signal, advanced for about 200ns from YOUT is output from Pin 55 as the VM signal. The delay time is set by the bus register (DL).

When CVIN is selected, the trap is on; when YIN is selected, the trap is off.

The f₀ of the internal filter is automatically adjusted within the IC. When the color killer function is operating, the f₀ of the filter is not specified and rolling of display is generated. And, when status register COLOR SYS is not standard, turn the trap off. In addition, the f₀ of the trap will be affected slightly by variations among IC, so fine adjustment through the I²C bus (TRAP-F0) may be required.

5) C signal processing

The CVBS signal or chroma signal (specified input level: burst level of 300mVp-p) selected by the video switch passes through the ACC, TOT, chroma amplifier and demodulation circuits, becomes the R-Y and B-Y color difference signals, and is inverted for output on Pins 9 and 10. The color difference signals are averaged together by the external 1H delay line, and are input to Pins 14 and 15. Both color difference signals are clamped together with the Y signal input to Pin 13. They are then combined with the G-Y signal in the color control and axis control circuits. After Y/C mixing, the signals become the RGB signals.

If the burst level goes to -37dB or less with respect to the specified input level, the color killer operates.

In addition, the color system (PAL/NTSC) and the subcarrier frequency (4.43MHz/3.58MHz) are automatically identified according to the input chroma signal, and the internal VCO, demodulation circuit, axis control circuit, etc., are adjusted automatically.

Furthermore, SECAM signals can also be identified if an external SECAM decoder is connected to Pin 7. In this case, Pins 9 and 10 and the SECAM decoder color difference output are linked together directly, and automatically one side goes to high impedance, the other goes to low impedance according to the input chroma signal, and then they are input to the external 1H delay line.

System identification can be set to automatic or forced mode by the I²C bus (XTAL and COLOR SW). For identification result, the X'tal status selected as color system is output to the status registers (COLOR SYS and FSC).

6) RGB signal processing

The RGB signals obtained from the Y/C block pass through the half-tone switch circuit (YM SW), the two switch circuits for the external RGB signals (YS1, YS2 SW), the picture control, dynamic color, gamma compensation, clamp, brightness control, drive adjustment, cut-off adjustment and auto cut-off circuits, and are output to Pins 28, 30 and 32.

The RGB signals input to Pins 18, 19, 20, 23, 24, and 25 are 100 IRE, 100% white 0.7Vp-p signals, in accordance with the standard for normal video signals. If signals of 1.5Vp-p or more are input to Pins 23, 24, and 25, 78 IRE output is obtained (digital input).

The voltage applied to Pin 34 (ABLIN) is compared with the internal reference voltage, integrated by the capacitor which is connected to Pin 35, and performs picture control and brightness control.

In order to adjust the white balance (black balance), this IC has a drive control function which adjusts the gain between the RGB outputs and a cut-off control function which adjusts the DC level between the RGB outputs. Both drive control and cut-off control are adjusted by the I²C bus, with the Rch fixed and the G and Bch variable. An auto cut-off function (AKB) which forms a loop between the IC and CRT and performs adjustment automatically has also been added. This function can compensate for changes in the CRT with time. Auto cut-off operation is as follows.

- R, G and B reference pulses for auto cut-off, shifted 1H each in the order mentioned, appear at the top of the picture (actually, in the overscan portion). The reference pulse uses 1H in the V blanking interval, and is output from each R, G and B output pin.
- The cathode current (Ik) of each R, G and B output is converted to a voltage and input to Pin 33.
- The voltage input to Pin 33 is compared with the reference voltage in the IC, and the current generated by the resulting error voltage charges the capacitors connected to Pins 27, 29 and 31 for the reference pulse interval and is held during all other interval.
- The loop functions to change the DC level of the R, G and B outputs in accordance with the capacitor pin voltage so that the Pin 33 voltage matches the reference voltage in the IC.

The Rch for the reference voltage in the IC is fixed and the G and Bch are cut-off controlled by the I²C bus. During G/B-CUTOFF center status, the loop functions so that the Rch for the reference pulse input to Pin 33 is 1Vp-p and the G and Bch are 0.81Vp-p.

The reference pulse timing can be varied by the I²C bus.

When AKB is not used, the IC can be set to manual cut-off mode with I²C bus settings. In this case, the DC level of the R, G and B outputs can be varied by applying voltages independently to Pins 27, 29 and 31.

4. Notes on operation

Because the RGB signals and deflection signals output from the CXA2050S are DC direct connected, the board pattern must be designed consideration given to minimizing interference from around the power supply and GND.

Do not separate the GND patterns for each pin; a solid earth is ideal. Design power supply as low impedance as possible. when impedance of power supply is high, video block power supply V_{cc} interferes with deflection block power supply DV_{cc} , and its deflection operation may be unstable. For this countermeasure, inputting LC to each SV_{cc} and DV_{cc} stabilizes the operation because power supply's interference is reduced. Locate the power supply side of the by-pass capacitor which is inserted between the power supply and GND as near to the pin as possible. Also, locate the XTAL oscillator, ceramic oscillator and IREF resistor as near to the pin as possible, and do not wire signal lines near this pin. Drive the Y, external Y/color difference and external RGB signals at a sufficiently low impedance, as these signals are clamped when they are input using the capacitor connected to the input pin.

DC bias is applied to the chroma signal within the IC. Input the chroma signal with low impedance via an external capacitor.

Use a resistor (such as a metal film resistor) with an error of less than 1% for the IREF pin.

Use a capacitor, such as an MPS (metalized polyester capacitor) with a small $\tan \delta$ for SAWOSC.

When using a line frequency FH of 15625Hz for the main clock (PAL-B, G, etc.), Murata's Ceralock CSB500F63 is recommended. This will yield a free-running frequency in the neighborhood of 15625Hz.

Curve Data

I²C bus data conforms to the "I²C Bus Register Initial Settings" of the Electrical Characteristics Measurement Conditions (P. 22).

V-SIZE

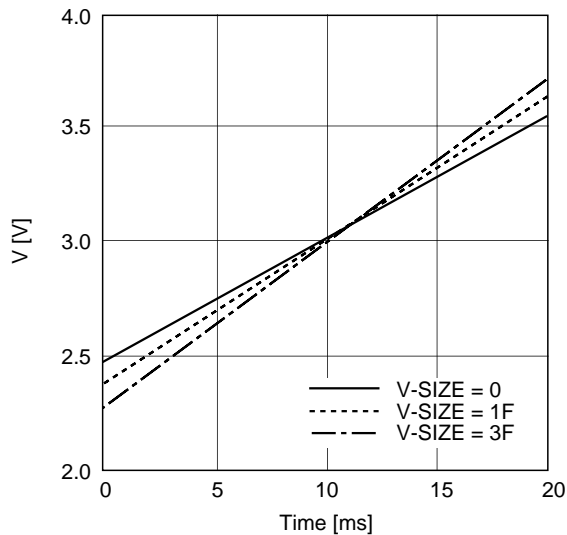

V-POSITION

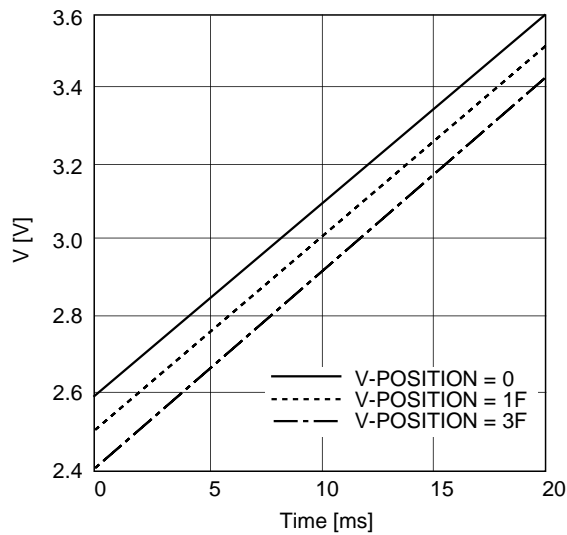

S-CORR

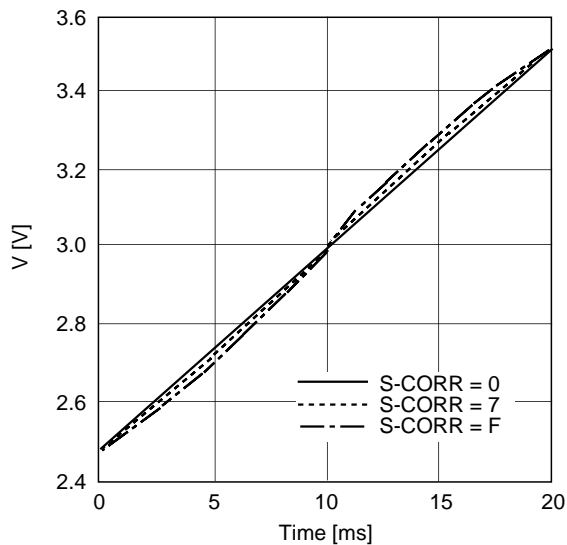

V-LIN

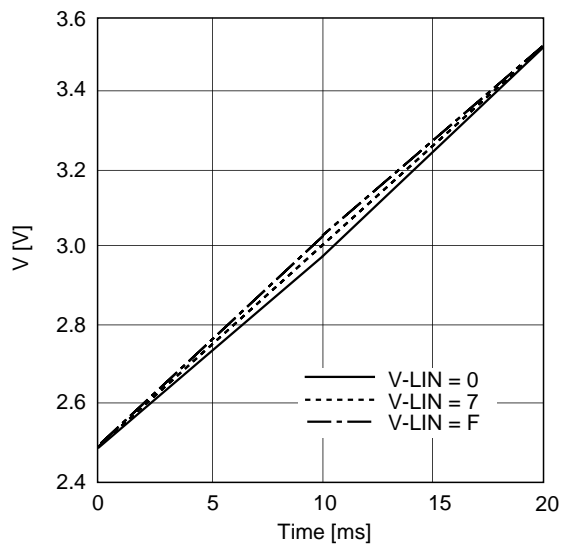

V-ASPECT

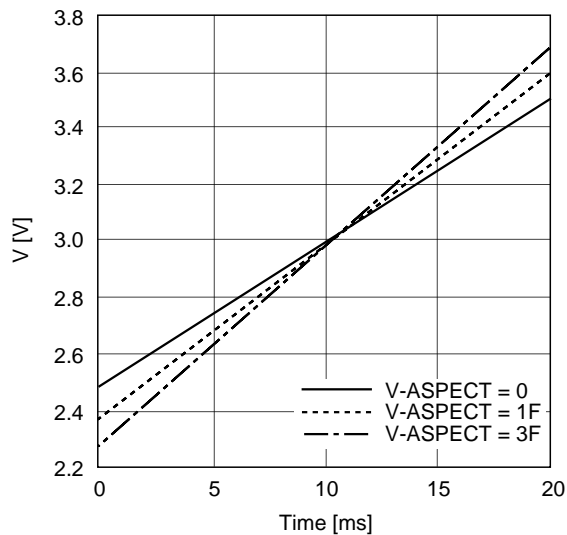

V-SCROLL

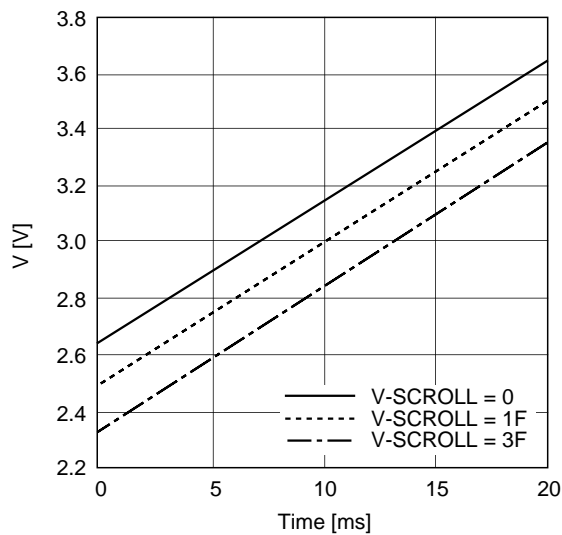

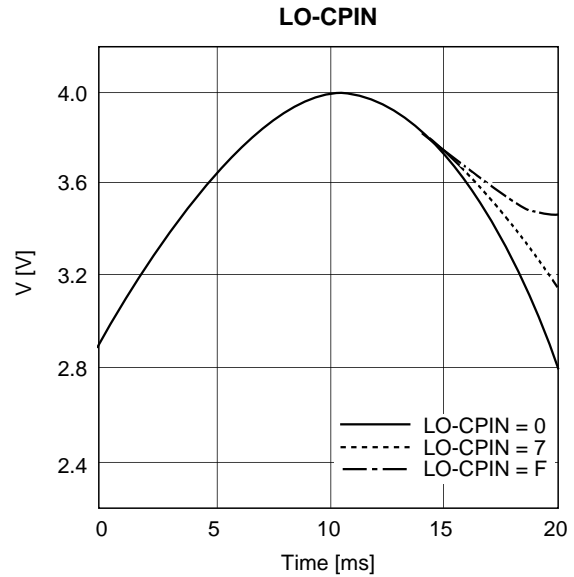
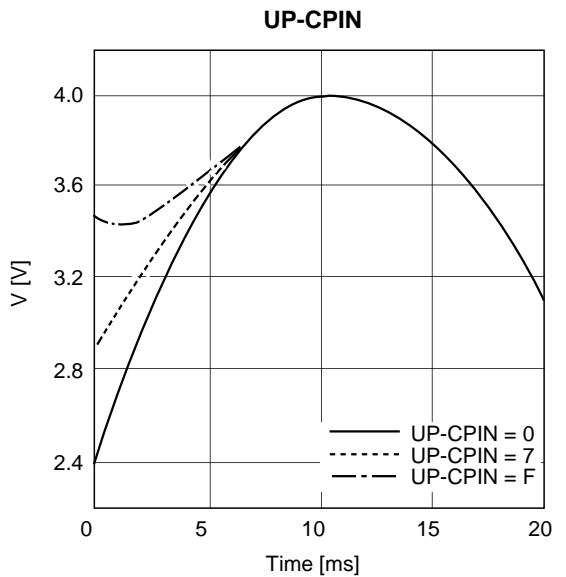
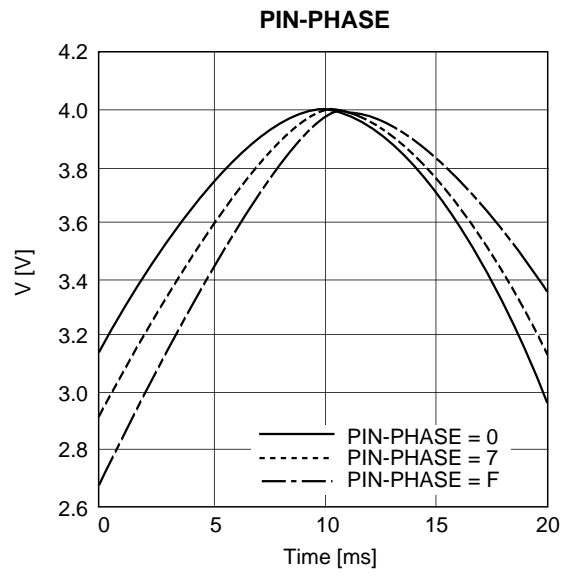
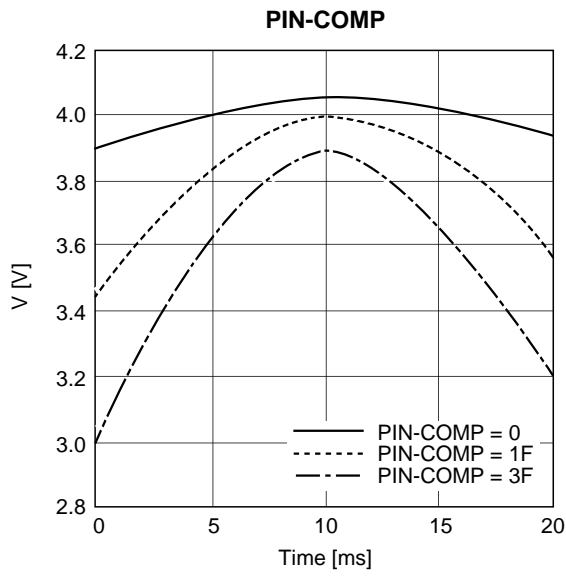
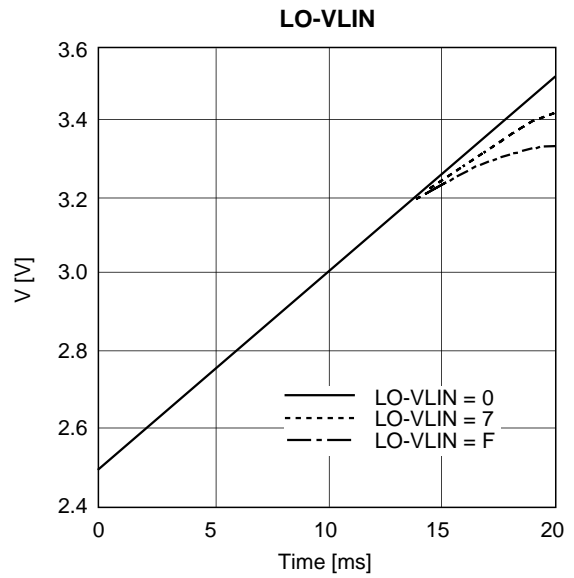
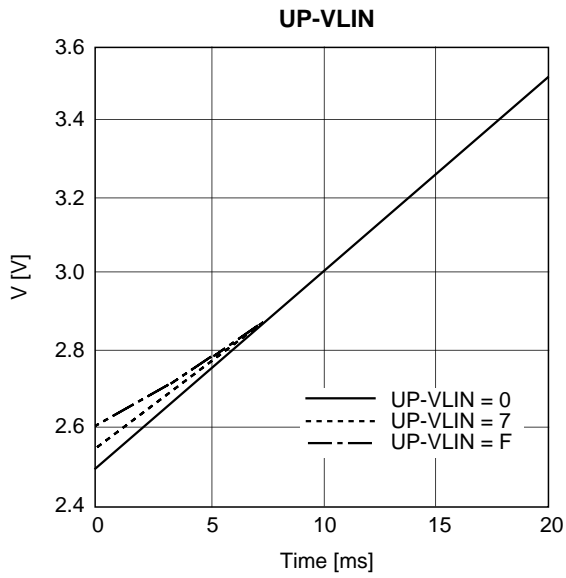

H-SIZE

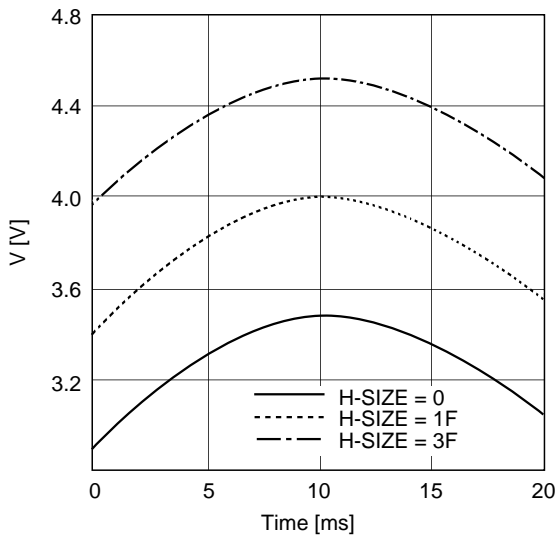

H-POSITION

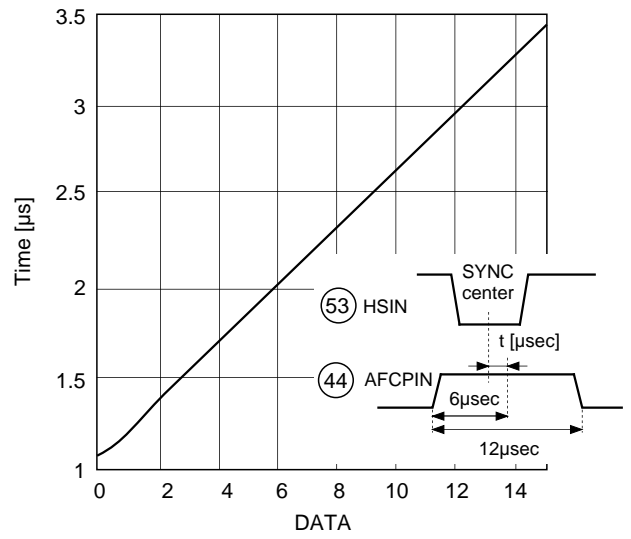

TRAP OFF

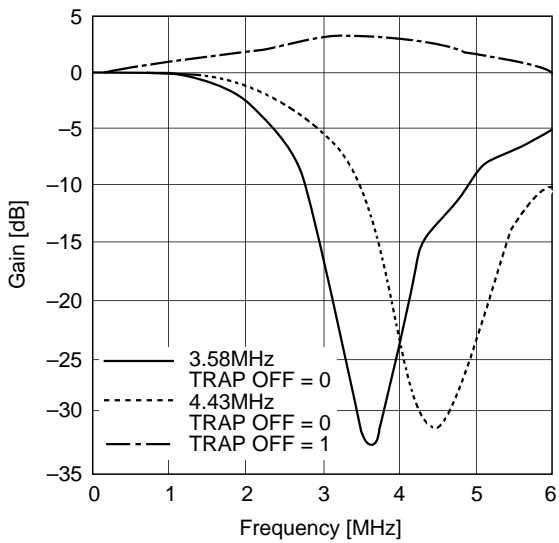

DELAY

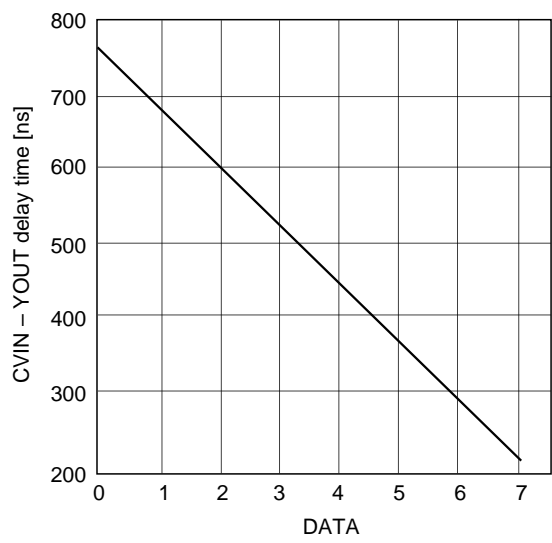

SHARPNESS (SHP F0 = 0)

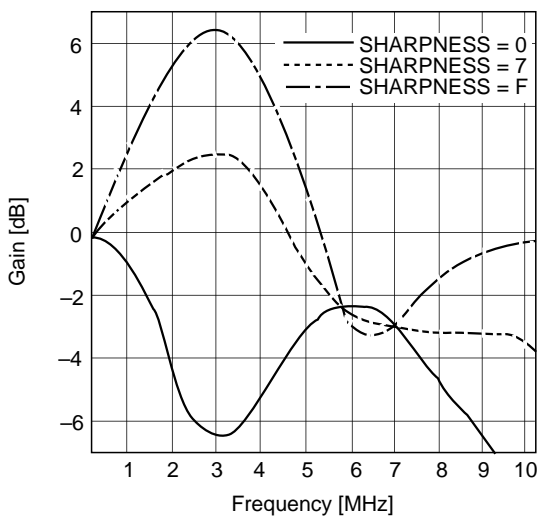

SHARPNESS (SHP F0 = 1)

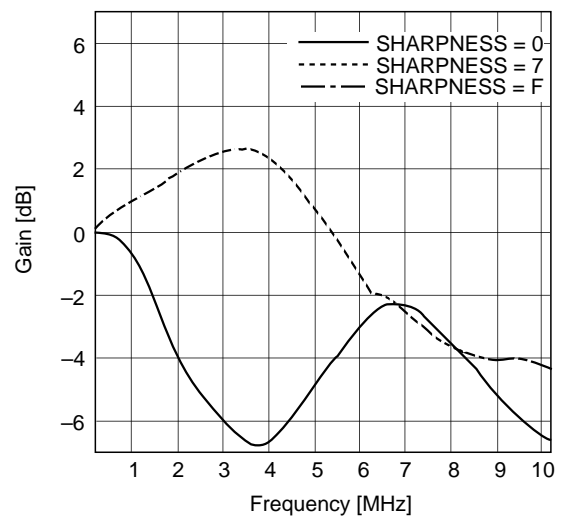

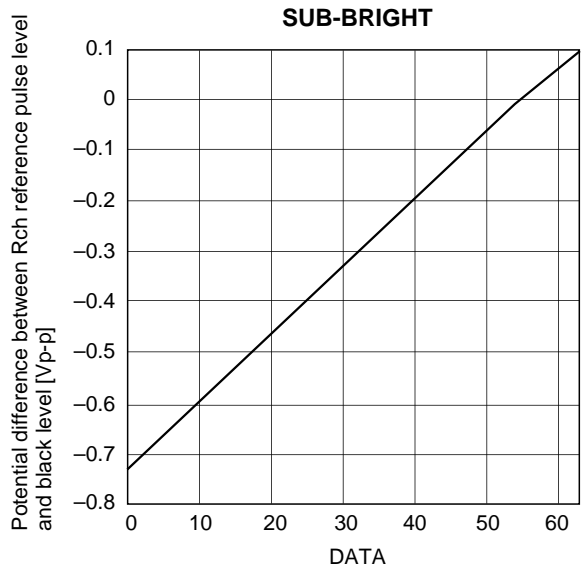
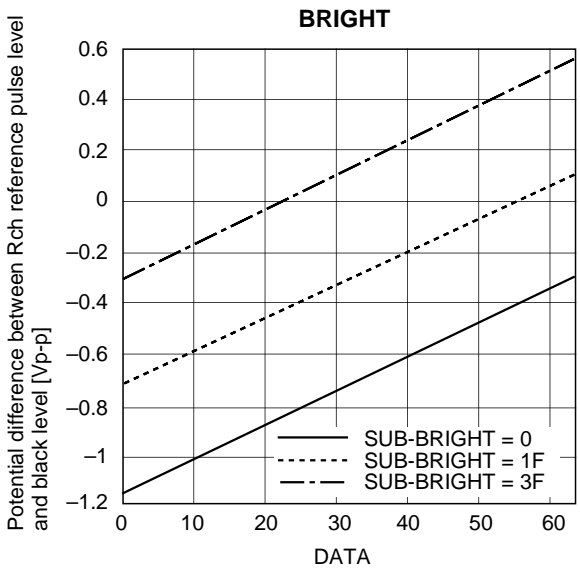
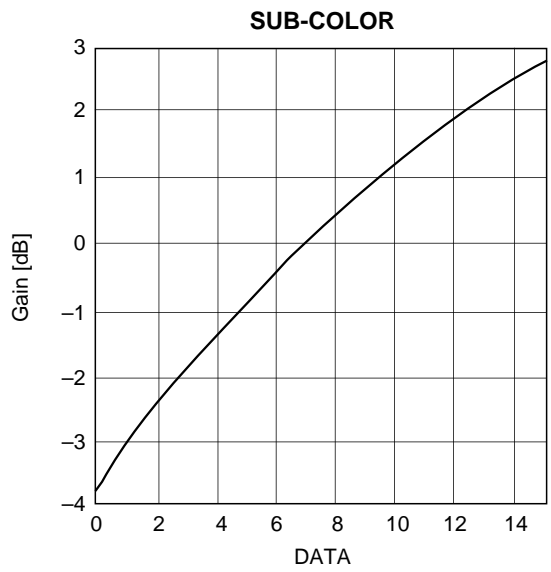
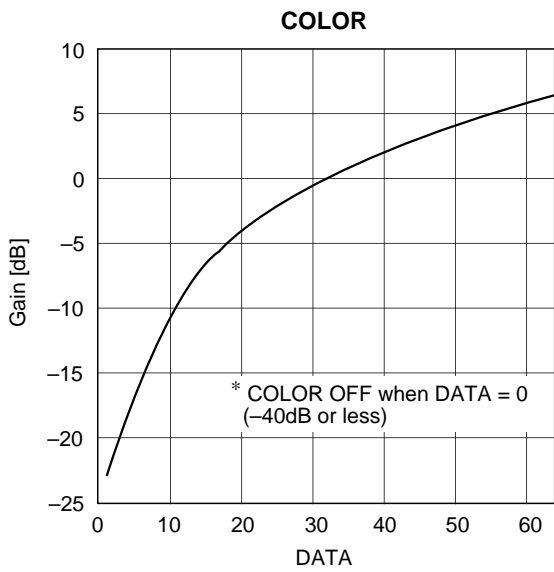
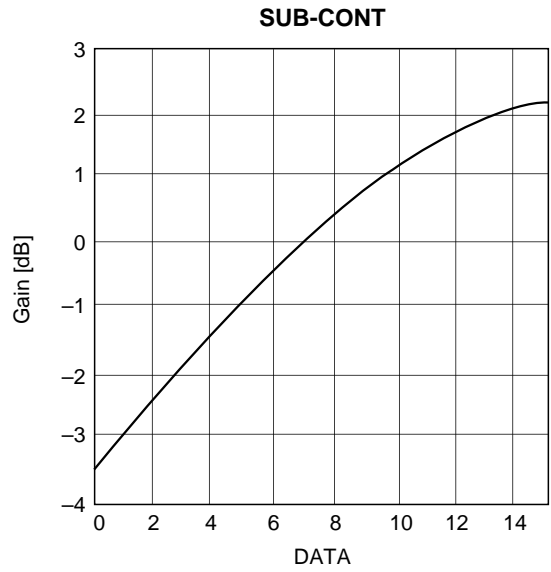
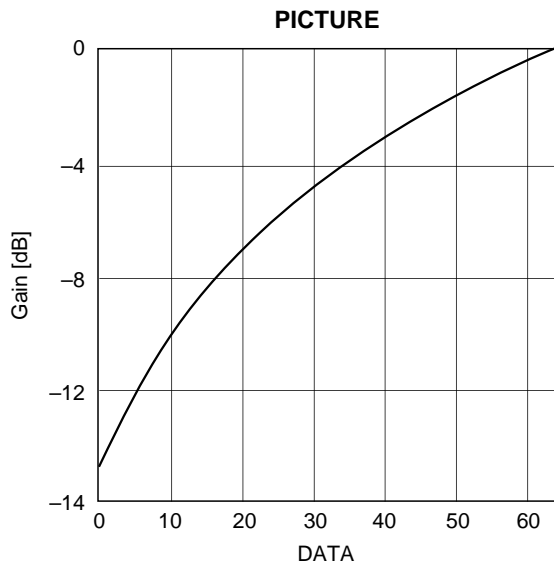

B-DRIVE, G-DRIVE

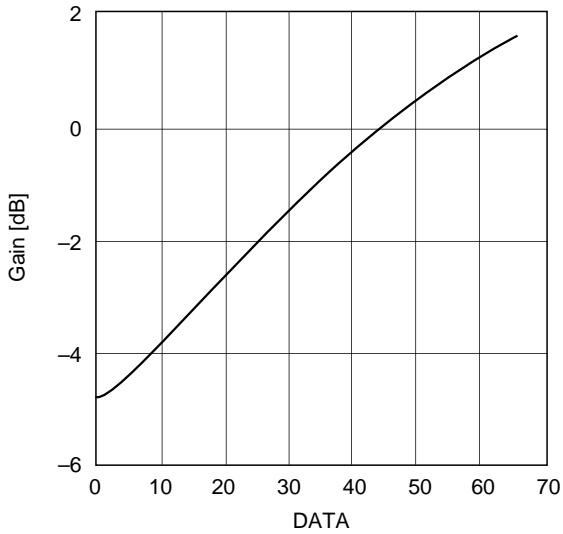

GAMMA

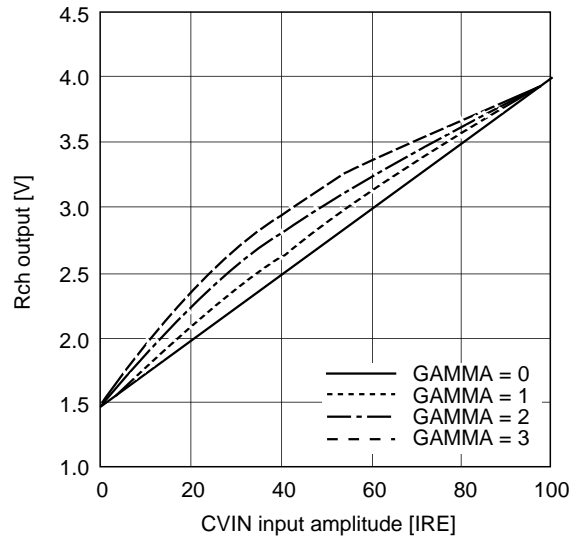

G-CUTOFF, B-CUTOFF

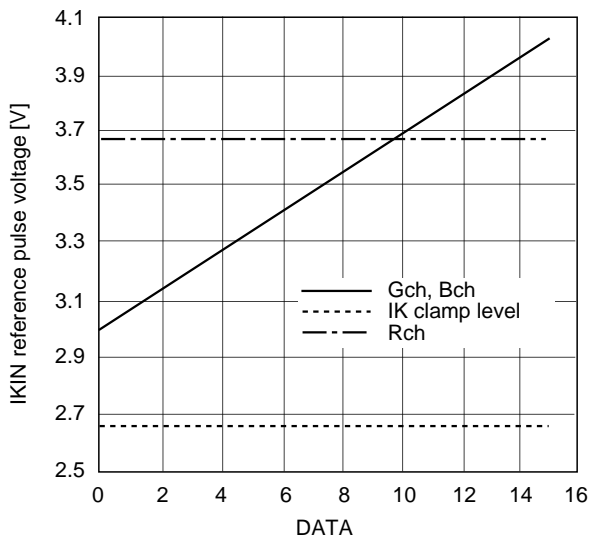

AKB open loop characteristics

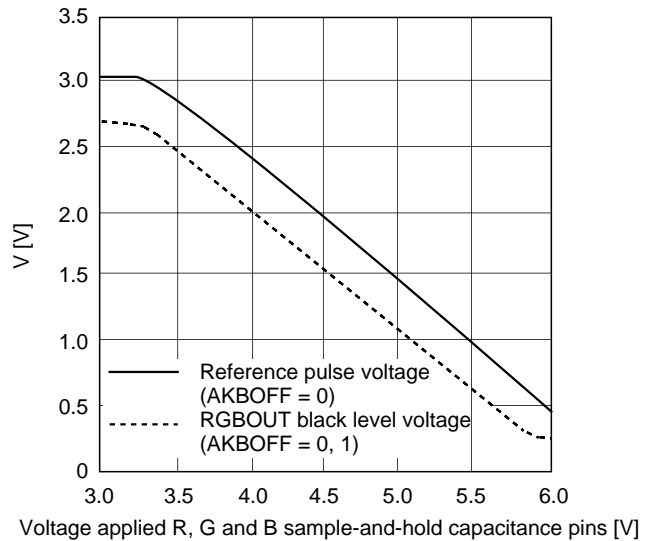

Package Outline Unit: mm

64PIN SDIP (PLASTIC)

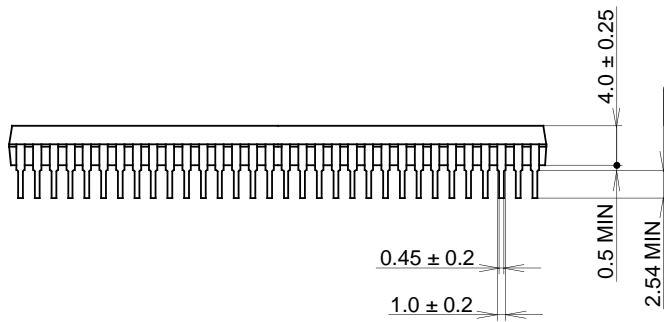
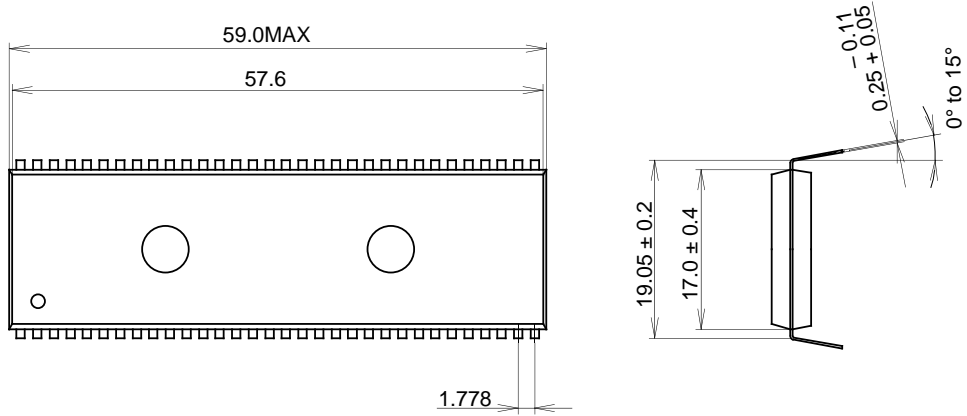

PACKAGE STRUCTURE

| | |
|------------|----------------|
| SONY CODE | SDIP-64P-051 |
| EIAJ CODE | SDIP064-P-0750 |
| JEDEC CODE | _____ |

| | |
|------------------|----------------|
| PACKAGE MATERIAL | EPOXY RESIN |
| LEAD TREATMENT | SOLDER PLATING |
| LEAD MATERIAL | COPPER ALLOY |
| PACKAGE WEIGHT | 9.0g |