

- ◆ Ceramic Capacitors Compatible
- ◆ Input Voltage Range: 0.9V~10.0V
- ◆ Output Voltage Externally Set-up
- ◆ Oscillation Frequency: 300kHz, 180kHz (±15%)
- ◆ PWM Control (XC9103)
 - PWM/PFM Automatic Switching Control (XC9104)
 - PWM/PFM Manual Switching Control (XC9105)
- ◆ SOT-25 / USP-6B Package

■ GENERAL DESCRIPTION

The XC9103/9104/9105 series are PWM, PWM/PFM auto switching /manual switching controlled multi-functional step-up DC/DC converter controllers.

Output will be stable no matter which load capacitors are used but should a low ESR capacitor be used, RSENSE of about 0.1Ω will be required and phase compensation will be achieved. This makes the use of ceramic capacitors much easier and allows for lower output ripple and reduced PCB area requirements. Tantalum and electrolytic capacitors can also be used, in which case, RSENSE becomes unnecessary.

With 0.9V of standard voltage supply internal, and using externally connected components, output voltage can be set up freely within a range of 1.5V to 30V. With 300kHz or 180kHz frequencies, the size of the external components can be reduced. Oscillation frequencies of 100kHz and 500kHz are also available as custom-designed products.

The XC9103 series are PWM controlled. Control switches from PWM to PFM during light loads with the XC9104 and the series is highly efficient from light loads to large output currents. By using external signals, control of the XC9105 can be alternated between PWM and PWM/PFM automatic switching and so, control suited to the application can be selected.

A current limiter circuit is built in to the IC (except with the 100kHz and 500kHz version) and monitors the ripple voltage on the FB pin. Operation is shut down when the ripple voltage is more than 250mV(180kHz version). The operations of the IC can be returned to normal with a toggle of the CE pin or by turning the power supply back on.

■ TYPICAL APPLICATION CIRCUIT

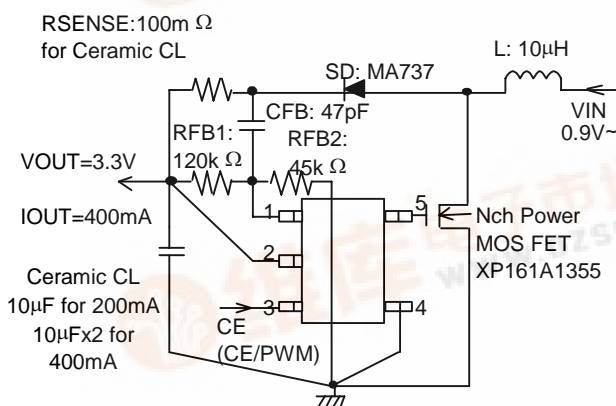

■ APPLICATIONS

- PDAs
- Cellular Phones
- Palmtop Computers
- Portable Audio Systems
- Various Multi-function Power Supplies

■ FEATURES

Input Voltage Range:	0.9V ~ 10V
Power Supply Voltage Range:	1.8V ~ 10V
Output Voltage Range:	1.5V ~ 30V
	Set up freely with a standard voltage supply of 0.9V (±2.0%) & external components
Oscillation Frequency:	300, 180kHz ±15%
	100, 500kHz available as semi-custom
Output Current:	more than 400mA
	(VIN=1.8V, VOUT=3.3V)
Controls:	PWM (XC9103)
	PWM/PFM auto-switching (XC9104)
	PWM/PFM manual switching (XC9105)
High Efficiency:	85% (TYP.)
Stand-by Current:	ISTB=1.0µA (MAX.)
Load Capacitors:	Low ESR capacitors compatible
Current Limiter Function:	Operates when ripple voltage =250mV (180kHz version)
	Also available without current limiter (100kHz and 500kHz types are available only without current limiter)
Packages :	SOT-25 / USP-6B

■ TYPICAL PERFORMANCE CHARACTERISTICS

XC9105D093MR
VOUT=3.3V, CL=20µF
When PWM/PFM Automatic Switching
Tr: XP161A1355PR

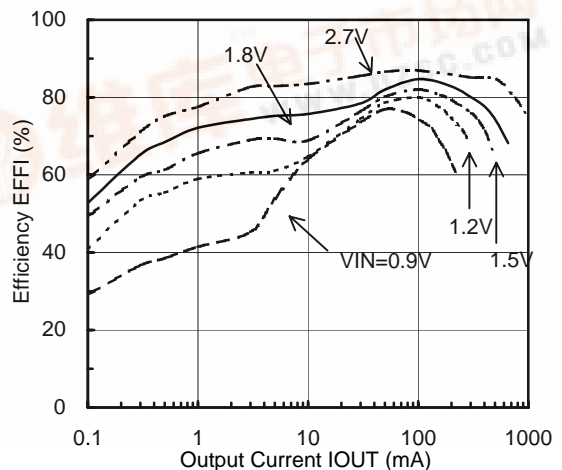

XC9103/04/05 Series

Ceramic Cap. Compatible **Step-Up DC/DC Converters**

■ PIN CONFIGURATION

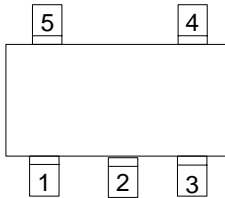

SOT-25
(TOP VIEW)
[SOT-23-5]

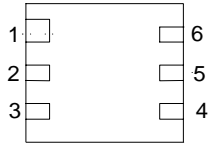

USP-6B
(TOP VIEW)

■ PIN ASSIGNMENT

PIN NUMBER		PIN NAME	FUNCTION
SOT-25	USP-6B		
1	6	FB	Output Resistor Connection
2	2	VDD	Supply Voltage
3	4	CE	Chip Enable (Operates in "H" level)
		CE (/PWM)	Serves as both PWM/PFM switching pin and CE pin for XC9105
4	3	GND	Ground
5	1	EXT	External Transistor Connection
-	5	NC	No Connection

■ ORDERING INFORMATION

XC9103①②③④⑤⑥

XC9103 Series: PWM Control

①	B	With Current Limiter
	D	Without Current Limiter (D type : 100kHz, 500kHz Only)
②	09	FB Voltage
③		
④	3	Oscillation Frequency: 300kHz
	1	100kHz
	2	180kHz
	5	500kHz (D type only)
⑤	M	Package: SOT-25 (1 reel = 3000 pcs.)
	D	USP-6B (1 reel = 3000 pcs.)
⑥	R	Embossed Tape: Standard Feed
	L	Reverse Feed

XC9104①②③④⑤⑥

XC9104 Series: PWM/PFM automatic switching control
(Same as XC9103 Series)

XC9105①②③④⑤⑥

XC9105 Series: PWM/PFM manual switching control
(Same as XC9103 Series)

■ PACKAGING INFORMATION

○ SOT-25 (SOT-23-5)

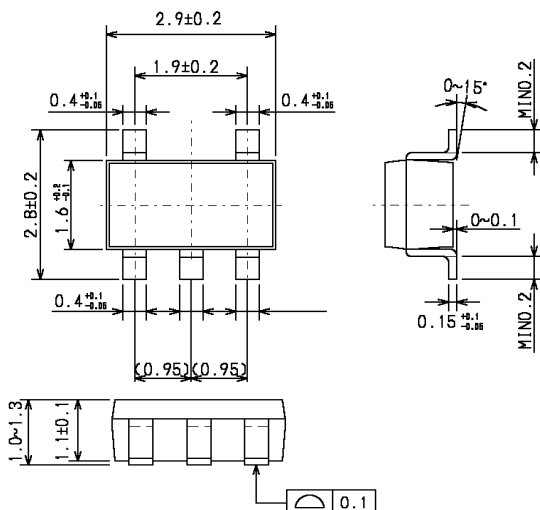

○ USP-6B

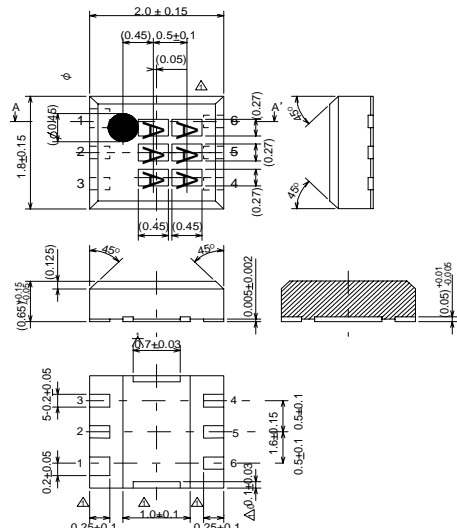

■ ABSOLUTE MAXIMUM RATINGS

Ta = 25°C

PARAMETER	SYMBOL	RATINGS	UNITS
VDD pin Voltage	VDD	-0.3 ~ 12	V
FB pin Voltage	FB	-0.3 ~ 12	V
CE pin Voltage	VCE	-0.3 ~ 12	V
EXT pin Voltage	VEXT	-0.3 ~ VDD + 0.3	V
EXT pin Current	IEXT/	±100	mA
Power Dissipation	Pd	SOT-25	150
		USP-6B	100
Operating Ambient Temperature	Topr	-40 ~ +85	°C
Storage Temperature	Tstg	-40 ~ +125	°C

■ BLOCK DIAGRAM

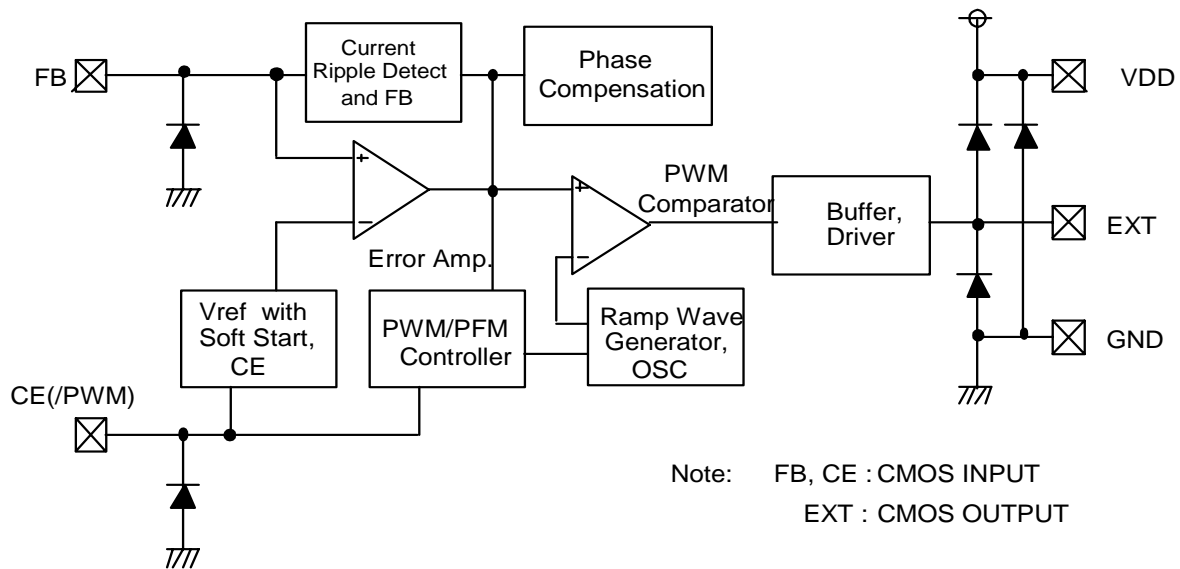

■ ELECTRICAL CHARACTERISTICS

XC9103B092MR, XC9104B092MR, XC9105B092MR
 XC9103D092MR, XC9104D092MR, XC9105D092MR

(FOSC=180 (kHz))

Ta=25°C

PARAMETER	SYMBOL	CONDITIONS	MIN.	TYP.	MAX.	UNITS	CIRCUIT
Output Voltage	VOUT		3.234	3.300	3.366	V	①
Output Voltage Range	VOUTSET	VIN=VOUTSET× 0.6, VDD=3.3V IOUT=10mA, Using 2SD1628	1.5	-	30.0	V	②
FB Control Voltage	VFB		0.882	0.900	0.918	V	④
*1 Power Supply Voltage Range	VDD		1.8	-	10	V	-
Operation Start Voltage	VST1	Recommended Circuit using 2SD1628, IOUT=1.0mA	-	-	0.9	V	③
*1 Oscillation Start Voltage	VST2	No external connections CE connected to VDD, Voltage applied, FB=0V	-	-	0.8	V	④
Operation Holding Voltage	VHLD	Recommended Circuit using 2SD1628, IOUT=1.0mA	-	-	0.7	V	③
Supply Current 1	IDD1	Same as VST2, VDD=3.300V	-	45	64	μA	④
Supply Current 2	IDD2	Same as IDD1, FB=1.2V	-	17	24	μA	④
Stand-by Current	ISTB	Same as IDD1, CE=0V	-	-	1.0	μA	⑤
Oscillation Frequency	FOSC	Same as IDD1	153	180	207	kHz	④
Maximum Duty Ratio	MAXDTY	Same as IDD1	75	81	87	%	④
PWM Duty Ratio	PFMDTY	No Load (XC9104B/D, 9105B/D)	20	28	36	%	①
*3 Overcurrent SENSE Voltage	VLMT	Step input to FB (Pulse width:2.0μS or more) EXT = Low level voltage (XC9103B, 9104B, 9105B)	170	250	330	mV	⑥
Efficiency	EFFI	Recommended Circuit using XP161A1355		85		%	①
Soft-start Time	TSS		5.0	10.0	20.0	mS	①
CE "High" Voltage	VCEH	Same as IDD1	0.65	-	-	V	⑤
CE "Low" Voltage	VCEL	Same as IDD1	-	-	0.20	V	⑤
*2 PWM "High" Voltage	VPWMH	IOUT=1.0mA (XC9105B/D)	VDD - 0.2	-		V	①
*2 PWM "Low" Voltage	VPWML	IOUT=1.0mA (XC9105B/D)	-		VDD - 1.0	V	①
EXT "High" ON Resistance	REXTH	Same as IDD1, VEXT=VOUT-0.4V	-	24	36	Ω	④
EXT "Low" ON Resistance	REXTL	Same as IDD1, VEXT=0.4V	-	16	24	Ω	④
CE "High" Current	ICEH	Same as IDD2, CE=VDD	-	-	0.1	μA	⑤
CE "Low" Current	ICEL	Same as IDD2, CE=0V	-	-	-0.1	μA	⑤
FB "High" Current	IFBH	Same as IDD2, FB=VDD	-	-	0.1	μA	⑤
FB "Low" Current	IFBL	Same as IDD2, FB=0V	-	-	-0.1	μA	⑤

Test Conditions: Unless otherwise stated, CL: ceramic capacitor, recommended MOS FET should be connected.

VOUT=3.30 (V), VIN=2.00 (V), IOUT=170 (mA)

■ NOTES

- *1 Although the IC starts step-up operations from a VDD of 0.8V, the output voltage and oscillation frequency are stabilized at VDD ≥ 1.8V. Therefore, a VDD of more than 1.8V is recommended when VDD is supplied from VIN or other power sources.
- *2 With the XC9105 series, the CE pin also serves as a PWM/PFM switching pin. In operation, PWM control is selected when the voltage at the CE pin is more than VDD -0.2V. On the other hand, PWM/PFM automatic switching control at a duty = 25% is selected when the voltage at the CE pin is less than VDD -1.0V and more than VCEH.
- *3 The overcurrent limit circuit of this IC is designed to monitor the ripple voltage so please select your external components carefully to prevent VLMT being reached under low temperature conditions as well as normal operating conditions. Following current limiter circuit operations, which in turn causes the IC's operations to stop, the operations of the IC can be returned to normal with a toggle of the CE pin or by turning the power supply back on.

■ ELECTRICAL CHARACTERISTICS (Continued)

XC9103B093MR, XC9104B093MR, XC9105B093MR

XC9103D093MR, XC9104D093MR, XC9105D093MR

(FOSC=300 (kHz))

Ta=25°C

PARAMETER	SYMBOL	CONDITIONS	MIN.	TYP.	MAX.	UNITS	CIRCUIT
Output Voltage	VOUT		3.234	3.300	3.366	V	①
Output Voltage Range	VOUTSET	VIN=VOUTSET× 0.6, VDD=3.3V IOUT=10mA, Using 2SD1628	1.5	-	30.0	V	②
FB Control Voltage	VFB		0.882	0.900	0.918	V	④
*1 Power Supply Voltage Range	VDD		1.8	-	10	V	-
Operation Start Voltage	VST1	Recommended Circuit using 2SD1628, IOUT=1.0mA	-	-	0.9	V	③
*1 Oscillation Start Voltage	VST2	No external connections CE connected to VDD, Voltage applied, FB=0V	-	-	0.8	V	④
Operation Holding Voltage	VHLD	Recommended Circuit using 2SD1628, IOUT=1.0mA	-	-	0.7	V	③
Supply Current 1	IDD1	Same as VST2, VDD=3.300V		62	88	μA	④
Supply Current 2	IDD2	Same as IDD1, FB=1.2V		16	22	μA	④
Stand-by Current	ISTB	Same as IDD1, CE=0V			1.0	μA	⑤
Oscillation Frequency	FOSC	Same as IDD1	255	300	345	kHz	④
Maximum Duty Ratio	MAXDTY	Same as IDD1	75	81	87	%	④
PWM Duty Ratio	PFMDTY	No Load (XC9104B/D, 9105B/D)	24	32	40	%	①
*3 Overcurrent SENSE Voltage	VLMT	Step input to FB (Pulse width:2.0μS or more) EXT = Low level voltage (XC9103B, 9104B, 9105B)	220	300	380	mV	⑥
Efficiency	EFF1	Recommended Circuit using XP161A1355	-	85	-	%	①
Soft-start Time	TSS		5.0	10.0	20.0	mS	①
CE "High" Voltage	VCEH	Same as IDD1	0.65	-	-	V	⑤
CE "Low" Voltage	VCEL	Same as IDD1	-	-	0.20	V	⑤
*2 PWM "High" Voltage	VPWMH	IOUT=1.0mA (XC9105B/D)	VDD - 0.2	-	-	V	①
*2 PWM "Low" Voltage	VPWML	IOUT=1.0mA (XC9105B/D)	-	-	VDD - 1.0	V	①
EXT "High" ON Resistance	REXTH	Same as IDD1, VEXT=VOUT-0.4V	-	24	36	Ω	④
EXT "Low" ON Resistance	REXTL	Same as IDD1, VEXT=0.4V	-	16	24	Ω	④
CE "High" Current	ICEH	Same as IDD2, CE=VDD	-	-	0.1	μA	⑤
CE "Low" Current	ICEL	Same as IDD2, CE=0V	-	-	-0.1	μA	⑤
FB "High" Current	IFBH	Same as IDD2, FB=VDD	-	-	0.1	μA	⑤
FB "Low" Current	IFBL	Same as IDD2, FB=0V	-	-	-0.1	μA	⑤

Test Conditions: Unless otherwise stated, CL: ceramic, recommended MOS FET should be connected.

VOUT=3.30 (V), VIN=2.00 (V), IOUT=170 (mA)

■ NOTES

- *1 Although the IC starts step-up operations from a VDD of 0.8V, the output voltage and oscillation frequency are stabilized at VDD ≥ 1.8V. Therefore, a VDD of more than 1.8V is recommended when VDD is supplied from VIN or other power sources.
- *2 With the XC9105 series, the CE pin also serves as a PWM/PFM switching pin. In operation, PWM control is selected when the voltage at the CE pin is more than VDD -0.2V. On the other hand, PWM/PFM automatic switching control at a duty = 25% is selected when the voltage at the CE pin is less than VDD -1.0V and more than VCEH.
- *3 The overcurrent limit circuit of this IC is designed to monitor the ripple voltage so please select your external components carefully to prevent VLMT being reached under low temperature conditions as well as normal operating conditions. Following current limiter circuit operations, which in turn causes the IC's operations to stop, the operations of the IC can be returned to normal with a toggle of the CE pin or by turning the power supply back on.

■ TYPICAL APPLICATION CIRCUIT

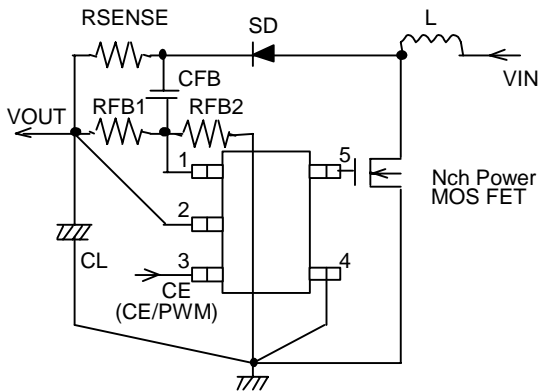

When obtaining VDD from a source other than VOUT, please insert a capacitor CIN between the VDD pin and the GND pin in order to provide stabler operations.
Please wire CL & CIN between the VOUT/VDD pin and the GND pin. Strengthen the wiring sufficiently.

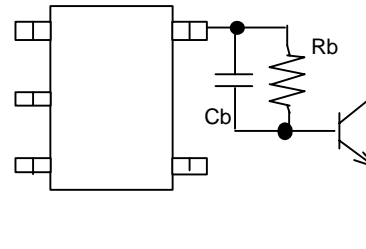

Insert Rb and CB when using a bipolar NPN Transistor.

■ HOW TO USE

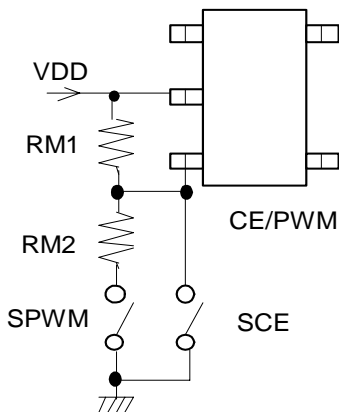

SCE	SPWM	CONDITIONS
ON	ON or OFF	Chip Disable
OFF	ON	Duty=25%, PWM/PFM automatic switching
OFF	OFF	PWM

By using external signals, the control of the XC9105 series can be switched between PWM control and PWM/PFM automatic switching control. By inputting a voltage of more than VDD -0.2V to the CE/PWM pin, PWM control can be selected. On the other hand, PWM/PFM automatic switching control can be selected by inputting a voltage of less than VDD -1.0V.

With the XC9105, by connecting resistors of the same value (RM1, RM2) as shown in the diagram to the left, it is possible to obtain chip disable with SCE ON and, SPWM ON or OFF, PWM/PFM auto switching at Duty=25% with SCE OFF & SPWM ON, & PFM control with both switches OFF.

Note:

When operating at VDD -1.8V and below (stepping-up from VIN=0.9V), it is necessary to pull-up to VDD in order to allow the CE/PWM pin reach the VCEH voltage level. Please make sure that the IC is in PWM control (SPWM=OFF) when operations start. If SPWM is ON, there are times when chip enable might not operate.

* Please select your external components carefully (refer to the page 8).

■ NOTE ON HOW TO USE B TYPE

When applying voltage to VDD through CE pin with the series' B type product, the limiter circuit may operate when a power supply is on, and the operation may not start. In this case, as the right circuit indicates, please connect a resistor and a capacitor with the CE pin. By the time constant, the CE pin will be chip enable after VDD rise so that IC will be in the stable condition.

Please set time constant equal to 10ms by the following equation.

Time constant : τ (s) = R (Ω) x C (F)

[Example of Equation] R = 100k Ω , C = 0.1 μ F

$$\begin{aligned} \tau \text{ (s)} &= R \text{ (}\Omega\text{)} \times C \text{ (F)} \\ &= 100\text{k}\Omega \times 0.1\mu\text{F} = 10\text{ms} \end{aligned}$$

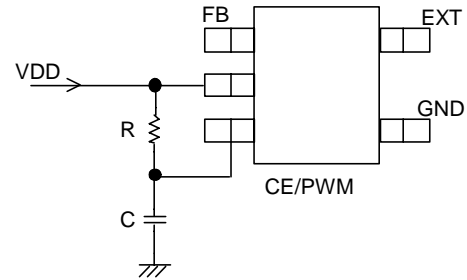

■ OPERATIONAL DESCRIPTION

The XC9103/04/05 series are step-up DC/DC converter controller ICs with built-in high speed, low ON resistance drivers.

<Error Amp.>

Error Amplifier is designed to monitor the output voltage, comparing the feedback voltage (FB) with the reference voltage Vref. In response to feedback of a voltage lower than the reference voltage Vref, the output voltage of the error amp. decreases.

<OSC Generator>

This circuit generates the internal reference clock.

<Ramp Wave Generator>

The Ramp Wave Generator generates a saw-tooth waveform based on outputs from the OSC Generator.

<PWM Comparator>

The PWM comparator compares outputs from the Error Amp. and saw-tooth waveform. When the voltage from the Error Amp's output is low, the external switch will be set to ON.

<PWM/PFM Controller>

This circuit generates PFM pulses.

The PWM/PFM automatic switching mode switches between PWM and PFM automatically depending on the load. The PWM/PFM automatic switching mode is selected when the voltage of the CE pin is less than VDD - 1.0V, and the control switches between PWM and PFM automatically depending on the load. PWM/PFM control turns into PFM control when threshold voltage becomes lower than voltage of error amps. PWM control mode is selected when the voltage of the CE pin is more than VDD - 0.2V. Noise is easily reduced with PWM control since the switching frequency is fixed. The series is suitable for noise sensitive portable audio equipment as PWM control can suppress noise during operation and PWM/PFM switching control can reduce consumption current during light load in stand-by.

<Vref 1 with Soft Start>

The reference voltage, Vref (FB pin voltage)=0.9V, is adjusted and fixed by laser trimming (for output voltage settings, please refer to the notes on page 8). To protect against inrush current, when the power is switched on, and also to protect against voltage overshoot, soft-start time is set internally to 10ms. It should be noted, however, that this circuit does not protect the load capacitor (CL) from inrush current. With the Vref voltage limited and depending upon the input to the error amps, the operation maintains a balance between the two inputs of the error amps and controls the EXT pin's ON time so that it doesn't increase more than is necessary.

<Enable Function>

This function controls the operation and shutdown of the IC. When the voltage of the CE pin is 0.2V or less, the mode will be disable, the channel's operations will stop and the EXT1 pin will be kept at a low level (the external N-type MOSFET will be OFF). When the IC is in a state of disable, current consumption will be no more than 1.0 μ A.

When the CE pin's voltage is 0.65V or more, the mode will be enable and operations will recommence.

■ FUNCTIONAL SETTINGS

< Output Voltage Setting >

Output voltage can be set by adding external split resistors. Output voltage is determined by the following equation, based on the values of RFB1 and RFB2. The sum of RFB1 and RFB2 should normally be 2 MΩ or less.

$$V_{OUT} = 0.9 \times (R_{FB1} + R_{FB2}) / R_{FB2}$$

The value of CFB1, speed-up capacitor for phase compensation, should result in $f_{zfb} = 1/(2\pi \times C_{FB} \times R_{FB1})$ equal to 5 to 30kHz. Adjustments are required depending on the application, value of inductance (L), and value of load capacity (CL).

fzfb = 30kHz (L=10μH)	[Example of Equation]
fzfb = 20kHz (L=22μH)	RFB1 : 120kΩ RFB2 : 45kΩ
fzfb = 10kHz (L=47μH)	CFB : 47pF (fzfb = 30kHz, L = 10μH)
	68pF (fzfb = 20kHz, L = 22μH)
	130pF (fzfb = 10kHz, L = 47μH)

< The use of ceramic capacitor CL >

The circuit of the XC9103/04/05 series is organized by a specialized circuit which reenacts negative feedback of both voltage and current. Also by insertion of approximately 100mΩ of a low and inexpensive sense resistor as current sense, a high degree of stability is possible even using a ceramic capacitor, a condition which used to be difficult to achieve. Compared to a tantalum condenser, because the series can be operated in a very small capacity, it is suited to use of the ceramic capacitor which is cheap and small.

< External Components >

Tr:	*When a MOSFET is used : XP161A1355PR (TOREX Nch. Power MOSFET) Note* : As the breakdown voltage of XP161A1355 is 8V, take care with the power supply voltage. With output voltages over 6V, use the XP161A1265 with a breakdown voltage of 12V. VST1: XP161A1355 PR =1.2V (max.) XP161A1265PR = 1.5V (max.)	*When a NPN Tr. Is used : 2SD1628 (Sanyo) Rb : 500Ω (adjust with Tr's HSE or load) Cb : 2200pF (ceramic type) $C_b \leq 1 / (2\pi \times R_b \times F_{OSC} \times 0.7)$
-----	--	--

SD: MA2Q737 (Schottky type, MATSUSHITA)

L, CL: When using ceramic type

L: 22μH (SUMIDA CDRH5D28, FOSC = 100, 180kHz)

10μH (SUMIDA CDRH5D18, FOSC = 300, 500kHz)

CL: 10V 10μF (ceramic type, TAIYO YUDEN LMK325BJ106ML)

Use the formula below when step-up ratio and output current is large.

$$CL = (CL \text{ standard value}) \times (I_{OUT}(\text{mA}) / 300\text{mA} \times V_{OUT} / V_{IN})$$

RSENSE: 100mΩ (FOSC = 180, 300, 500kHz)

50mΩ (FOSC = 100kHz)

CL: Tantalum Type

L: 22μH (SUMIDA CDRH5D28, FOSC = 300kHz)

47μH (SUMIDA CDRH5D28, FOSC = 100, 180kHz)

Except when $I_{OUT}(\text{mA}) / 100\text{mA} \times V_{OUT} / V_{IN} > 2 \rightarrow 22\mu\text{H}$

10μH (SUMIDA CDRH5D18, FOSC = 500kHz)

CL: 16V 47μF (tantalum type NICHICHEMI 16MCE476MD2)

Use the formula below when step-up ratio and output current is large.

$$CL = (CL \text{ standard value}) \times (I_{OUT}(\text{mA}) / 300\text{mA} \times V_{OUT} / V_{IN})$$

RSENSE: Not required, but short out the wire.

CL: AL Electrolytic Type

L: 22μH (SUMIDA CDRH5D28, FOSC = 300kHz)

47μH (SUMIDA CDRH5D28, FOSC = 100, 180kHz)

Except when $I_{OUT}(\text{mA}) / 100\text{mA} \times V_{OUT} / V_{IN} > 2 \rightarrow 22\mu\text{H}$

CL: 16V 100μF (AL electrolytic type) + 10V 2.2μF (ceramic type)

Strengthen appropriately when step-up ratio and output current is large.

RSENSE: Not required, but short out the wire.

CFB: Set up so that fzfb = 100kHz

TEST CIRCUITS

CIRCUIT ①

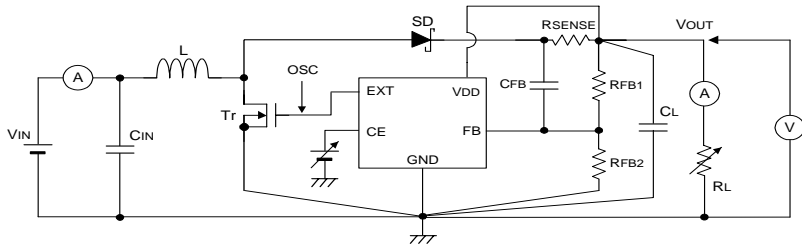

CIRCUIT ④

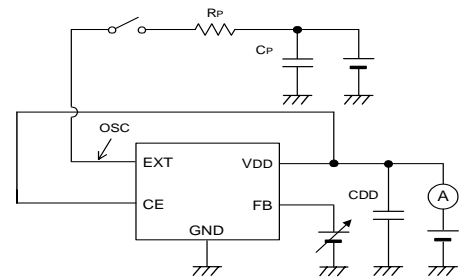

CIRCUIT ②

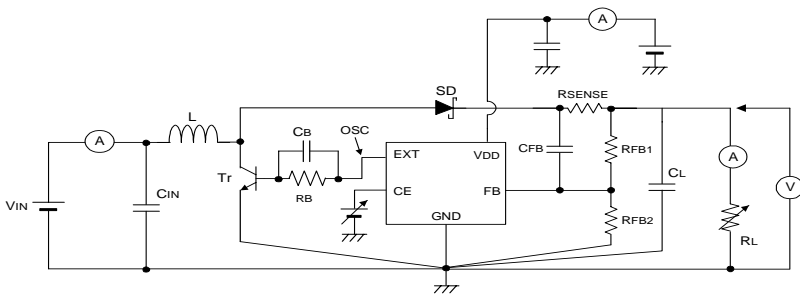

CIRCUIT ⑤

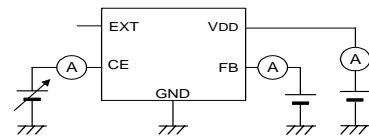

CIRCUIT ③

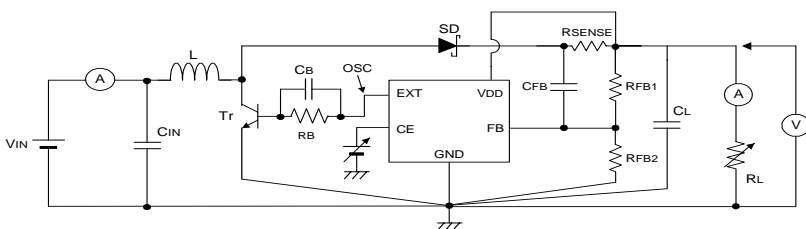

CIRCUIT ⑥

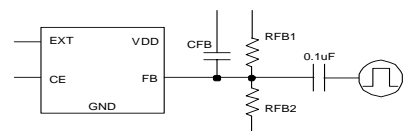

■ TYPICAL PERFORMANCE CHARACTERISTICS

(1) Output Voltage vs. Output Current

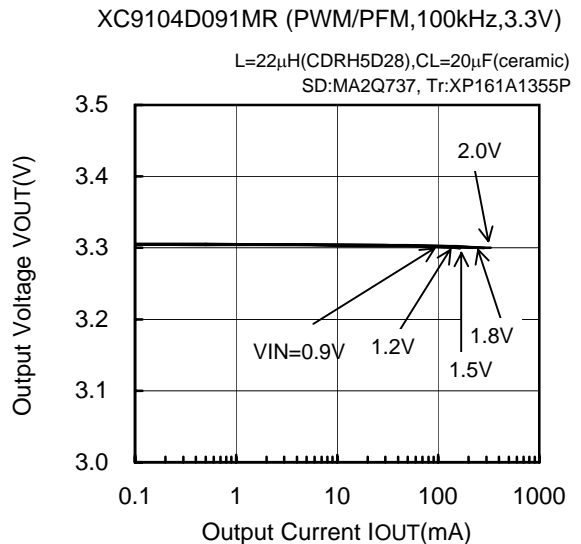
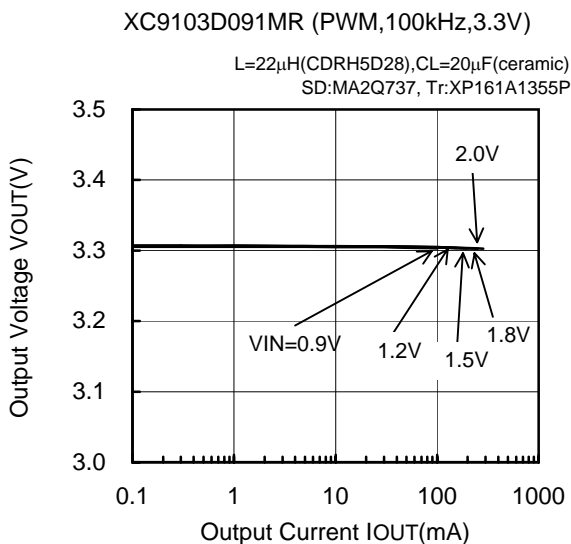
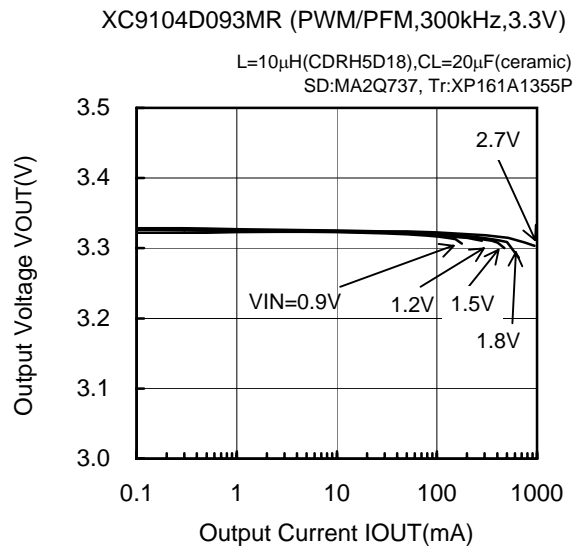
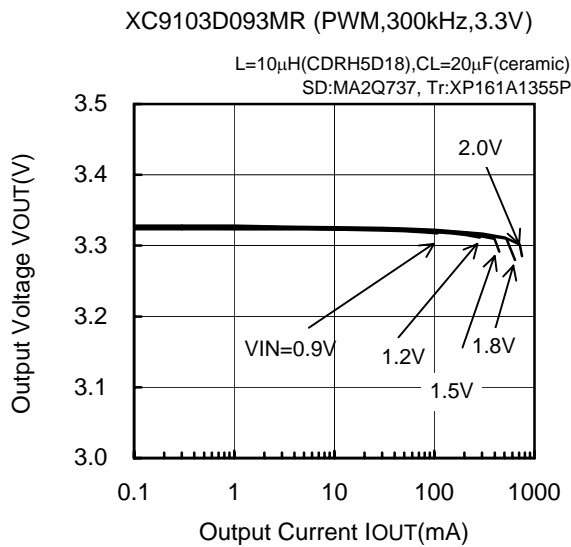
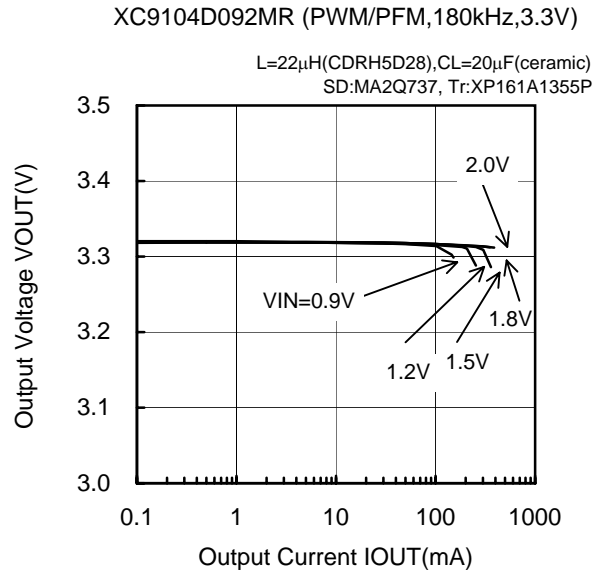
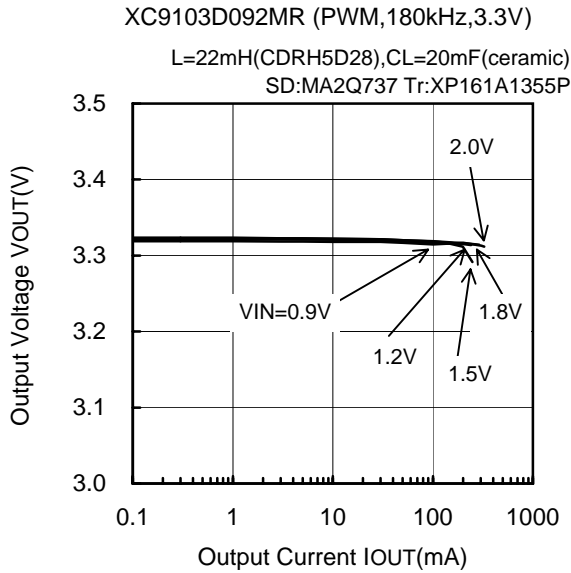

(1) Output Voltage vs. Output Current (Contd.)

XC9103D095MR (PWM,500kHz,3.3V)

L=10 μ H(CDRH5D18), CL=20 μ F(ceramic)
SD:MA2Q737, Tr:XP161A1355P

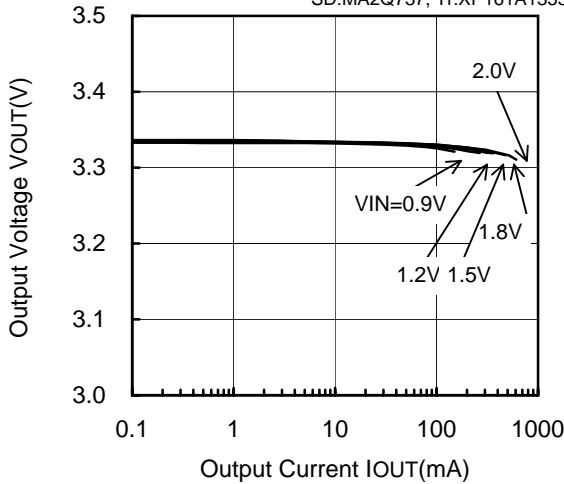

XC9104D095MR (PWM/PFM,500kHz,3.3V)

L=10 μ H(CDRH5D18), CL=20 μ F(ceramic)
SD:MA2Q737, Tr:XP161A1355P

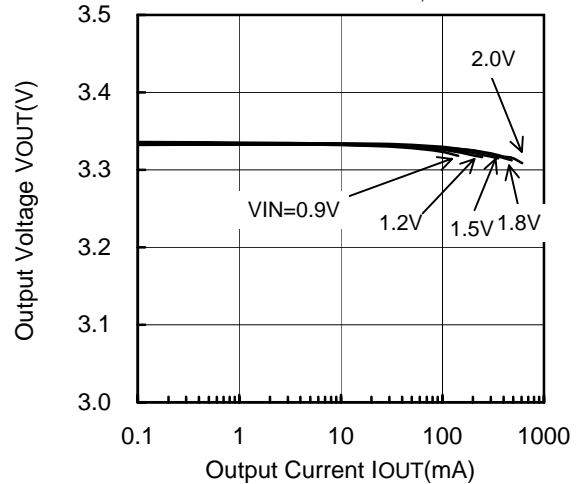

XC9103D092MR (PWM,180kHz,3.3V)

L=22 μ H(CDRH5D28), CL=47 μ F(tantalum)
SD:MA2Q737, Tr:XP161A1355P

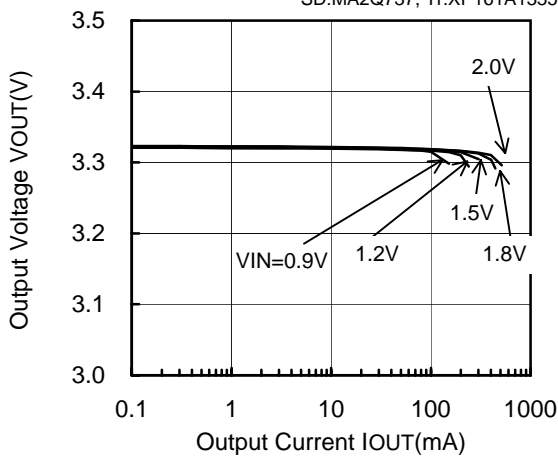

XC9104D092MR (PWM/PFM,180kHz,3.3V)

L=22 μ H(CDRH5D28), CL=47 μ F(tantalum)
SD:MA2Q737, Tr:XP161A1355P

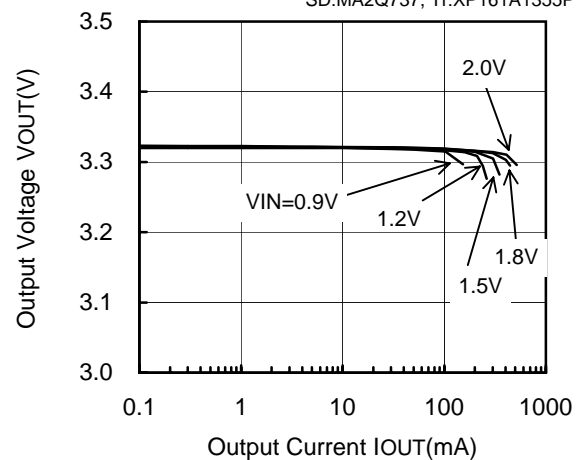

XC9103D093MR (PWM,300kHz,3.3V)

L=22 μ H(CDRH5D28), CL=94 μ F(tantalum)
SD:MA2Q737, Tr:XP161A1355P

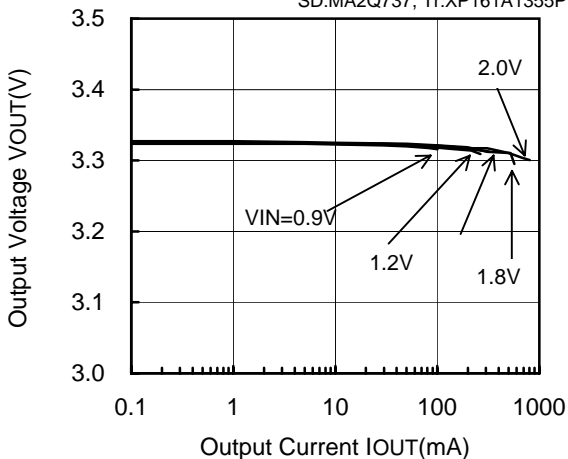

XC9104D093MR (PWM/PFM,300kHz,3.3V)

L=22 μ H(CDRH5D28), CL=94 μ F(tantalum)
SD:MA2Q737, Tr:XP161A1355P

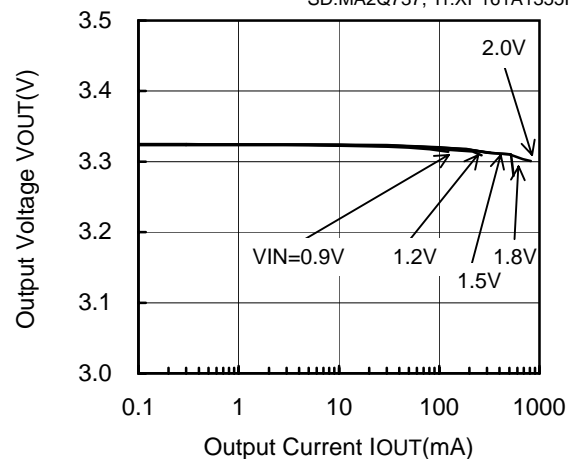

(2) Efficiency vs. Output Current

XC9103D092MR (PWM,180kHz,3.3V)

L=22 μ H(CDRH5D28), CL=20 μ F(ceramic)
SD:MA2Q737, Tr:XP161A1355P

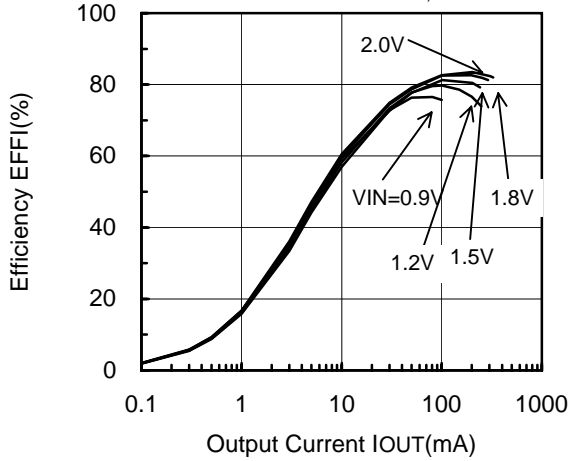

XC9104D092MR (PWM/PFM,180kHz,3.3V)

L=22 μ H(CDRH5D28), CL=20 μ F(ceramic)
SD:MA2Q737, Tr:XP161A1355P

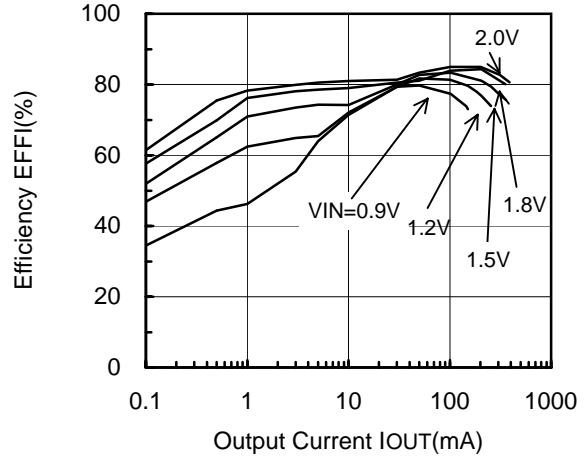

XC9103D093MR (PWM,300kHz,3.3V)

L=10 μ H(CDRH5D18), CL=20 μ F(ceramic)
SD:MA2Q737, Tr:XP161A1355P

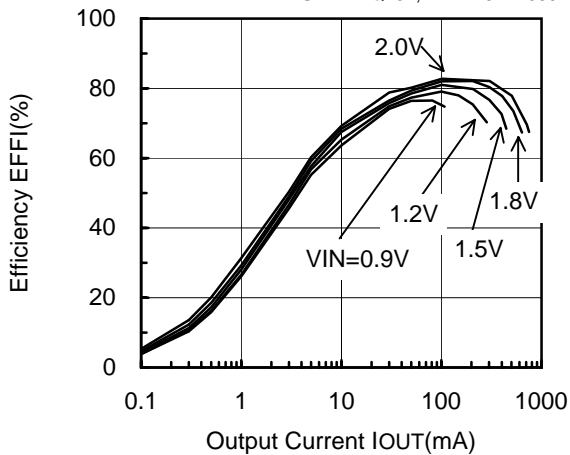

XC9104D093MR (PWM/PFM,300kHz,3.3V)

L=10 μ H(CDRH5D18), CL=20 μ F(ceramic)
SD:MA2Q737, Tr:XP161A1355P

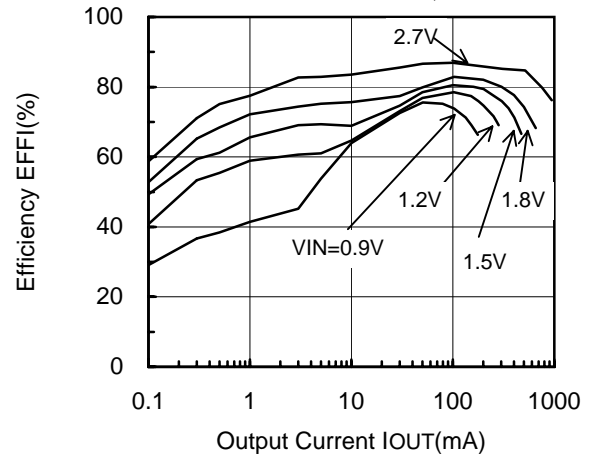

XC9103D091MR (PWM,100kHz,3.3V)

L=22 μ H(CDRH5D28), CL=20 μ F(ceramic)
SD:MA2Q737, Tr:XP161A1355P

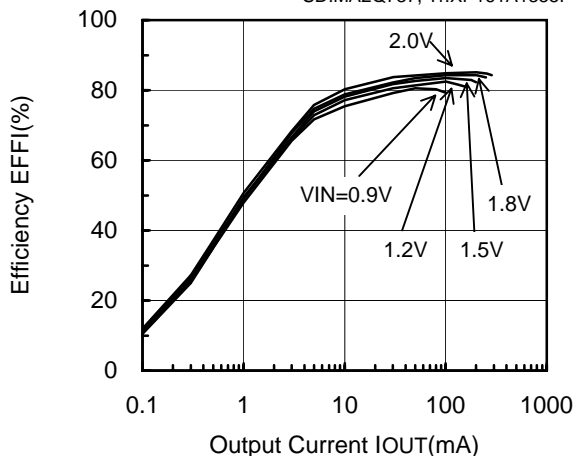

XC9104D091MR (PWM/PFM,100kHz,3.3V)

L=22 μ H(CDRH5D28), CL=20 μ F(ceramic)
SD:MA2Q737, Tr:XP161A1355P

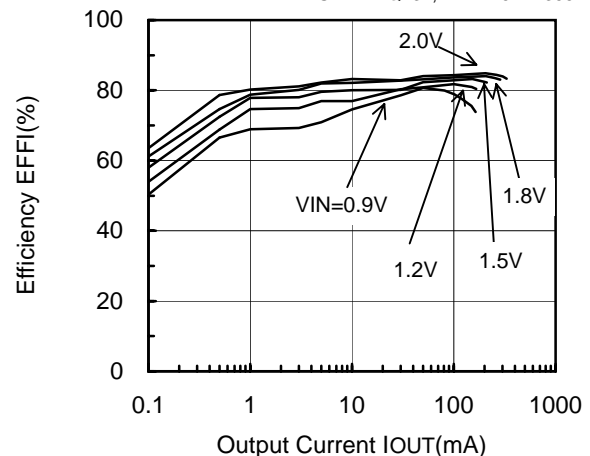

(2) Efficiency vs. Output Current (Contd.)

XC9103D095MR (PWM,500kHz,3.3V)

L=10 μ H(CDRH5D18), CL=20 μ F(ceramic)
SD:MA2Q737, Tr:XP161A1355P

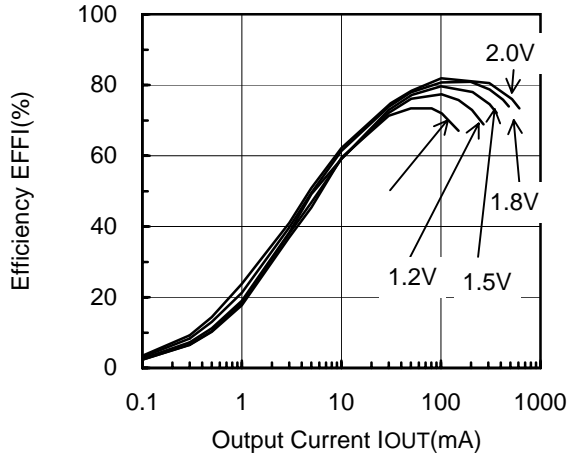

XC9104D095MR (PWM/PFM,500kHz,3.3V)

L=10 μ H(CDRH5D18), CL=20 μ F(ceramic)
SD:MA2Q737, Tr:XP161A1355P

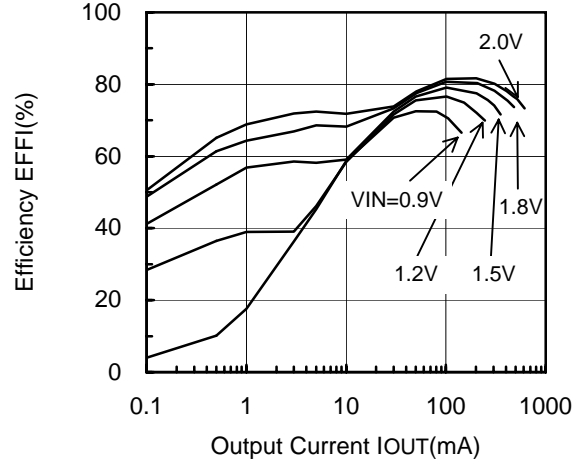

XC9103D092MR (PWM,180kHz,3.3V)

L=22 μ H(CDRH5D28), CL=47 μ F(tantalum)
SD:MA2Q737, Tr:XP161A1355P

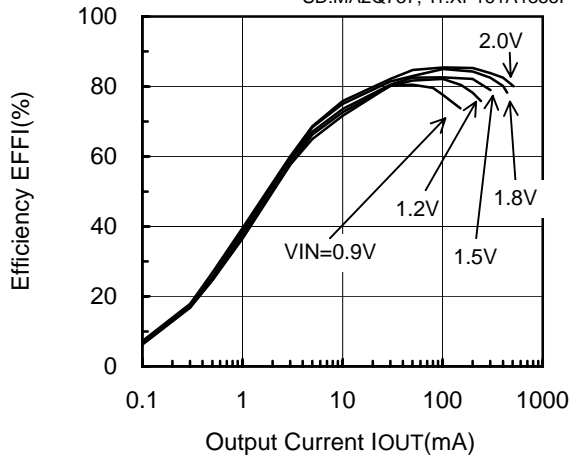

XC9104D092MR (PWM/PFM,180kHz,3.3V)

L=22 μ H(CDRH5D28), CL=47 μ F(tantalum)
SD:MA2Q737, Tr:XP161A1355P

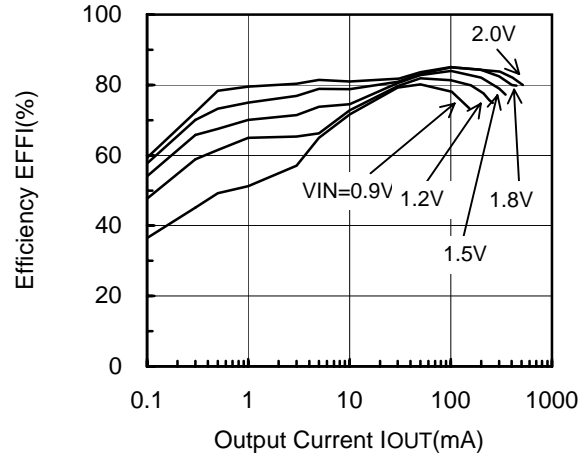

XC9103D093MR (PWM,300kHz,3.3V)

L=22 μ H(CDRH5D28), CL=94 μ F(tantalum)
SD:MA2Q737, Tr:XP161A1355P

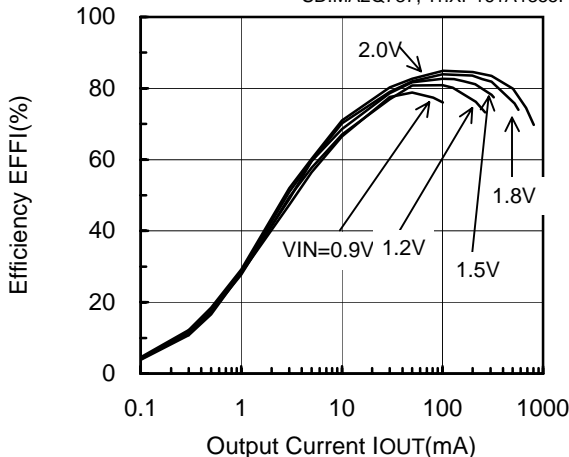

XC9104D093MR (PWM/PFM,300kHz,3.3V)

L=22 μ H(CDRH5D28), CL=94 μ F(tantalum)
SD:MA2Q737, Tr:XP161A1355P

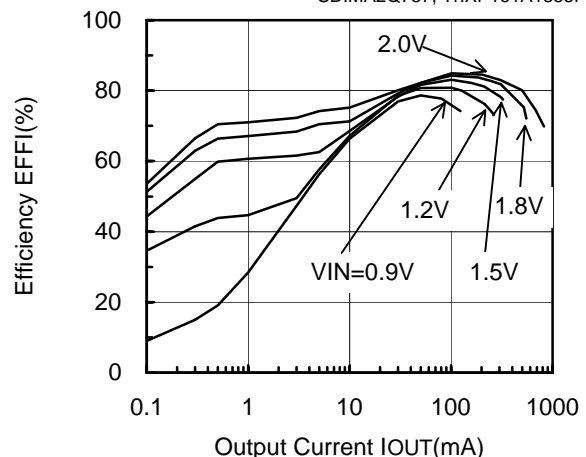

(3) Load Transient Response

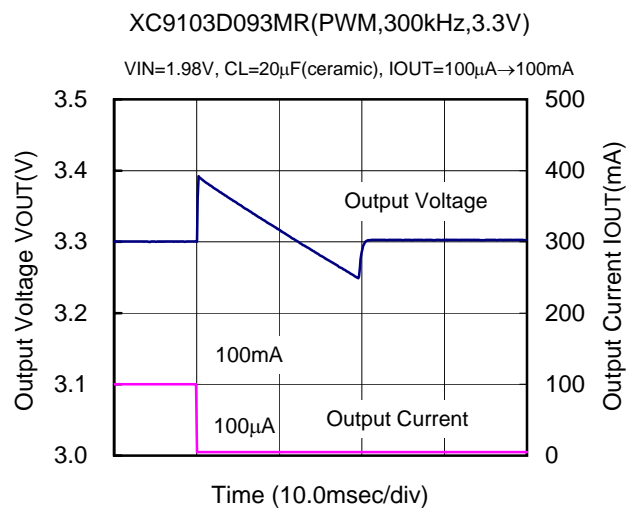
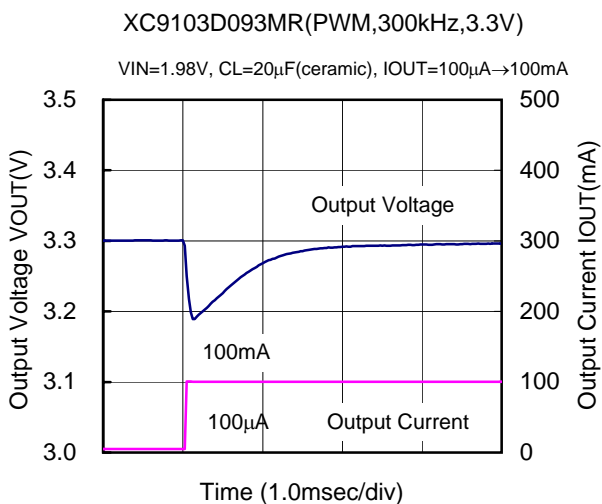
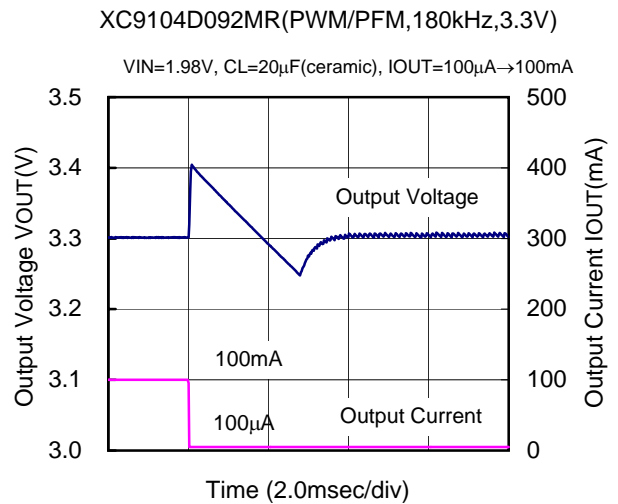
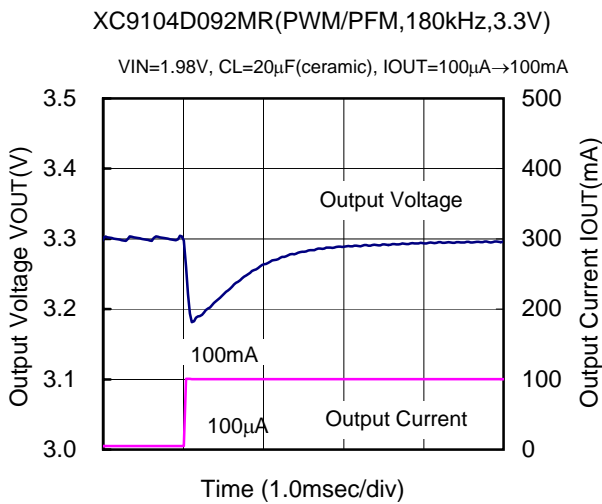
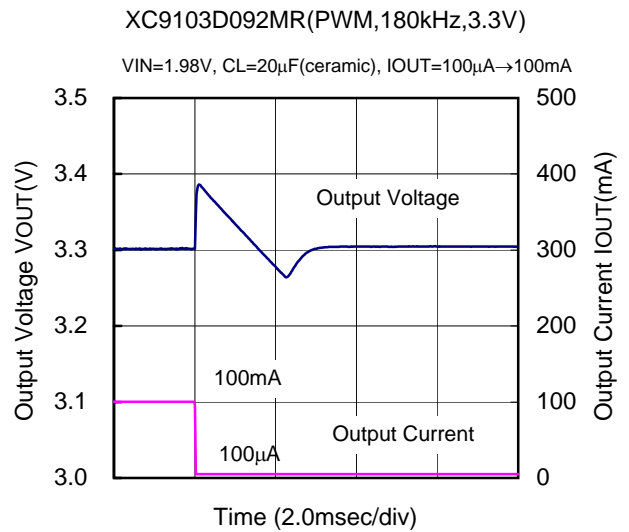
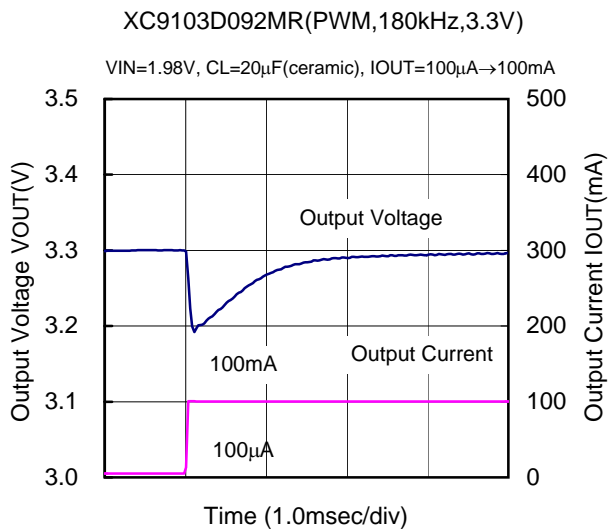

(3) Load Transient Response (Contd.)

XC9104D093MR(PWM/PFM,300kHz,3.3V)

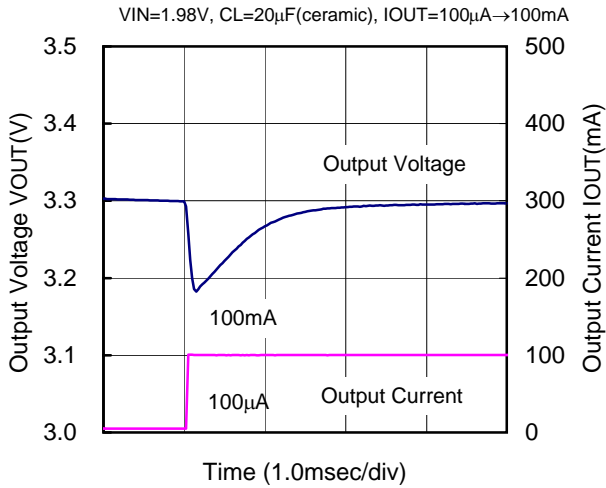

XC9104D093MR(PWM/PFM,300kHz,3.3V)

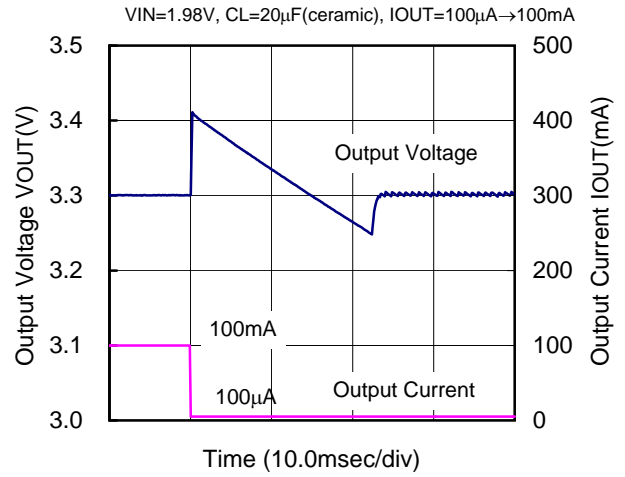

XC9103D092MR(PWM,180kHz,3.3V)

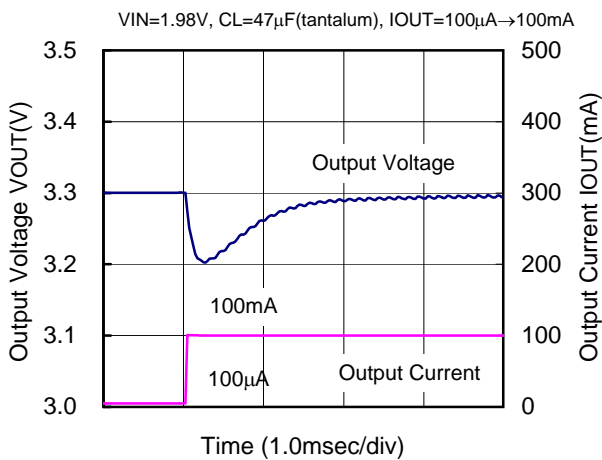

XC9103D092MR(PWM,180kHz,3.3V)

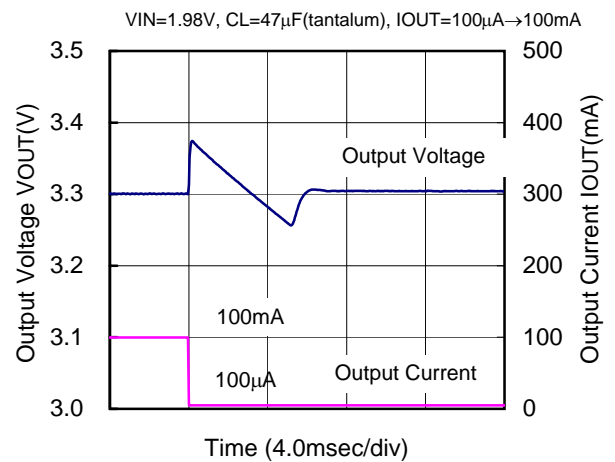

XC9104D092MR(PWM/PFM,180kHz,3.3V)

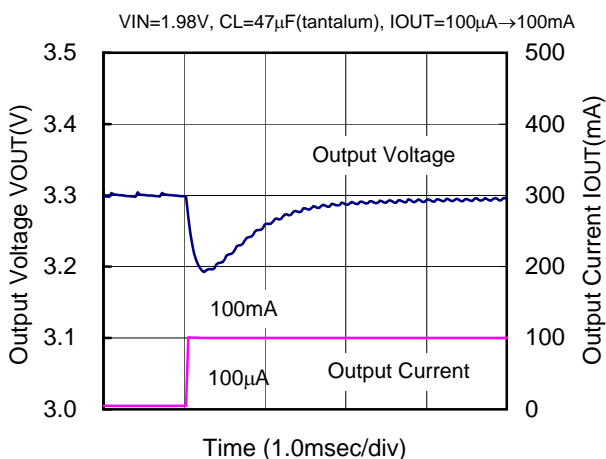

XC9104D092MR(PWM/PFM,180kHz,3.3V)

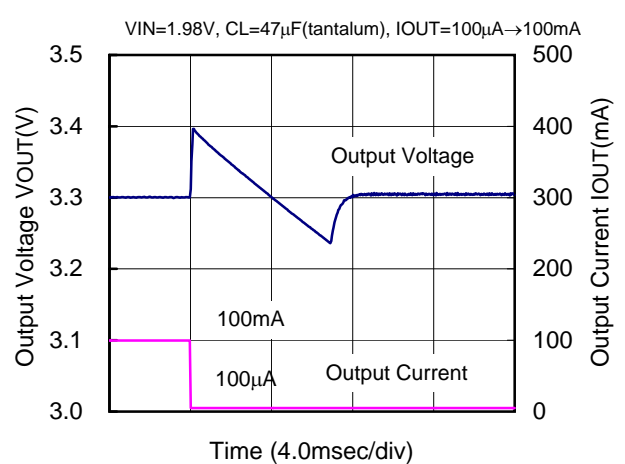

(4) Output Voltage vs. Power Supply Voltage

XC9105D092MR (180kHz, 3.3V)

L=22 μ H(CDRH5D28), CL=20 μ F(ceramic)
SD:MA2Q737, TXP161A1355P

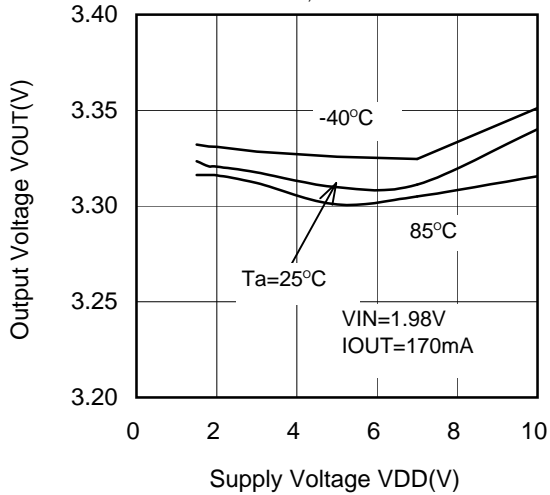

(5) Supply Current 1 vs. Power Supply Voltage

XC9105D092MR(180kHz)

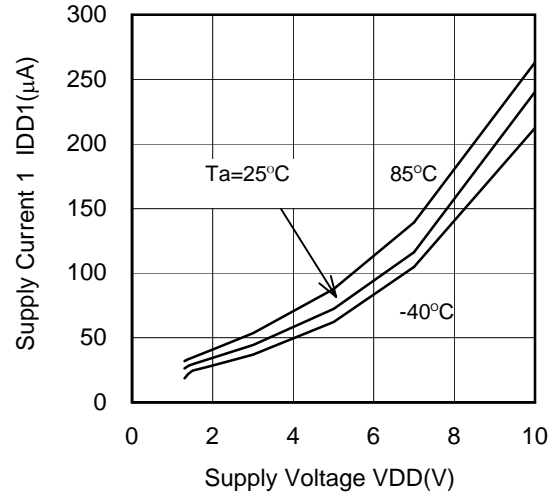

(6) Supply Current 2 vs. Power Supply Voltage

XC9105D092MR(180kHz)

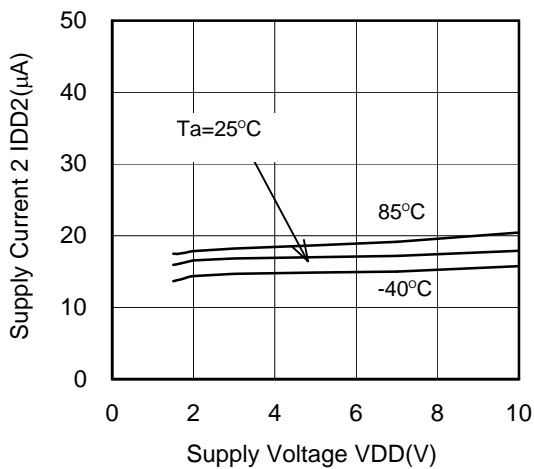

(7) Stand-by Current vs. Power Supply Voltage

XC9105D092MR(180kHz)

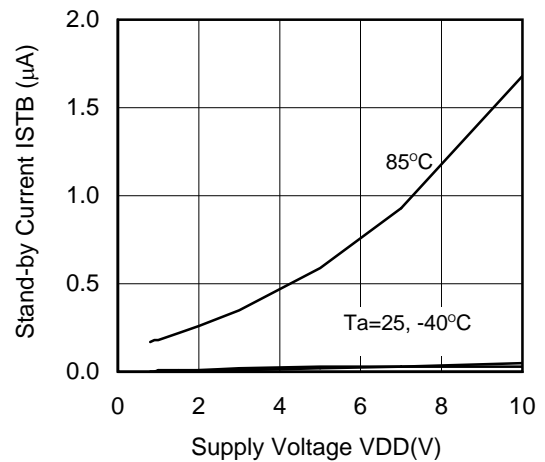

(8) Oscillation Frequency vs. Power Supply Voltage

XC9105D092MR(180kHz)

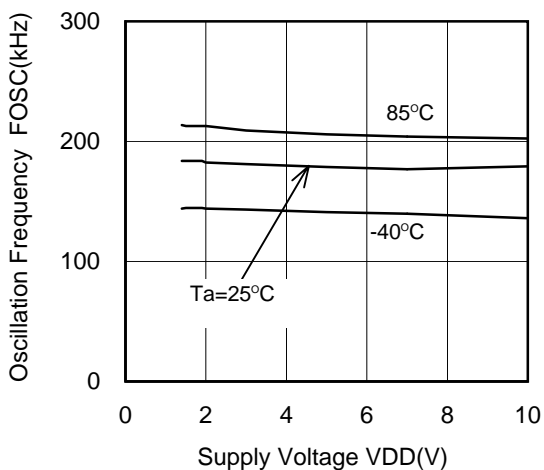

(9) Maximum Duty Ratio vs. Power Supply Voltage

XC9105D092MR(180kHz)

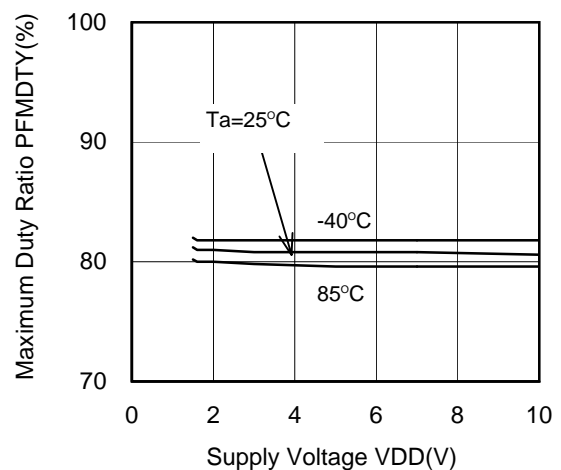

(10) PFM Duty Ratio vs. Power Supply Voltage

XC9105D092MR(180kHz)

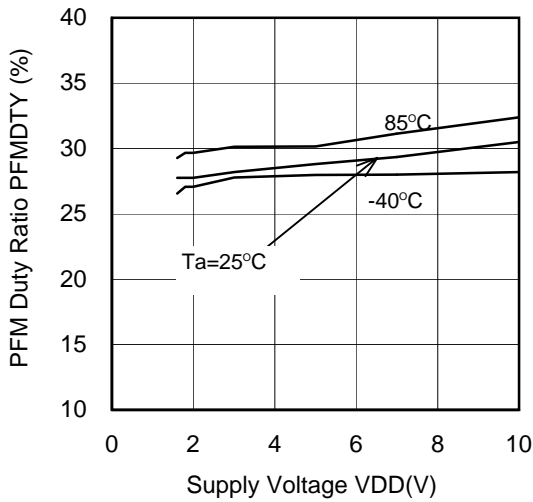

(11) Overcurrent SENSE Voltage vs. Power Supply Voltage

XC9105D092MR(180kHz)

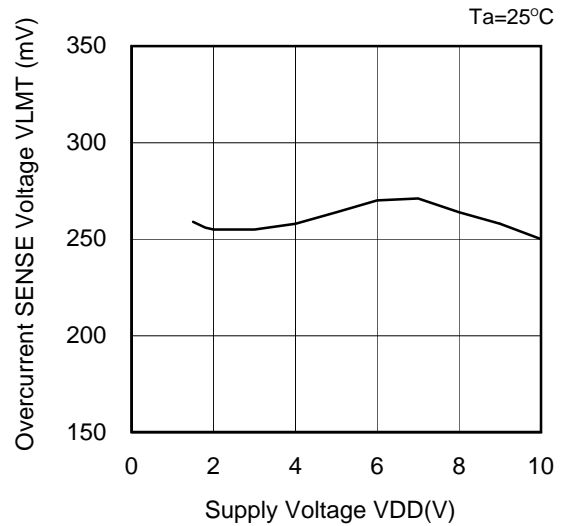

(12) Soft Start Time vs. Power Supply Voltage

XC9105D092MR(180kHz)

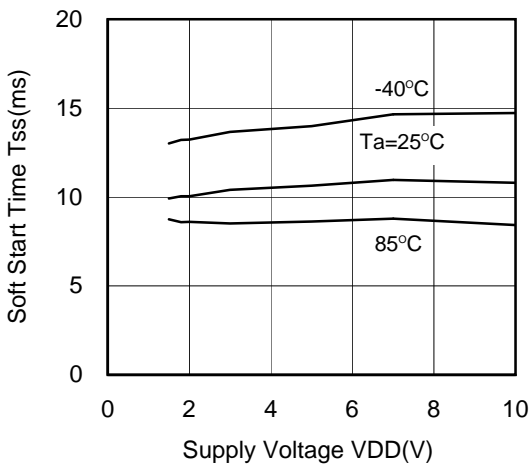

(13) CE "H" "L" Voltage vs. Power Supply Voltage

XC9105D092MR(180kHz)

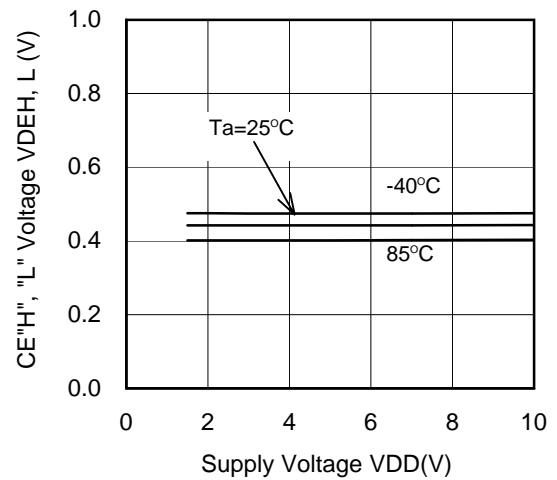

(14) PWM "H" "L" Voltage vs. Power Supply Voltage

XC9105D092MR(180kHz)

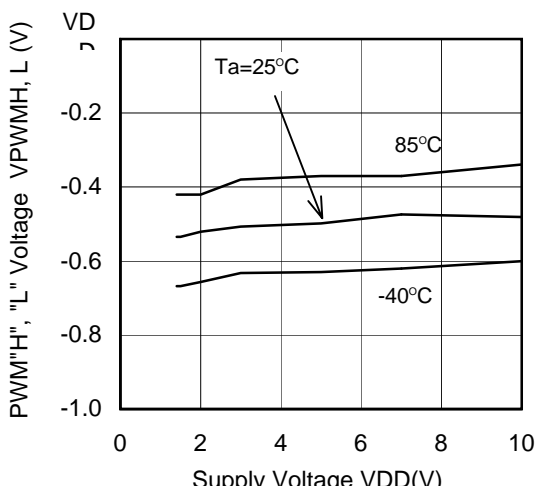

(15) EXT "H" ON Resistance vs. Power Supply Voltage

XC9105D092MR(180kHz)

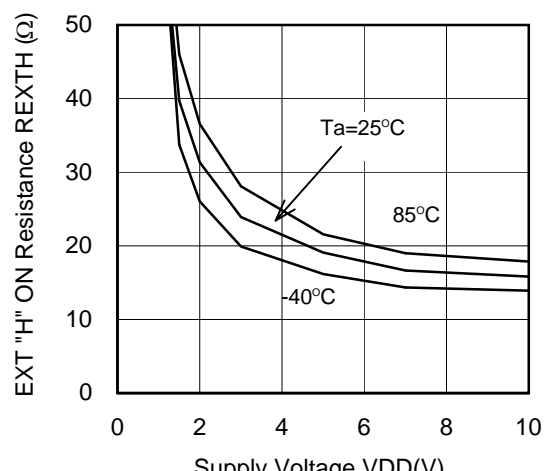

(16) EXT "L" ON Resistance vs. Power Supply Voltage

XC9105D092MR(180kHz)

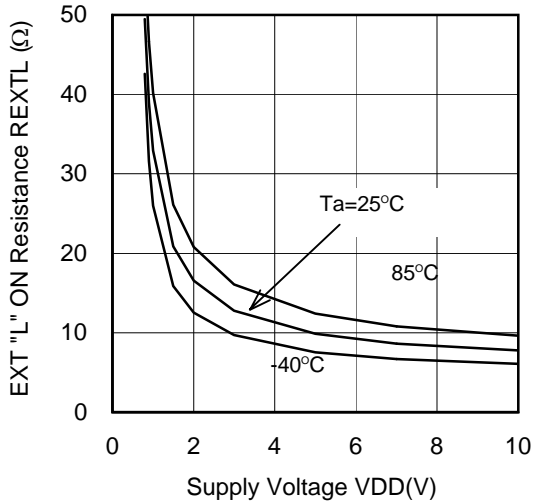

(17) Operation Start Voltage vs. Ambient Temperature

XC9105D092MR (180kHz,3.3V)

L=22μH(CDRH5D28),CL=20μF(ceramic)
SD:MA2Q737, Tr:2SD1628G

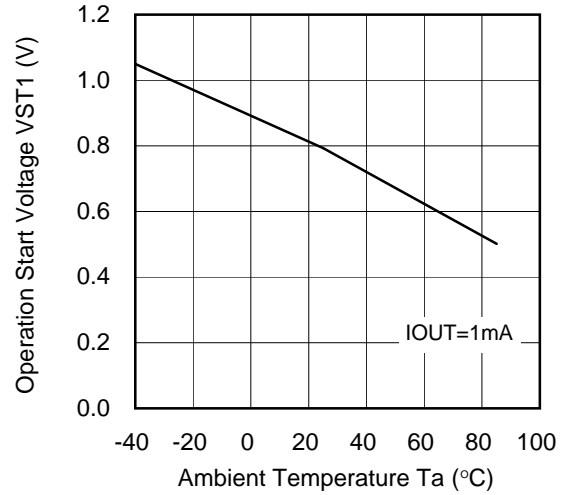

(18) Operation Hold Voltage vs. Ambient Temperature

XC9105D092MR (180kHz,3.3V)

L=22μH(CDRH5D28), CL=20μF(ceramic)
SD:MA2Q737, Tr:2SD1628G

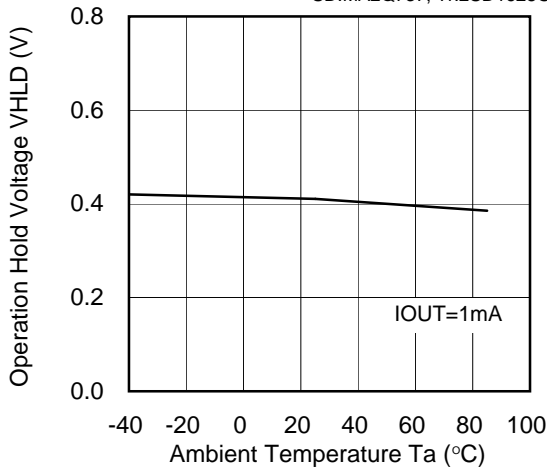

(19) Oscillation Start Voltage vs. Ambient Temperature

XC9105D092MR (180kHz,3.3V)

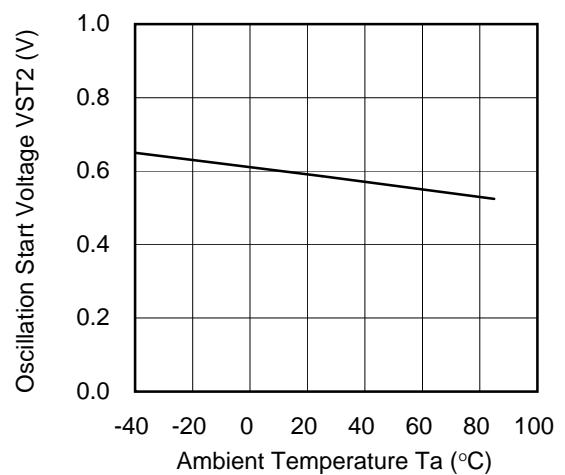

(20) Supply Current 1 vs. Power Supply Voltage

XC9105D093/095MR(300,500kHz)

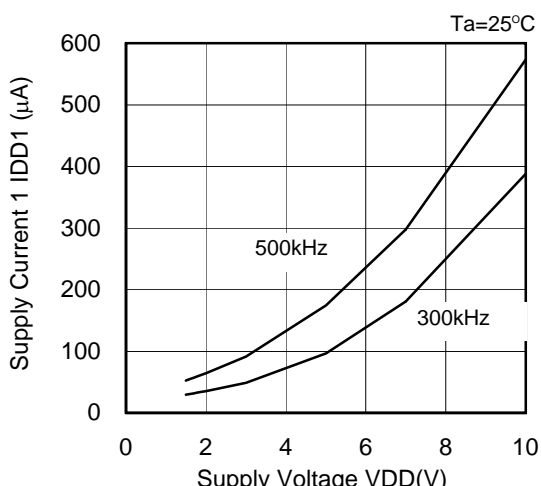

(21) Supply Current 2 vs. Power Supply Voltage

XC9105D093/095MR(300,500kHz)

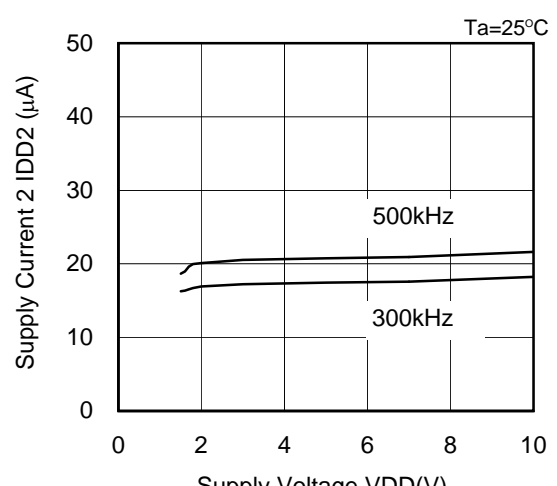

(22) Oscillation Frequency vs. Power Supply Voltage

XC9105D093/095MR (300,500kHz)

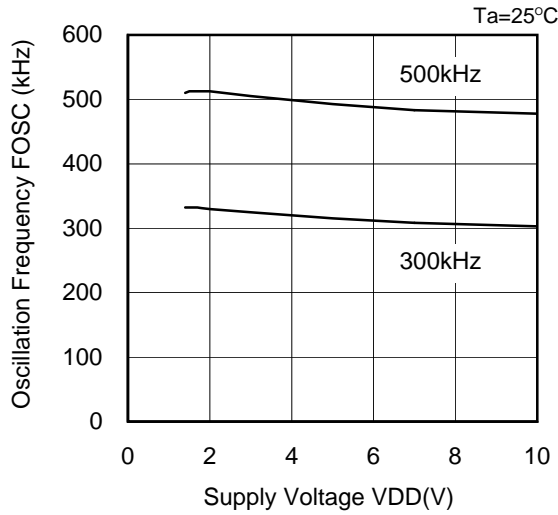

(23) Maximum Duty Ratio vs. Power Supply Voltage

XC9105D093/095MR(300,500kHz)

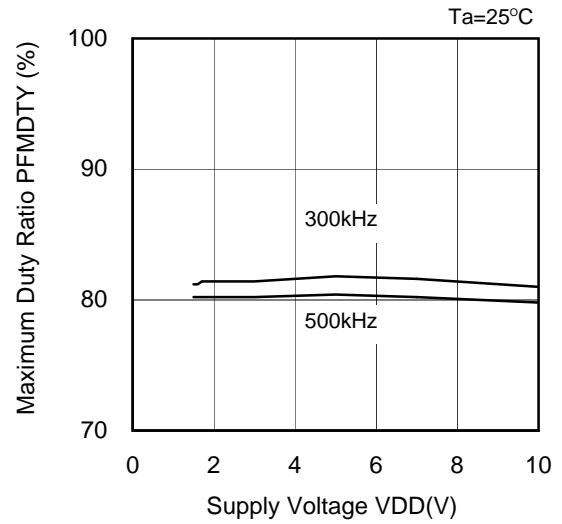

(24) PFM Duty Ratio vs. Power Supply Voltage

XC9105D093/095MR(300,500kHz)

Ta=25°C

