



CYPRESS

CY23FS04

FailSafe™ 2.5V/ 3.3V Zero Delay Buffer

Features

- Internal DCXO for continuous glitch-free operation
- Zero input-output propagation delay
- Low-jitter (< 35 ps RMS) outputs
- Low Output-to-Output skew (< 200 ps)
- 4.17 MHz–170 MHz reference input
- Supports industry standard input crystals
- 170 MHz outputs
- 5V-tolerant inputs
- Phase-locked loop (PLL) Bypass Mode
- Dual Reference Inputs
- 16-pin TSSOP
- 2.5V or 3.3V output power supplies
- 3.3V core power supply
- Industrial temperature available

Functional Description

The CY23FS04 is a FailSafe™ zero delay buffer with two reference clock inputs and four phase-aligned outputs. The device provides an optimum solution for applications where continuous operation is required in the event of a primary clock failure.

The continuous, glitch-free operation is achieved by using a DCXO, which serves as a redundant clock source in the event of a reference clock failure by maintaining the last frequency and phase information of the reference clock.

The unique feature of the CY23FS04 is that the DCXO is in fact the primary clocking source, which is synchronized (phase-aligned) to the external reference clock. When this external clock is restored, the DCXO automatically resynchronizes to the external clock.

The frequency of the crystal, which will be connected to the DCXO must be chosen to be an integer factor of the frequency of the reference clock. This factor is set by two select lines: S[2:1], please see *Table 1*. Output power supply, VDD can be connected to either 2.5V or 3.3V. VDDC is the power supply pin for internal circuits and must be connected to 3.3V.

Block Diagram

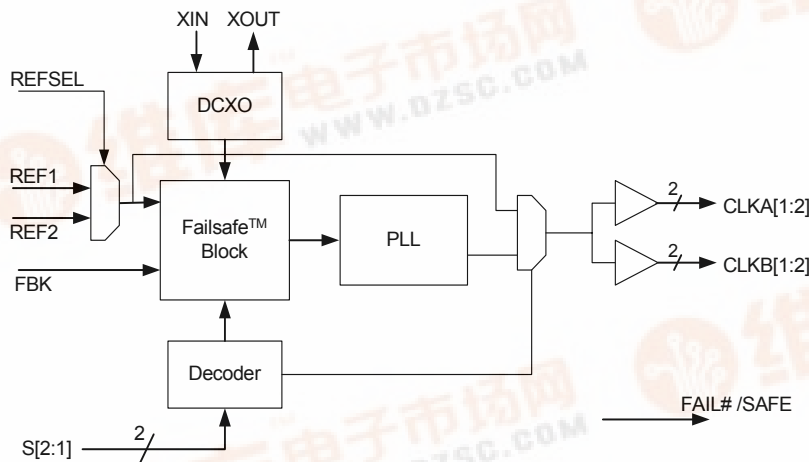

Pin Configuration

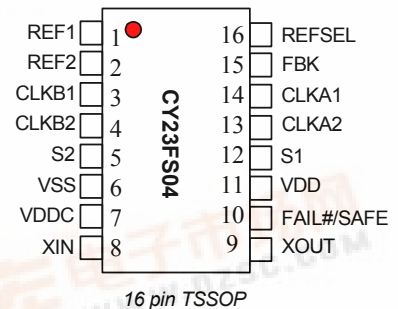

16 pin TSSOP



Pin Definition

Pin Number	Pin Name	Description
1,2	REF[1:2]	Reference clock inputs. 5V-tolerant ^[4] .
3,4	CLKB[1:2]	Bank B clock outputs. ^[1,2]
14,13	CLKA[1:2]	Bank A clock outputs. ^[1,2]
15	FBK	Feedback input to the PLL. ^[1,4]
12,5	S[1:2]	Frequency select pins and PLL and DCXO bypass mode. ^[3]
8	XIN	Reference crystal input.
9	XOUT	Reference crystal output.
10	FAIL#/SAFE	Valid reference indicator. A high level indicates a valid reference input.
11	VDD	2.5V or 3.3V power supply.
7	VDDC	3.3V power supply.
6	VSS	Ground.
16	REFSEL	Reference select. Selects the active reference clock from either REF1 or REF2. REFSEL = 1, REF1 is selected, REFSEL = 0, REF2 is selected.

Table 1. Configuration Table

S[2:1]	XTAL (MHz)		REF (MHz)		OUT (MHz)		REF:OUT ratio	REF:XTAL ratio	Out:XTAL ratio
	Min.	Max.	Min.	Max.	Min.	Max.			
00			PLL and DCXO Bypass Mode						
01	8.33	30.00	4.17	15.00	4.17	15.00	x1	1/2	1/2
10	8.00	25.00	16.00	50.00	16.00	50.00	x1	2	2
11	8.33	28.33	50.00	170.00	50.00	170.00	x1	6	6

FailSafe Function

The CY23FS04 is targeted at clock distribution applications that could or which currently require continued operation should the main reference clock fail. Existing approaches to this requirement have utilized multiple reference clocks with either internal or external methods for switching between references. The problem with this technique is that it leads to interruptions (or glitches) when transitioning from one reference to another, often requiring complex external circuitry or software to maintain system stability. The technique imple-

mented in this design completely eliminates any switching of references to the PLL, greatly simplifying system design.

The CY23FS04 PLL is driven by the crystal oscillator, which is phase-aligned to an external reference clock so that the output of the device is effectively phase-aligned to reference via the external feedback loop. This is accomplished by utilizing a digitally controlled capacitor array to pull the crystal frequency over an approximate range of ± 300 ppm from its nominal frequency.

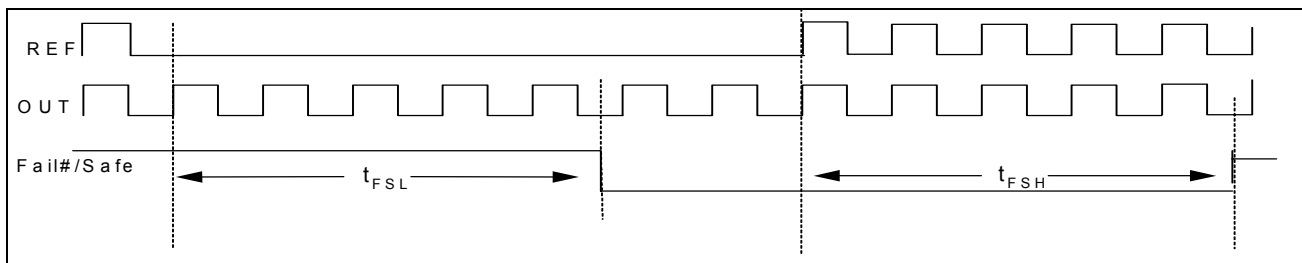
Figure 1. Fail#/Safe Timing for Input Reference Failing Catastrophically
Notes:

1. For normal operation, connect either one of the four clock outputs to the FBK input.
2. Weak pull-downs on all outputs
3. Weak pull-ups on these inputs.
4. Weak pull-down on these inputs.

$$t_{FSL(max)} = 2 (t_{REF} \times n) + 25 ns$$

$$n = \frac{F_{REF}}{F_{XTAL}} = 4 \text{ (in above example)}$$

$$t_{FSH(min)} = 12 (t_{REF} \times n) + 25 ns$$

Figure 2. Fail#/Safe Timing Formula
Table 2. FailSafe Timing Table

Parameter	Description	Conditions	Min.	Max.	Unit
t_{FSL}	Fail#/Safe Assert Delay	Measured at 80% to 20%, Load = 15 pF		See Figure 2	ns
t_{FSH}	Fail#/Safe De-assert Delay	Measured at 80% to 20%, Load = 15 pF	See Figure 2		ns

In this mode, should the reference frequency fail (i.e. stop or disappear), the DCXO maintains its last setting and a flag signal (FAIL#/SAFE) is set to indicate failure of the reference clock.

The CY23FS04 provides 2 select bits, S1 through S2 to control the reference to crystal frequency ratio. The DCXO is internally tuned to the phase and frequency of the external reference

only when the reference frequency divided by this ratio is within the DCXO capture range. If the frequency is out of range, a flag will be set on the FAIL#/SAFE pin notifying the system that the selected reference is not valid. If the reference moves in range, then the flag will be cleared, indicating to the system that the selected reference is valid.

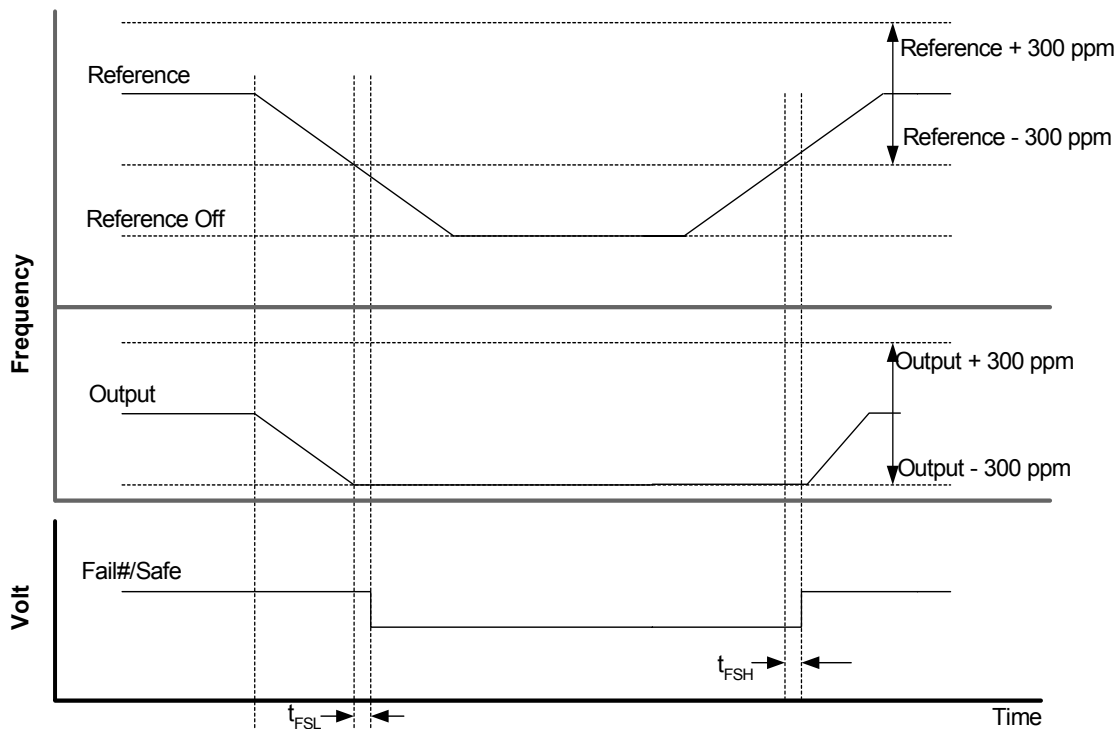
Figure 3. FailSafe Timing Diagram: Input Reference Slowly Drifting Out of FailSafe Capture Range

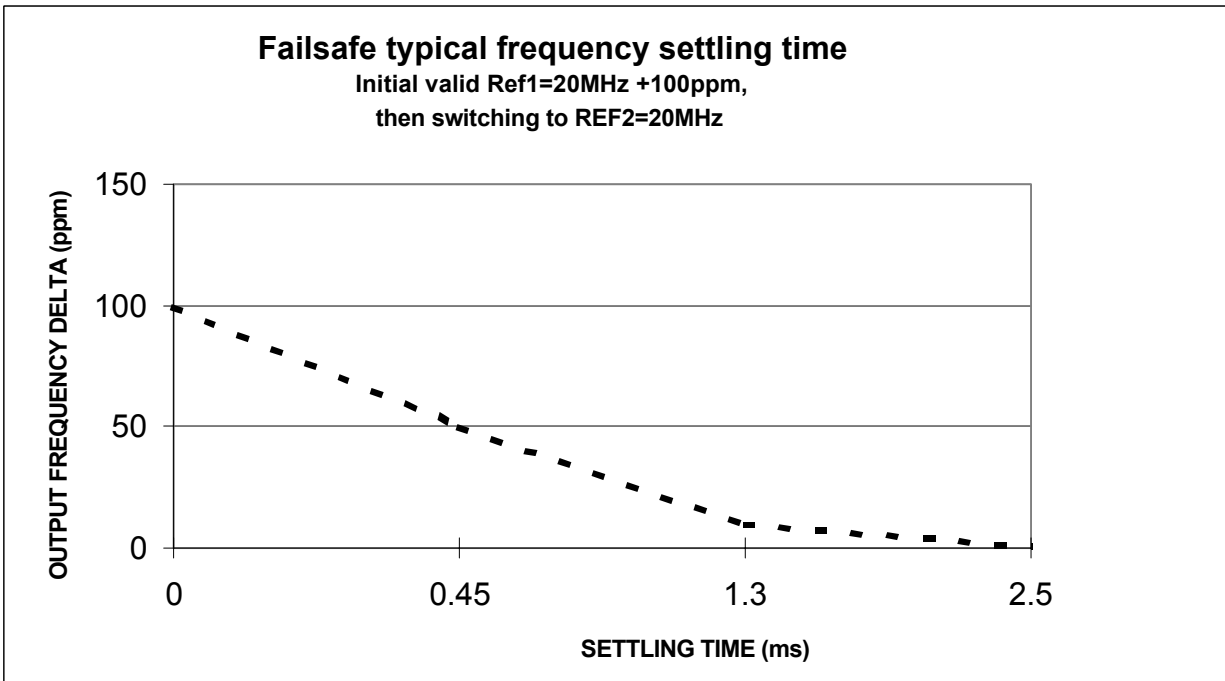

Figure 4. FailSafe Reference Switching Behavior

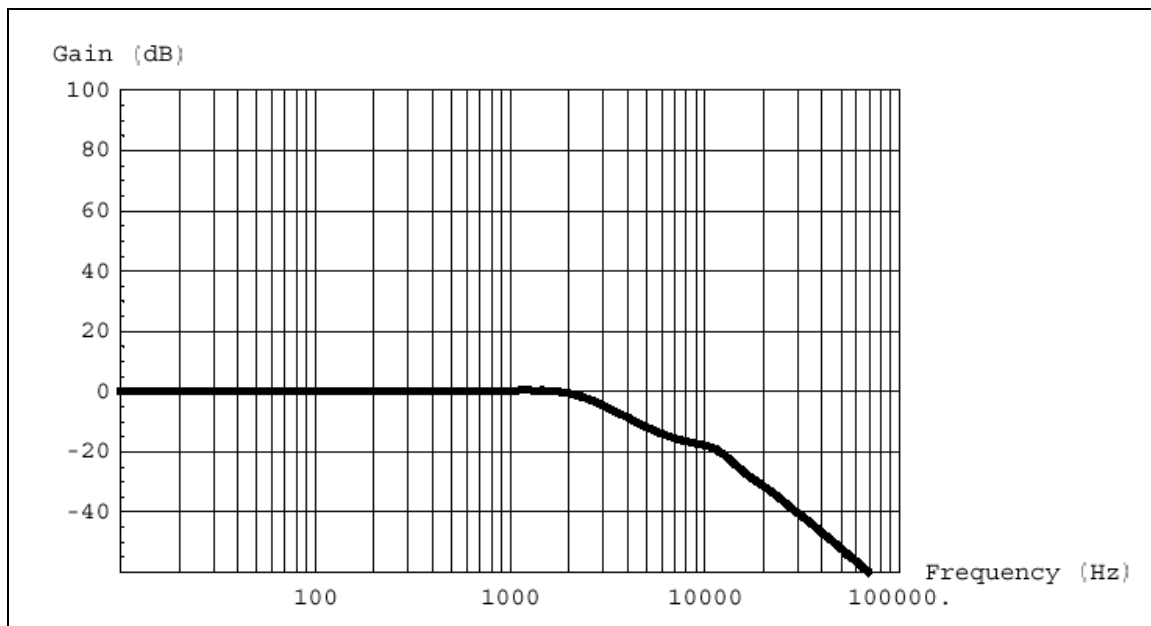

Figure 5. FailSafe Effective Loop Bandwidth (min)

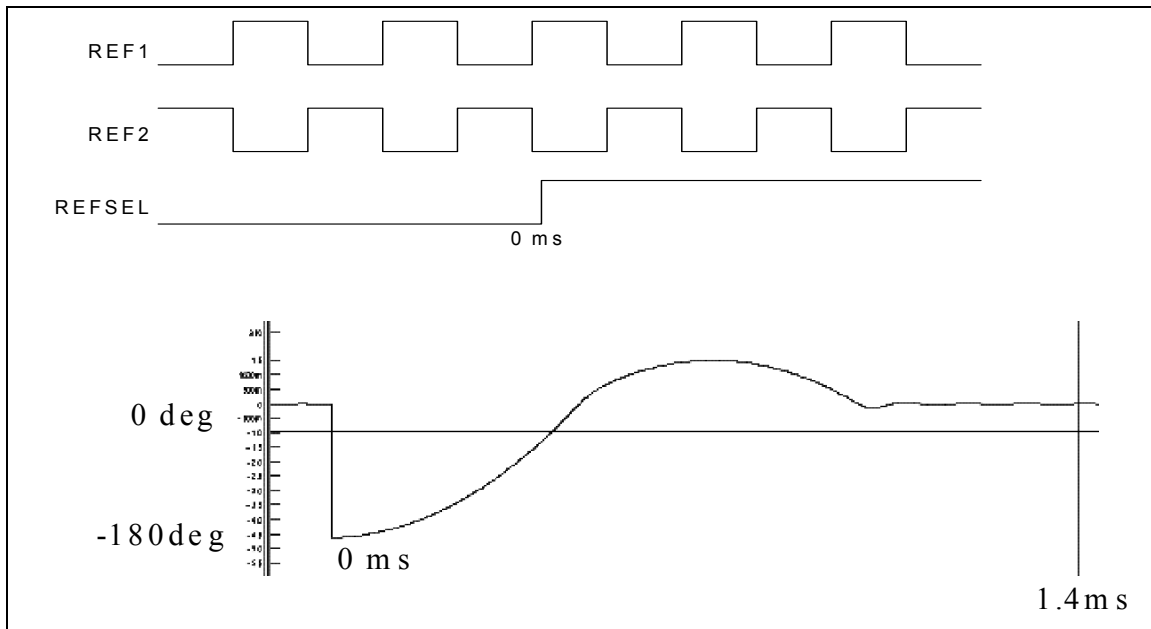

Figure 6. Sample Timing of Muxing Between Two Reference Clocks 180° Out of Phase and Resulting Output Phase Offset Typical Settling Time (105 MHz)

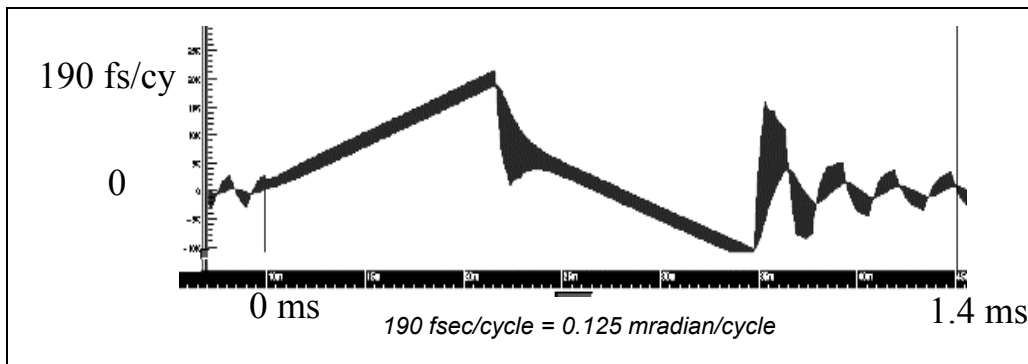
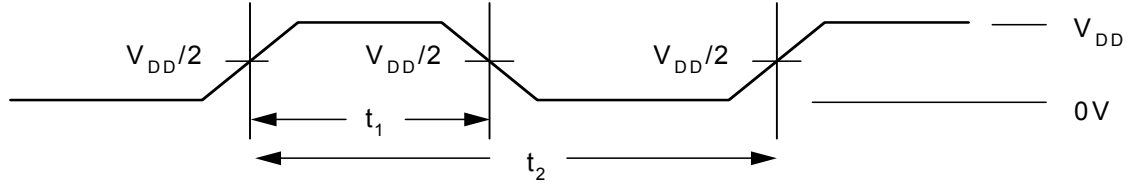
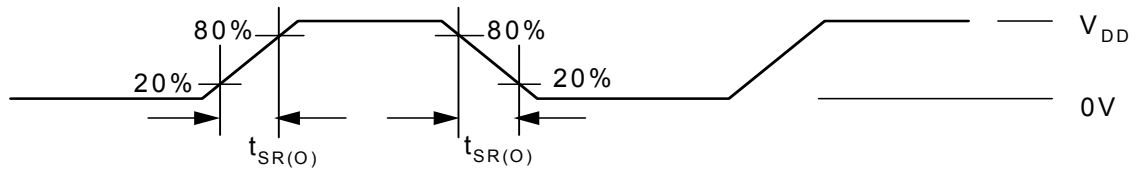
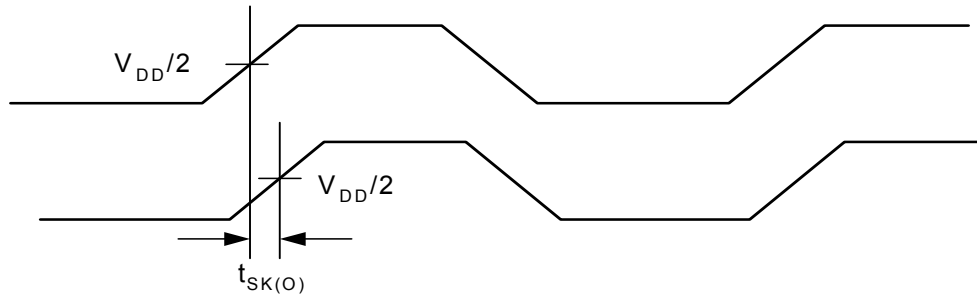
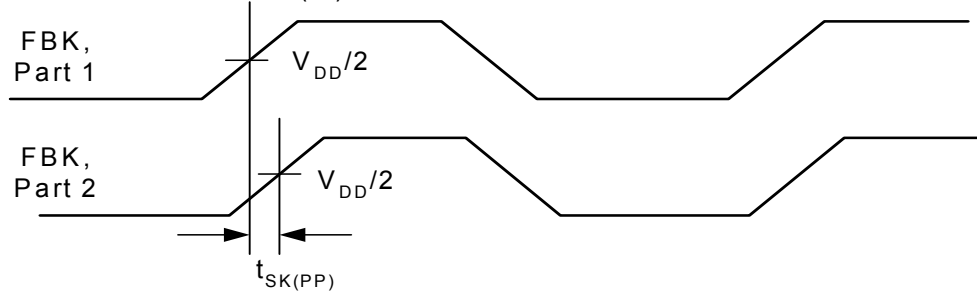
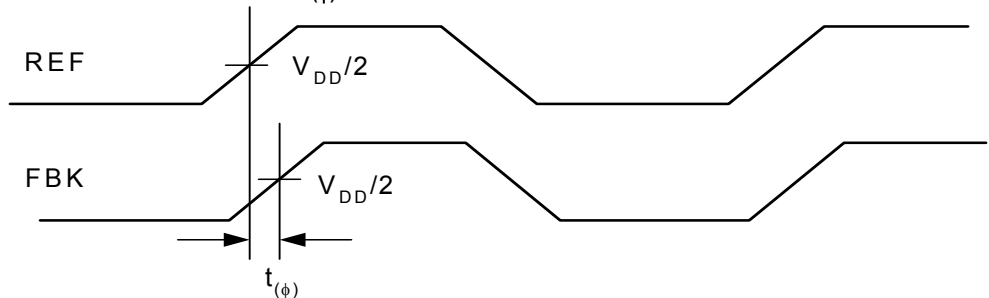

Figure 7. Resulting Output dphase/Cycle Typical Rate of Change (105 MHz)

Duty Cycle - t_{DC}

Slew Rate - t_{SR}

Output-Output Skew - $t_{SK(O)}$

Part to Part Skew - $t_{SK(PP)}$

Static Phase Offset - $t_{(\phi)}$

XTAL Selection Criteria and Application Example

Choosing the appropriate XTAL will ensure the FailSafe device will be able to span an appropriate frequency of operation. Also, the XTAL parameters will determine the holdover frequency stability. Critical parameters are as follows. Our recommendation is to choose:

- Low C0/C1 ratio (240 or less) so that the XTAL has enough range of pullability.
- Low temperature frequency variation
- Low manufacturing frequency tolerance
- Low aging.

C0 is the XTAL shunt capacitance (3 pF – 7 pF typ).

C1 is the XTAL motional capacitance (10 fF – 30 fF typ).

The capacitive load as “seen” by the XTAL is across its terminals. It is named C_{lmin} (for minimum value), and C_{lmax} (for maximum value). These are used for calculating the pull range.

Please note that the C_l range “center” is approximately 20 pF, but we may not want a XTAL calibrated to that load. This is because the pullability is not linear, as represented in the equation above. Plotting the pullability of the XTAL shows this expected behavior as shown in *Figure 8*. In this example, specifying a XTAL calibrated to 14 pF load provides a balanced ppm pullability range around the nominal frequency.

Example:^[5]

$$C_{lmin} = (12 \text{ pF IC input cap} + 0 \text{ pF pulling cap} + 6 \text{ pF trace cap on board})/2 = 9 \text{ pF}$$

$$C_{lmax} = (12 \text{ pF IC input cap} + 48 \text{ pF pulling cap} + 6 \text{ pF trace cap on board})/2 = 33 \text{ pF}$$

$$\text{Pull Range} = (f_{Clmin} - f_{Clmax})/f_{Clmin} = ((C1)/2)[(1/(C0+Clmin)) - (1/(C0+Clmax))]$$

$$\text{Pull Range in ppm} = ((C1)/2)[(1/(C0+Clmin)) - (1/(C0+Clmax))] \times 10^6$$

Note:

5. The above example shows the maximum range the FailSafe internal capacitor array is capable of (0 to 48.6 pF). Cypress recommends the min/max capacitor array values be programmed to a narrower range such as 6 pF–30 pF, or 7.5 pF–27 pF. This ensures the XTAL operates between series resonance and anti-resonance. Please contact Cypress for choosing these range settings.

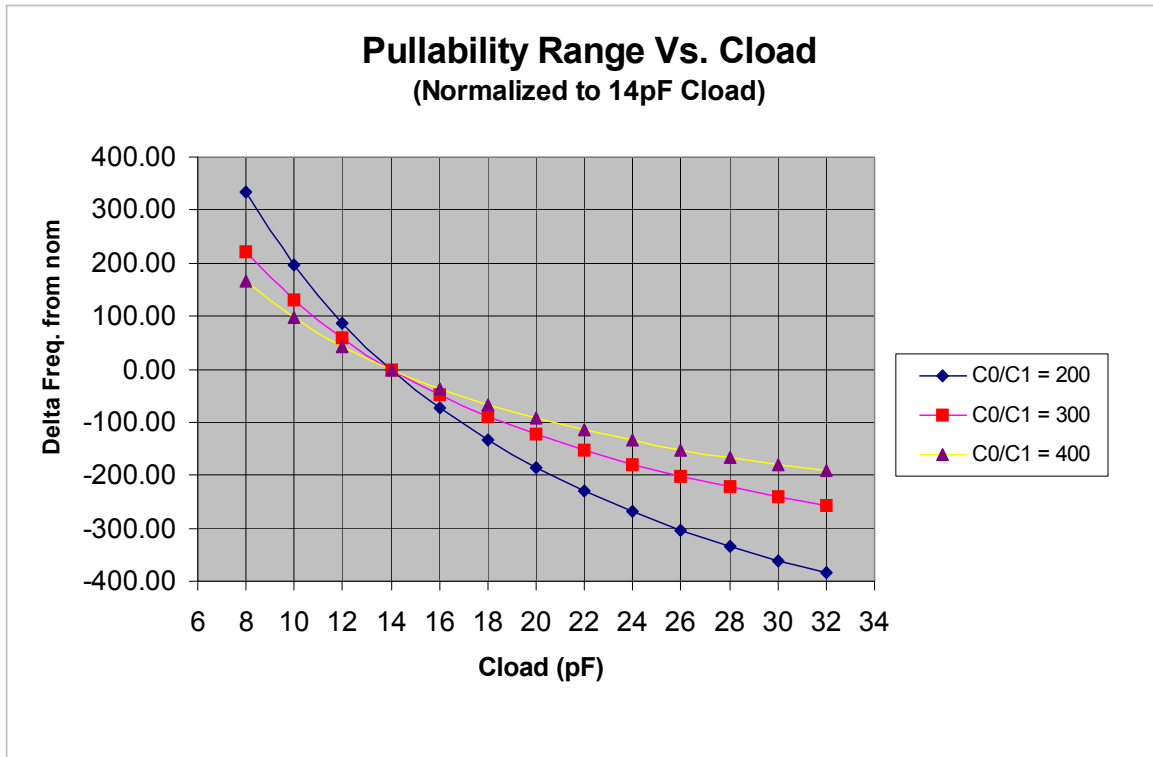

Figure 8. Frequency vs. Cloud Behavior for Example XTAL

Table 3. Pullability Range fro XTAL with Different C0/C1 Ratio

C0/C1 Ratio	Cloud(min.)	Cloud(max.)	Pullability Range	
			Min	Max
200	8.0	32.0	-385	333
300	8.0	32.0	-256	222
400	8.0	32.0	-192	166

Calculated value of the pullability range for the XTAL with C0/C1 ratio of 200, 300 and 400 are shown in Table 3. For this calculation Cl(min) = 8 pF and Cl(max)= 32 pF has been used. Using a XTAL that has a nominal frequency specified at load capacitance of 14 pF, almost symmetrical pullability range has been obtained.

Next, it is important to calculate the pullability range including error tolerances. This would be the **capture range** of the input reference frequency that the FailSafe device and XTAL combination would reliably span.

Calculating the **capture range** involves subtracting error tolerances as follows:

Parameter	f error (ppm)
Manufacturing frequency tolerance	15
Temperature stability	30
Aging	3
Board / trace variation	5
Total	53

Example: Capture Range for XTAL with C0/C1 Ratio of 200

Negative Capture Range= -385 ppm + 53 ppm = -332 ppm

Positive Capture Range = 333 ppm – 53 ppm = +280 ppm

It is important to note that the XTAL with lower C0/C1 ratio has wider **pullability/capture range** as compared to the higher C0/C1 ratio. This will help the user in selecting the appropriate XTAL for use in the FailSafe application.

Absolute Maximum Conditions

Parameter	Description	Condition	Min.	Max.	Unit
V _{DD}	Supply Voltage		-0.5	4.6	V
V _{IN}	Input Voltage	Relative to V _{SS}	-0.5	V _{DD} +0.5	VDC
T _S	Temperature, Storage	Non Functional	-65	+150	°C
T _A	Temperature, Operating Ambient	Commercial Grade	0	70	°C
		Industrial Grade	-40	85	°C
T _J	Temperature, Junction	Functional		125	°C
ESD _{HBM}	ESD Protection (Human Body Model)	MIL-STD-883, Method 3015	2000		V
∅ _{JC}	Dissipation, Junction to Case	Mil-Spec 883E Method 1012.1	29.87		°C/W
∅ _{JA}	Dissipation, Junction to Ambient	JEDEC (JESD 51)	120.11		°C/W
UL-94	Flammability Rating	At 1/8 in.	V-0		
MSL	Moisture Sensitivity Level		1		

Multiple Supplies: The Voltage on any input or I/O pin cannot exceed the power pin during power-up. Power supply sequencing is NOT required.

Recommended Pullable Crystal Specifications^[6]

Parameter	Name	Comments	Min.	Typ.	Max.	Unit
F _{NOM}	Nominal crystal frequency	Parallel resonance, fundamental mode, AT cut	8.00	-	30.00	MHz
C _{LNOM}	Nominal load capacitance		-	14	-	pF
R ₁	Equivalent series resistance (ESR)	Fundamental mode	-	-	25	Ω
R ₃ /R ₁	Ratio of third overtone mode ESR to fundamental mode ESR	Ratio used because typical R ₁ values are much less than the maximum spec	3	-	-	
DL	Crystal drive level	No external series resistor assumed	-	0.5	2	mW
F _{3SEPLI}	Third overtone separation from 3*F _{NOM}	High side	300	-	-	ppm
F _{3SEPLO}	Third overtone separation from 3*F _{NOM}	Low side	-	-	-150	ppm
C ₀	Crystal shunt capacitance		-	-	7	pF
C ₀ /C ₁	Ratio of shunt to motional capacitance		180	-	250	
C ₁	Crystal motional capacitance		14.4	18	21.6	fF

Table 4. Operating Conditions for FailSafe Commercial/Industrial Temperature Devices

Parameter	Description	Min.	Max.	Unit
V _{DDC}	3.3V Supply Voltage	3.135	3.465	V
V _{DD}	2.5V Supply Voltage Range	2.375	2.625	V
	3.3V Supply Voltage Range	3.135	3.465	V
T _A	Ambient Operating Temperature, Commercial	0	70	°C
	Ambient Operating Temperature, Industrial	-40	85	°C
C _L	Output Load Capacitance (F _{out} ≤ 100 MHz)		30	pF
	Output Load Capacitance (F _{out} > 100 MHz)		15	pF
C _{IN}	Input Capacitance (except XIN)		7	pF
C _{XIN}	Crystal Input Capacitance (all internal caps off)	10	13	pF
T _{PU}	Power-up time for all VDDs to reach minimum specified voltage (power ramps must be monotonic)	0.05	500	ms

Note:

6. Ecliptek ECX-5788-13.500M, ECX-5807-19.440M, ECX-5872-19.53125M, ECX-5806-18.432M, ECX-5808-27.000M, ECX-5884-17.664M, ECX-5883-16.384M, ECX-5882-19.200M, ECX-5880-24.576M meet these specifications.

Table 5. Electrical Characteristics for FailSafe Commercial/Industrial Temperature Devices

Parameter	Description	Test Conditions	Min.	Typ.	Max.	Unit
V _{IL}	Input Low Voltage	CMOS Levels, 30% of V _{DD}			0.3 × V _{DD}	V
V _{IH}	Input High Voltage	CMOS Levels, 70% of V _{DD}	0.7 × V _{DD}			V
I _{IL}	Input Low Current	V _{IN} = V _{SS} (100k pull-up only)			50	μA
I _{IH}	Input High Current	V _{IN} = V _{DD} (100k pull-down only)			50	μA
I _{OL}	Output Low Current	V _{OL} = 0.5V, V _{DD} = 2.5V		18		mA
		V _{OL} = 0.5V, V _{DD} = 3.3V		20		mA
I _{OH}	Output High Current	V _{OH} = V _{DD} - 0.5V, V _{DD} = 2.5V		18		mA
		V _{OH} = V _{DD} - 0.5V, V _{DD} = 3.3V		20		mA
I _{DDQ}	Quiescent Current	All inputs grounded, PLL and DCXO in bypass mode, Reference Input = 0			250	μA

Table 6. Switching Characteristics for FailSafe Commercial/Industrial Temperature Devices

Parameter ^[8]	Description	Test Conditions	Min.	Max.	Unit
f _{REF}	Reference Frequency	Commercial/Industrial Grades	4.17	170	MHz
f _{OUT}	Output Frequency	15-pF Load, Commercial/Industrial Grades	4.17	170	MHz
f _{XIN}	DCXO Frequency		8.0	30	MHz
t _{DC}	Duty Cycle	Measured at V _{DD} /2	47	53	%
t _{SR(I)}	Input Slew Rate	Measured on REF1 Input, 30% to 70% of V _{DD}	0.5	4.0	V/ns
t _{SR(O)}	Output Slew Rate	Measured from 20% to 80% of V _{DD} = 3.3V, 15 pF Load	0.8	4.0	V/ns
		Measured from 20% to 80% of V _{DD} = 2.5V, 15 pF Load	0.4	3.0	V/ns
t _{SK(O)}	Output to Output Skew	All outputs equally loaded, measured at V _{DD} /2		200	ps
t _{SK(PP)}	Part to Part Skew	Measured at V _{DD} /2		500	ps
t _(φ) ^[7]	Static Phase Offset	Measured at V _{DD} /2		250	ps
t _{D(φ)} ^[7]	Dynamic Phase Offset	Measured at V _{DD} /2		200	ps
t _{J(CC)}	Cycle-to-cycle Jitter	Load = 15 pF, f _{OUT} ≥ 6.25 MHz		200	ps
				35	ps _{RMS}

Ordering Information

Part Number	Package Type	Product Flow
CY23FS04ZI	16-Pin TSSOP	Industrial, -40°C to 85°C
CY23FS04ZIT	16-Pin TSSOP – Tape and Reel	Industrial, -40°C to 85°C
CY23FS04ZC	16-Pin TSSOP	Commercial, 0°C to 70°C
CY23FS04ZCT	16-Pin TSSOP – Tape and Reel	Commercial, 0°C to 70°C

Notes:

- The t_(φ) reference feedback input delay is guaranteed for a maximum 4:1 input edge ratio between the two signals as long as t_{SR(I)} is maintained.
- Parameters guaranteed by design and characterization, not 100% tested in production.
- Includes typical board trace capacitance of 6–7pF each XIN, XOUT.

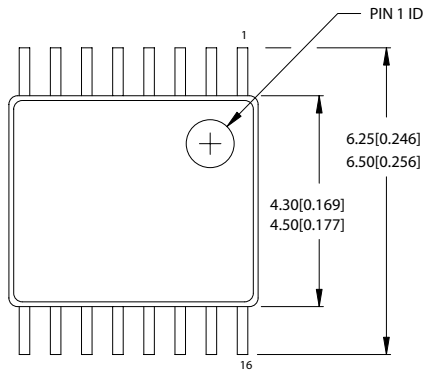
Package Drawing and Dimensions
16-lead TSSOP 4.40 MM Body Z16.173

DIMENSIONS IN MM[INCHES] MIN.
MAX.

REFERENCE JEDEC MO-153

PACKAGE WEIGHT 0.05 gms

PART #	
Z16.173	STANDARD PKG.
ZZ16.173	LEAD FREE PKG.

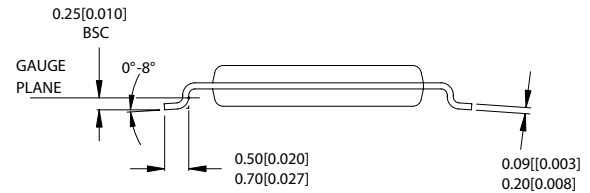
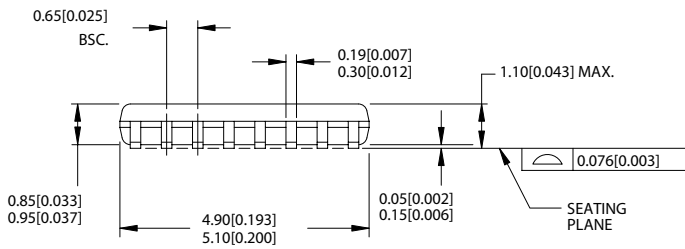

51-85091-*A

FailSafe is a trademark of Cypress Semiconductor. All product and company names mentioned in this document are the trademarks of their respective holders.



Document History Page

Document Title: CY23FS04 Failsafe™ 2.5V/ 3.3V Zero Delay Buffer				
Document #: 38-07304 Rev. *B				
REV.	ECN NO.	Issue Date	Orig. of Change	Description of Change
**	123698	04/24/03	RGL	New data sheet
*A	223811	See ECN	RGL/ZJX	Changed the XTAL Specifications table.
*B	276712	See ECN	RGL	Removed (T _{LOCK})Lock Time Specification