

# YG805C04(20A)

查询YG805C04供应商

捷多邦, 专业PCB打样工厂, 24小时加急出货

富士小電力ダイオード

## ショットキーバリアダイオード

### SCHOTTKY BARRIER DIODE

## ■外形寸法：Outline Drawings

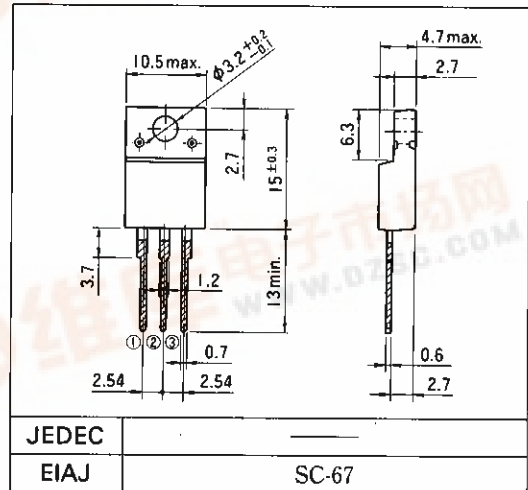

## ■特長：Features

- 取り付け面が絶縁されたフルモールドタイプ  
Insulated package by fully molding.
- 低 $V_F$   
Low  $V_F$
- スイッチングスピードが非常に速い  
Super high speed switching.
- プレーナー技術による高信頼性  
High reliability by planer design.

## ■用途：Applications

- 高速電力スイッチング  
High speed power switching.

## ■電極接続

### Connection Diagram

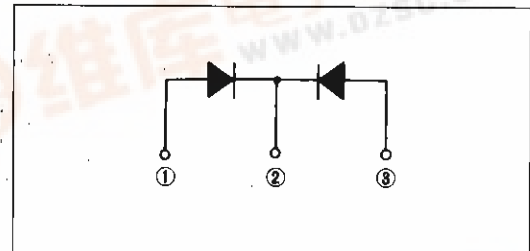

## ■定格と特性：Maximum Ratings and Characteristics

### ●絶対最大定格：Absolute Maximum Ratings

Items	Symbols	Conditions	Ratings	Units
ピーク繰り返し逆電圧 Repetitive Peak Reverse Voltage	$V_{RRM}$		40	V
ピーク非繰り返し逆電圧 Non-Repetitive Peak Reverse Voltage	$V_{RSM}$	$t_w = 500\text{ns}$ , $\text{duty} = \frac{1}{10}$	48	V
絶縁耐圧 Isolating Voltage	$V_{ISO}$	一括端子・ケース間, AC1分間印加 Terminals-to-Case, AC, 1 min.	1500	V
平均出力電流 Average Output Current	$I_O$	方形波, $\text{duty} = \frac{1}{2}$ , $T_c = 83^\circ\text{C}$ Square wave	20*	A
サージ電流 Surge Current	$I_{FSM}$	正弦波 Sine wave 10ms 定格負荷状態より	120	A
接合温度 Operating Junction Temperature	$T_j$		-40 ~ +125	$^\circ\text{C}$
保存温度 Storage Temperature	$T_{stg}$		-40 ~ +125	$^\circ\text{C}$

\* センタータップ平均出力電流

\* average forward current of centertap full wave connection

### ●電気的特性(特に指定がない限り周囲温度 $T_a = 25^\circ\text{C}$ とする)

Electrical Characteristics ( $T_a = 25^\circ\text{C}$  Unless otherwise specified)

Items	Symbols	Conditions	Max.	Units
順電圧 Forward Voltage Drop	$V_{FM}$	$I_{FM} = 10\text{A}$	0.6	V
逆電流 Reverse Current	$I_{RRM}$	$V_R = V_{RRM}$	15	mA
熱抵抗 Thermal Resistance	$R_{th(j-c)}$	接合・ケース間 Junction to case	2.5	$^\circ\text{C}/\text{W}$



■特性曲線：Characteristics

A

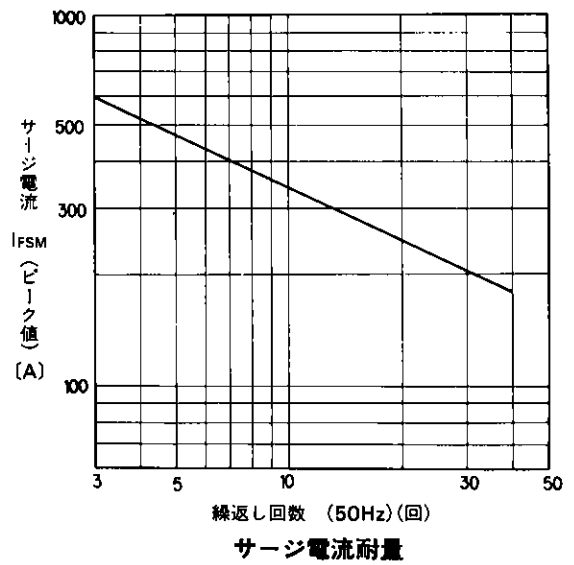
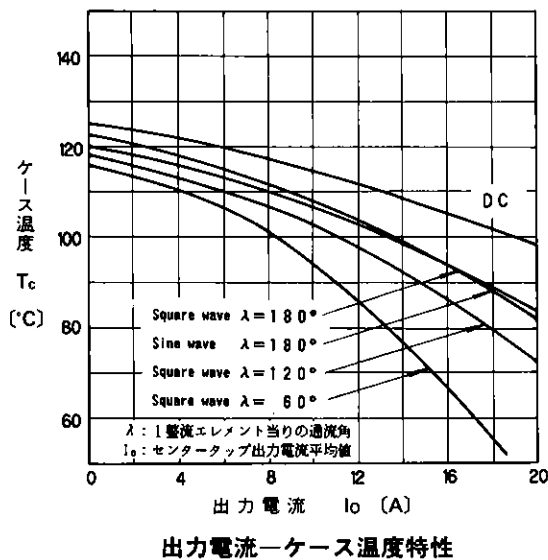
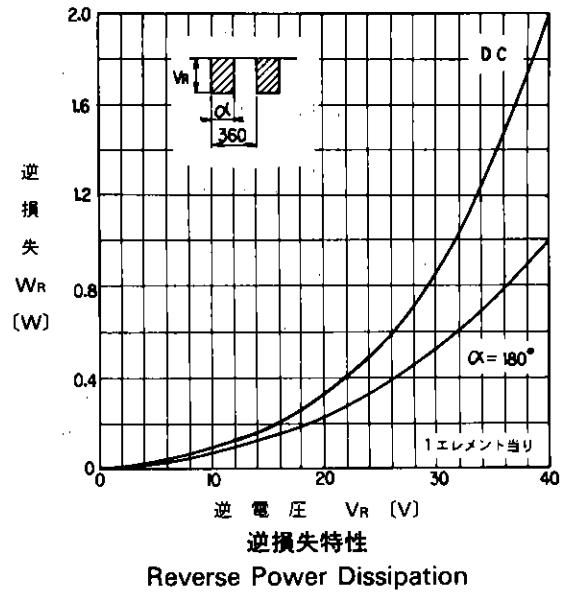
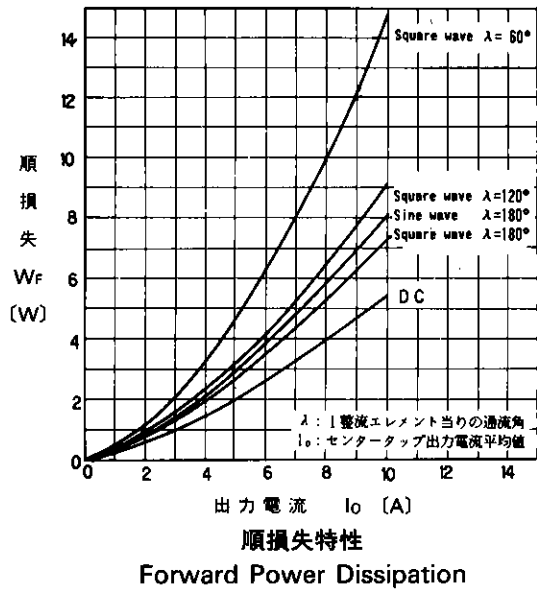
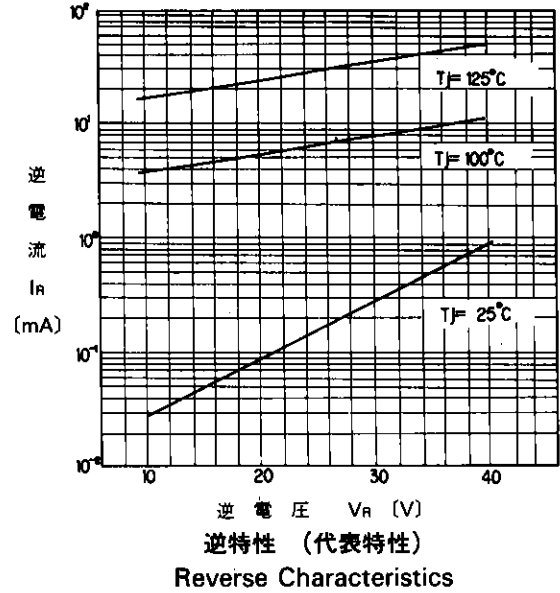
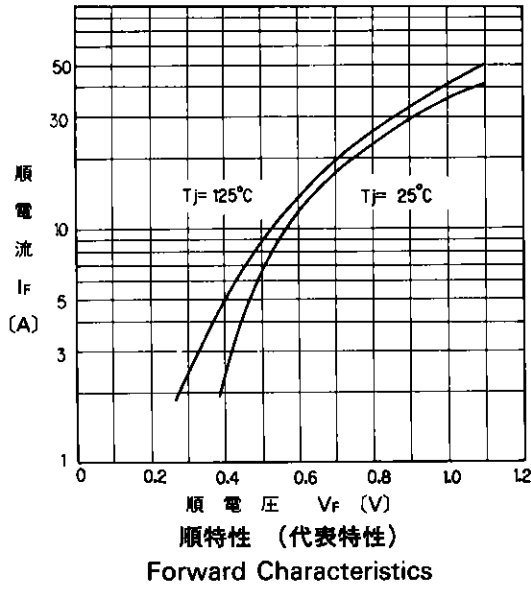

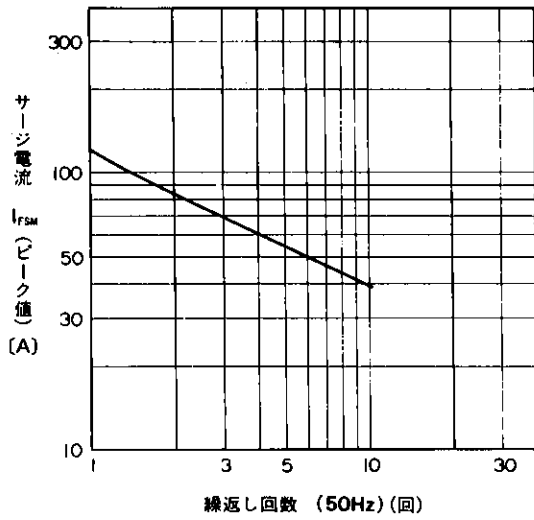

サージ電流耐量  
Surge Capability

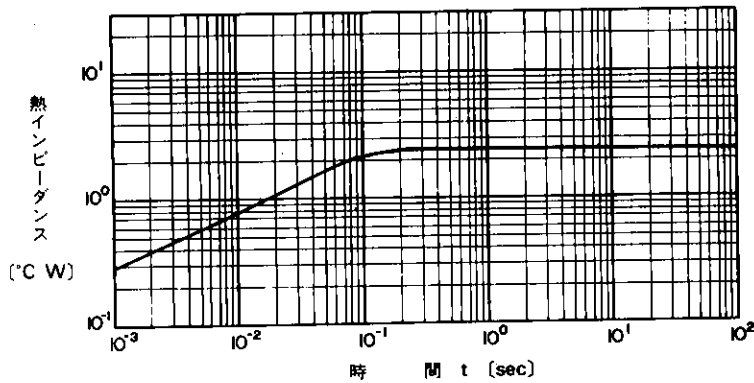

過渡熱インピーダンス  
Transient Thermal Impedance

For more information, contact:

**Collmer Semiconductor, Inc.**

P.O. Box 702708

Dallas, TX 75370

972-733-1700

972-381-9991 Fax

<http://www.collmer.com>