



## PolyZen Devices

### Polymer Protected Zener Diode

PolyZen devices are polymer enhanced precision Zener diode micro-assemblies that help protect sensitive electronics from damage caused by inductive voltage spikes, voltage transients, use of incorrect power supplies and reverse bias.

The PolyZen micro-assembly incorporates a stable Zener diode for precise voltage clamping and a resistively non-linear, polymeric positive temperature coefficient (PPTC) layer that responds to either diode heating or overcurrent events by transitioning from a low to high resistance state.

PolyZen devices help provide resettable protection against damage caused by multi-watt fault events and require only 0.7W power dissipation. In the event of sustained high power conditions, the PPTC element of the device “trips” to limit current and generate voltage drop. This functionality helps protect both the Zener and the follow-on electronics, effectively increasing the diode’s power handling capacity.



#### Benefits

- Helps shield downstream electronics from overvoltage and reverse bias
- Trip events shut out overvoltage and reverse bias sources
- Analog nature of trip events minimize upstream inductive spikes
- Helps reduce design costs with single component placement and minimal heat sinking requirements

#### Applications

- Portable media players
- Global positioning systems
- Hard disk drives 5V & 12V bus
- Solid State Drives (SSD) 5V bus

#### Features

- RoHS compliant
- Overvoltage transient suppression
- Hold currents up to 2.3A
- Time delayed, overvoltage trip
- Time delayed, reverse bias trip
- Power handling on the order of 30 watts
- Integrated device construction

- Cellphone charger port and USB power
- Automotive peripheral input power
- DC power port protection
- Industrial handheld POS

**Figure PZ1 Typical Application Block Diagram for PolyZen Devices**

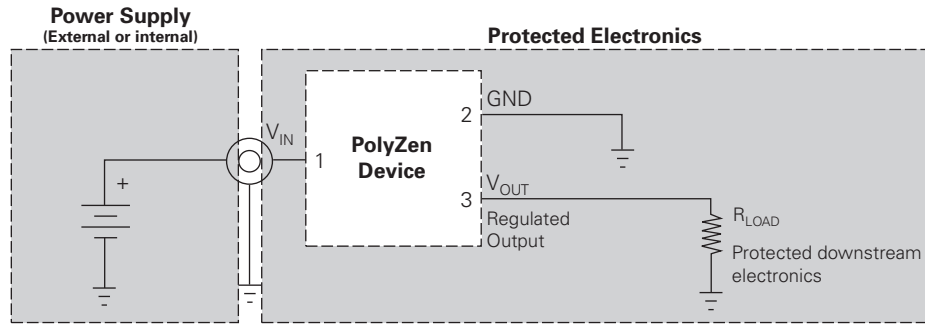

**Table PZ1 Electrical Characteristics for PolyZen Devices**

(Performance ratings @ 25°C unless otherwise specified)

| Part Number                                     | V <sub>Z</sub> (V) |      |       | I <sub>Zt</sub> (A) | I <sub>HOLD</sub> @ 20°C (A) | R <sub>Typ</sub> (Ω) | R <sub>1MAX</sub> (Ω) | V <sub>INT MAX</sub>     |                  | I <sub>FLT MAX</sub>     |                  |
|---|--------------------|------|-------|---------------------|------------------------------|----------------------|-----------------------|--------------------------|------------------|--------------------------|------------------|
|   | Min.               | Typ. | Max.  |                     |                              |                      |                       | V <sub>INT MAX</sub> (V) | Test Current (A) | I <sub>FLT MAX</sub> (A) | Test Voltage (V) |
| ZEN056V130A24LS                                 | 5.45               | 5.6  | 5.75  | 0.1                 | 1.3                          | 0.12                 | 0.16                  | 24V                      | 3A               | +10/-40                  | +24/-16V         |
| ZEN065V130A24LS                                 | 6.35               | 6.5  | 6.65  | 0.1                 | 1.3                          | 0.12                 | 0.16                  | 24V                      | 3A               | +6/-40                   | +24/-16V         |
| <b>NEW</b> ZEN098V130A24LS                      | 9.60               | 9.8  | 10.00 | 0.1                 | 1.3                          | 0.12                 | 0.16                  | 24V                      | 3A               | +3.5/-40                 | +24/-16V         |
| ZEN132V130A24LS                                 | 13.20              | 13.4 | 13.60 | 0.1                 | 1.3                          | 0.12                 | 0.16                  | 24V                      | 3A               | +2/-40                   | +24/-16V         |
| ZEN164V130A24LS                                 | 16.10              | 16.4 | 16.60 | 0.1                 | 1.3                          | 0.12                 | 0.16                  | 24V                      | 3A               | +1.25/-40                | +24/-16V         |
| ZEN056V230A16LS                                 | 5.45               | 5.6  | 5.75  | 0.1                 | 2.3                          | 0.04                 | 0.06                  | 16V                      | 5A               | +5/-40                   | +16/-12V         |
| ZEN065V230A16LS                                 | 6.35               | 6.5  | 6.65  | 0.1                 | 2.3                          | 0.04                 | 0.06                  | 16V                      | 5A               | +3.5/-40                 | +16/-12V         |
| ZEN132V230A16LS                                 | 13.20              | 13.4 | 13.60 | 0.1                 | 2.3                          | 0.04                 | 0.06                  | 16V                      | 5A               | +2/-40                   | +20/-12V         |
| ZEN056V075A48LS                                 | 5.45               | 5.6  | 5.75  | 0.1                 | 0.75                         | 0.28                 | 0.45                  | 48V                      | 3A               | +10/-40                  | +48/-16V         |
| ZEN132V075A48LM                                 | 13.20              | 13.4 | 13.60 | 0.1                 | 0.75                         | 0.28                 | 0.45                  | 48V                      | 3A               | +2/-40                   | +48/-16V         |
| <b>NEW</b> ZEN056V115A24LS                      | 5.45               | 5.6  | 5.75  | 0.1                 | 1.15                         | 0.15                 | 0.18                  | 24V                      | 3A               | +10/-40                  | +24/-16V         |
| <b>NEW</b> ZEN056V130A24GS                      | 5.45               | 5.6  | 5.75  | 0.1                 | 1.30                         | 0.12                 | 0.18                  | 24V                      | 3A               | +6/-40                   | +24/-16V         |
| <b>Coming Soon</b> ZEN059V130A24LS <sup>†</sup> | 5.80               | 5.9  | 6.00  | 0.1                 | 1.30                         | 0.12                 | 0.16                  | 24V                      | 3A               | +6/-40                   | +24/-16V         |

\* Data is preliminary

† Maximum Reverse Leakage Current = 650µA@5.0V meets USB suspend mode specification

**Table PZ2 Definitions of Terms for PolyZen Devices**

|                      |  |
|----------------------|--|
| V <sub>Z</sub>       | Zener clamping voltage measured at current I <sub>Zt</sub> and 20°C.   |
| I <sub>Zt</sub>      | Test current at which V <sub>Z</sub> is measured.  |
| I <sub>HOLD</sub>    | Maximum steady state current I <sub>PTC</sub> that will not generate a trip event at the specified temperature. Ratings assume I <sub>FLT</sub> = 0A.  |
| R <sub>Typ</sub>     | Typical resistance between V <sub>IN</sub> and V <sub>OUT</sub> pins when the device is at room temperature.   |
| R <sub>1MAX</sub>    | The maximum resistance between V <sub>IN</sub> and V <sub>OUT</sub> pins, at room temperature, one hour after first trip or after reflow soldering.  |
| I <sub>FLT</sub>     | Current flowing through the Zener diode.   |
| I <sub>FLT MAX</sub> | Maximum RMS fault current the Zener diode component of the device can withstand and remain resettable; testing is conducted at rated voltage with no load connected to V <sub>OUT</sub> .  |
| V <sub>INT MAX</sub> | The voltage (V <sub>IN</sub> - V <sub>OUT</sub> "post trip") at which typical qualification devices (98% devices, 95% confidence) survived at least 100 trip cycles and 24 hours trip endurance when "tripped" at the specified voltage and current (I <sub>PTC</sub> ). |
| Trip Event           | A condition where the PPTC transitions to a high resistance state, thereby limiting I <sub>PTC</sub> , and significantly increasing the voltage drop between V <sub>IN</sub> and V <sub>OUT</sub> .  |

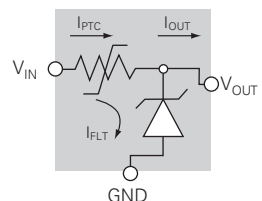
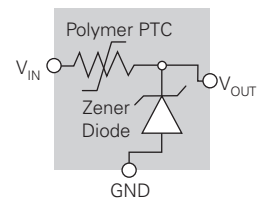

Figure PZ2-PZ9 Typical Performance Curves for PolyZen Devices

Figure PZ2

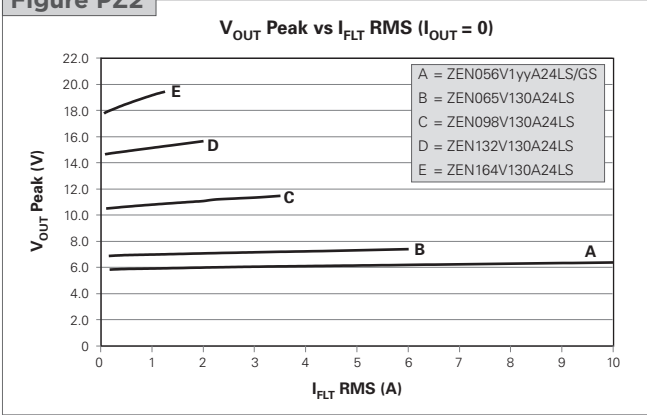

Figure PZ3

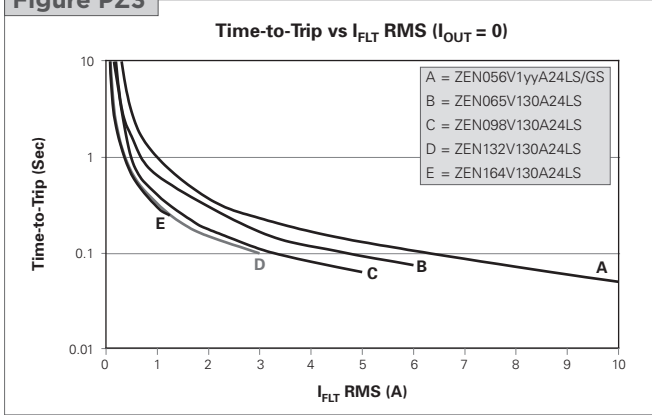

Figure PZ4

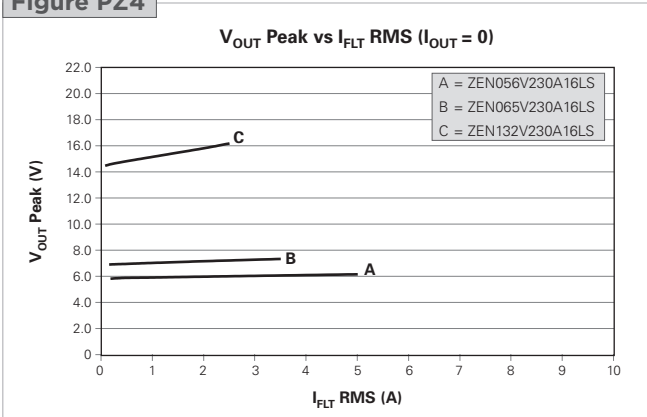

Figure PZ5

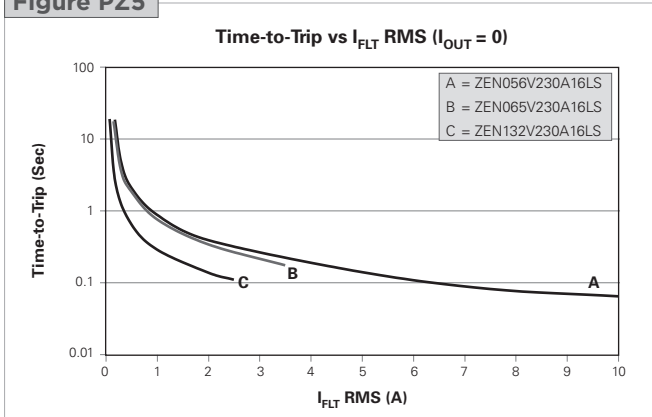

Figure PZ6

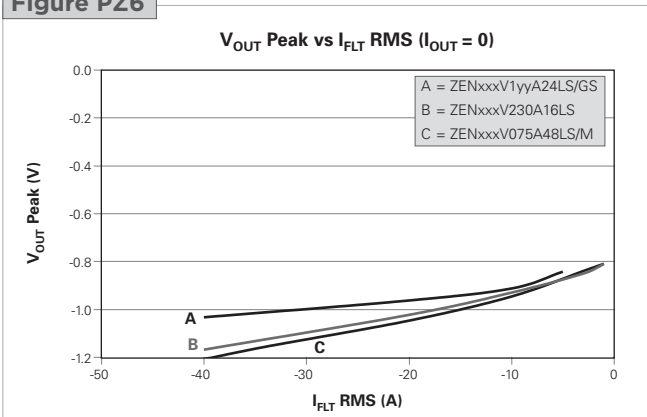

Figure PZ7

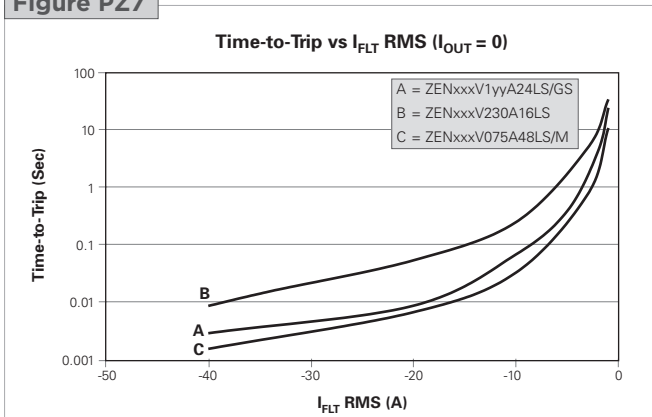

Figure PZ8

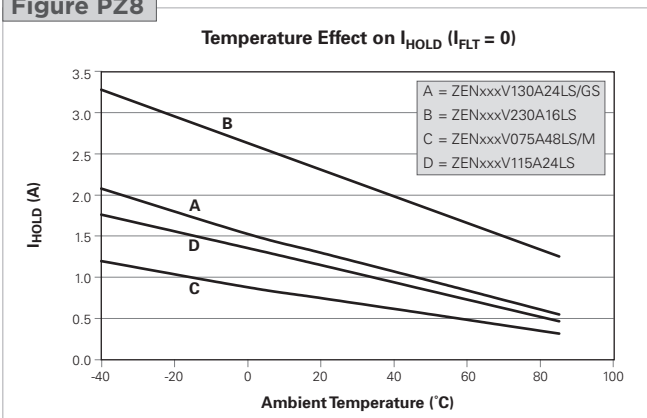
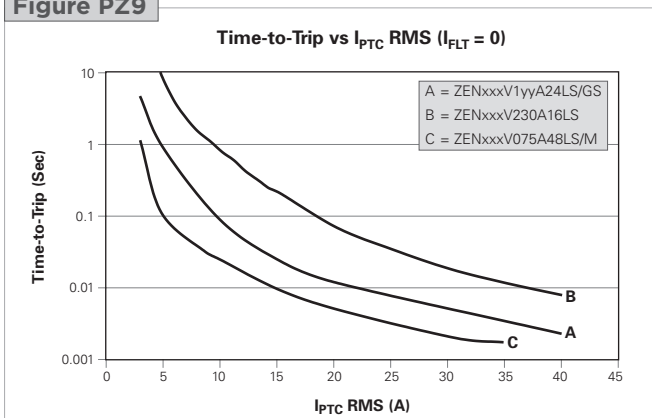

Figure PZ9

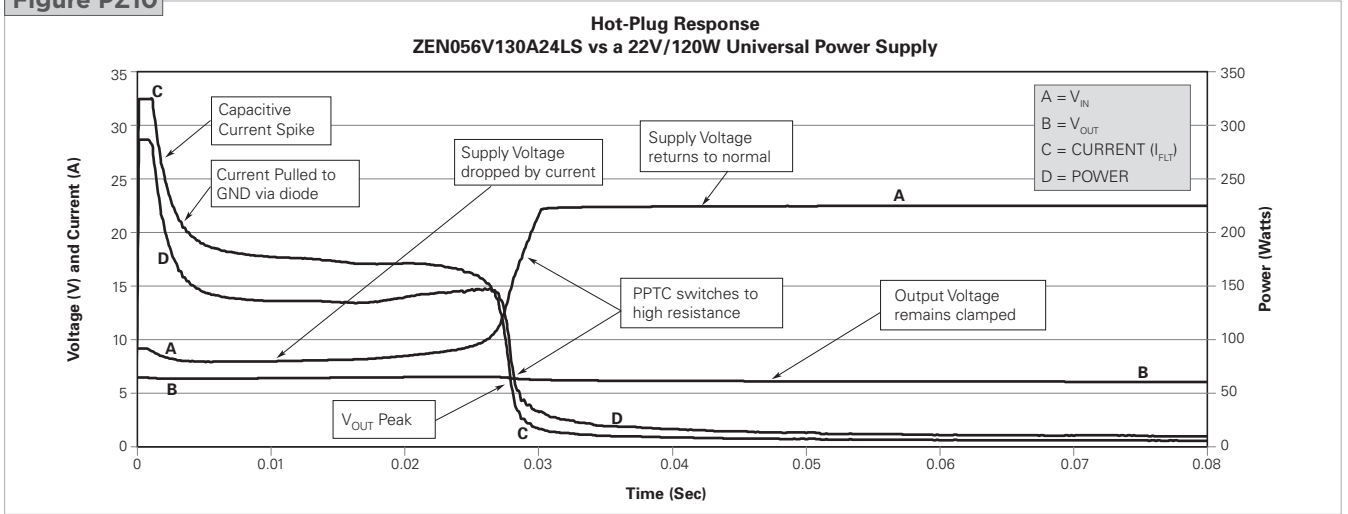

**Table PZ3 General Characteristics for PolyZen Devices**

|                             |                |                        |
|-----------------------------|----------------|------------------------|
| Operating temperature range | -40° to +85°C  |                        |
| Storage temperature         | -40° to +85°C  |                        |
| ESD withstand               | 15kV           | Human body model       |
| Diode capacitance           | 4200pF         | Typical @ 1MHz, 1V RMS |
| Construction                | RoHS compliant |                        |

**Figure PZ10-PZ22 Basic Operation Examples for PolyZen Devices**

**Figure PZ10**



**Figure PZ11**

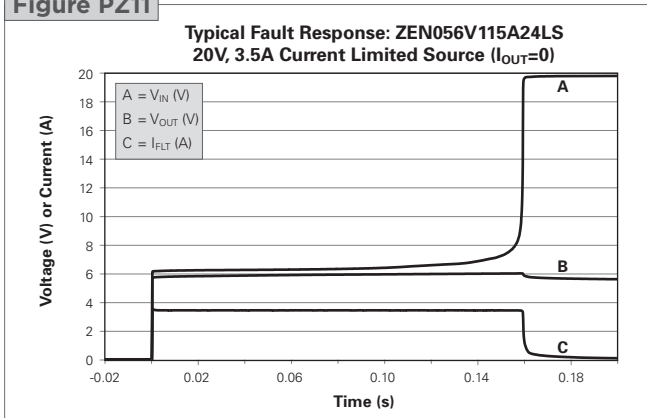

**Figure PZ12**

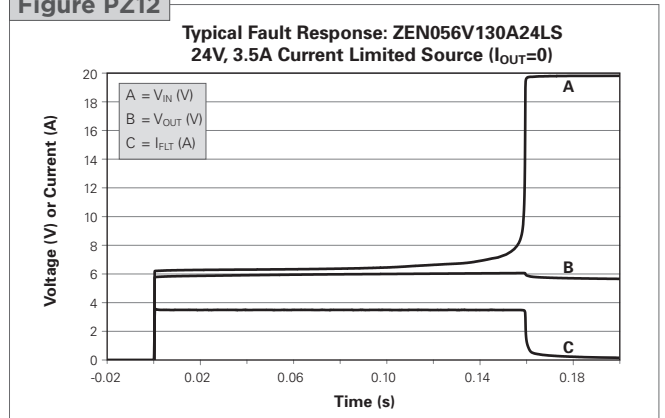

**Figure PZ13**

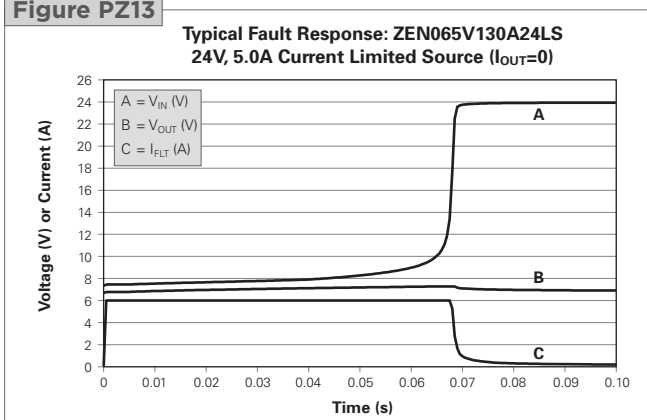

**Figure PZ14**

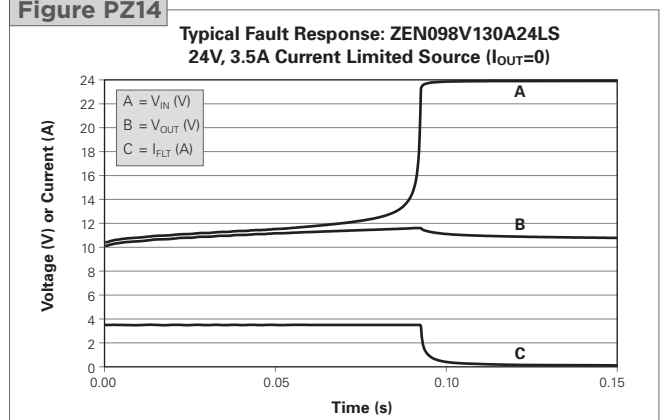
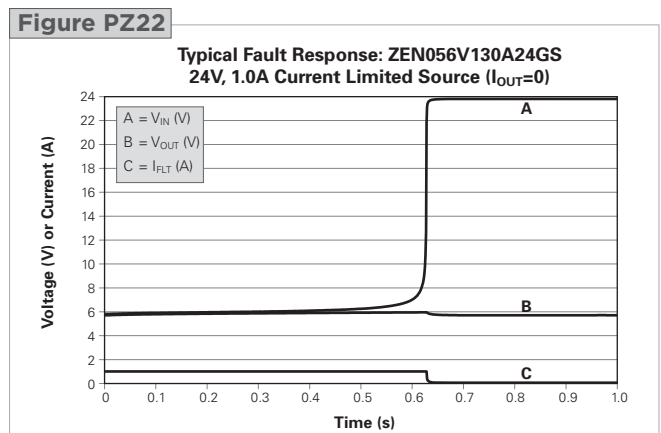
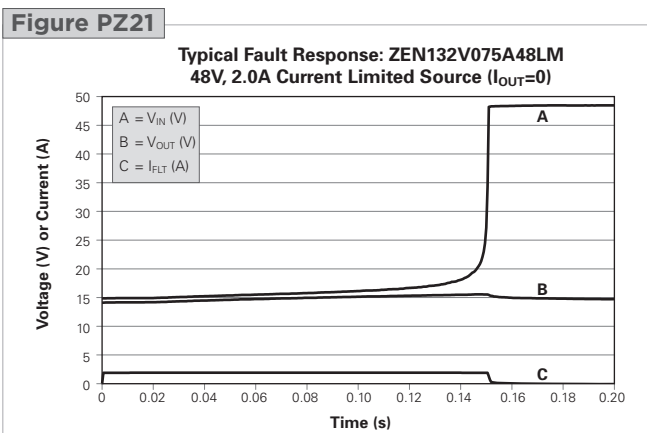
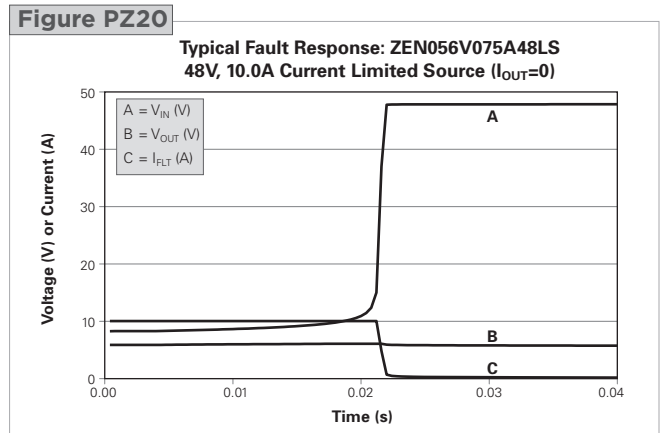
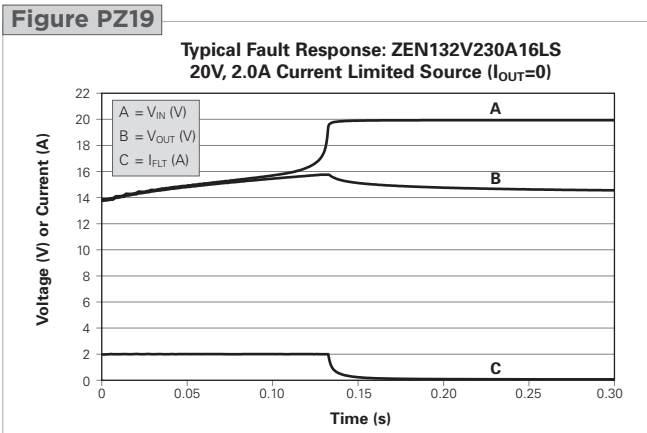
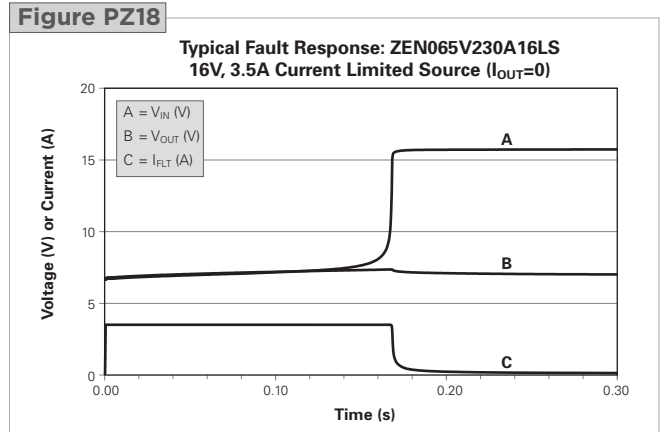
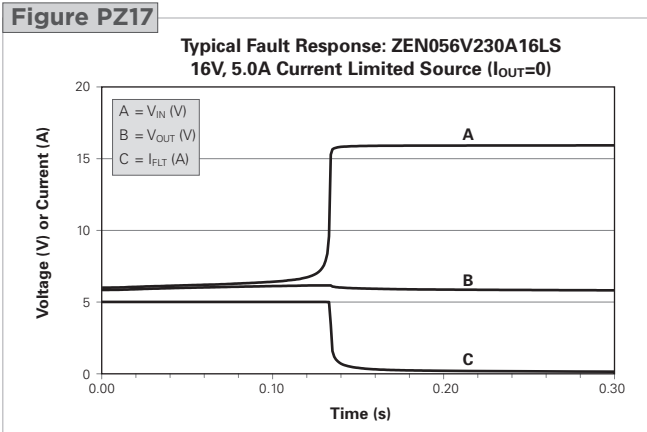
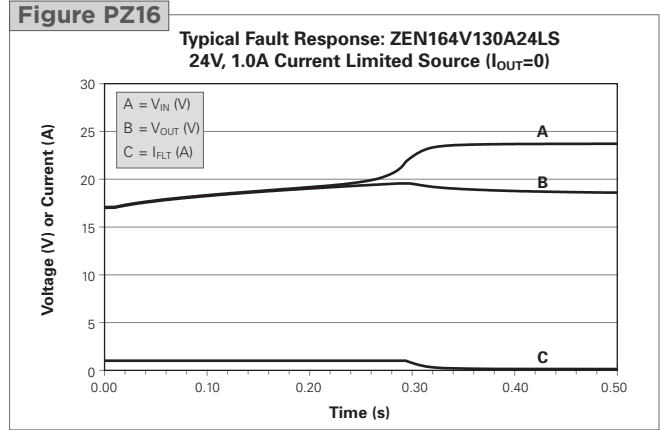
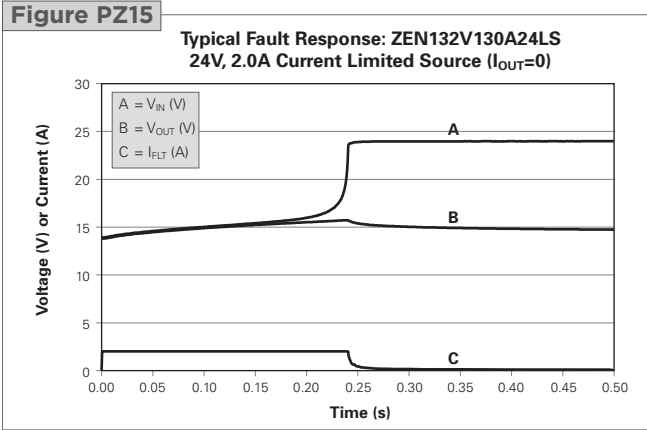

Figure PZ16-PZ22 Basic Operation Examples for PolyZen Devices

Cont'd

4



**Table PZ4 Packaging and Marking Information for PolyZen Devices**

| Part Number       | Bag Quantity | Tape & Reel Quantity | Standard Package |
|-------------------|--------------|----------------------|------------------|
| ZENxxxVyyyAzzLS/M | -            | 3,000                | 15,000           |
| ZENxxxVyyyAzzGS   | -            | 4,000                | 20,000           |

**Table PZ5 Dimensions for PolyZen Devices**

**ZENxxxVyyyAzzLS/M Devices**

|      | A       |         | B       |         | C       |         |
|------|---------|---------|---------|---------|---------|---------|
|      | Min.    | Max.    | Min.    | Max.    | Min.    | Max.    |
| mm   | 3.85    | 4.15    | 3.85    | 4.15    | 1.4     | 2.0     |
| inch | (0.152) | (0.163) | (0.152) | (0.163) | (0.055) | (0.081) |

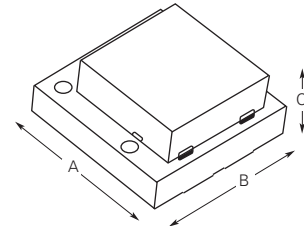

**ZENxxxVyyyAzzGS Devices**

|      | L       |         | W       |         | H       |         |
|------|---------|---------|---------|---------|---------|---------|
|      | Min.    | Max.    | Min.    | Max.    | Min.    | Max.    |
| mm   | 3.85    | 4.15    | 3.85    | 4.15    | 1.16    | 1.25    |
| inch | (0.152) | (0.163) | (0.152) | (0.163) | (0.046) | (0.049) |

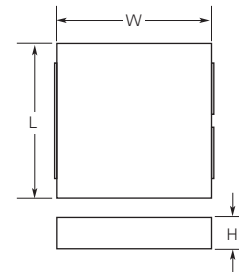

**Table PZ6 Pad Layout and Configuration Information for PolyZen Devices**

| Pin Number | Pin Name         | Pin Function                                      |
|------------|------------------|---|
| 1          | V <sub>IN</sub>  | V <sub>IN</sub> = Protected input to Zener diode  |
| 2          | GND              | GND = Ground                                      |
| 3          | V <sub>OUT</sub> | V <sub>OUT</sub> = Zener regulated voltage output |

**Pin Configuration (Top View)**

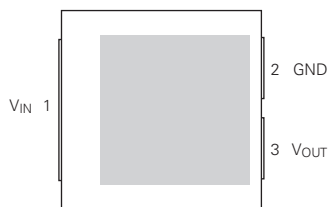

**Pad Dimensions**

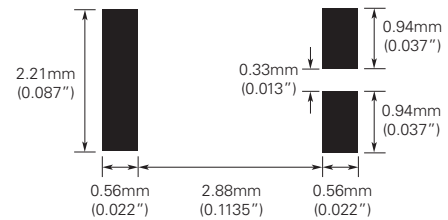

**Solder Reflow and Rework Recommendation for PolyZen Devices**

**Classification Reflow Profiles**

| Profile Feature                                      | Pb-Free Assembly |
|--|------------------|
| <b>Average ramp up rate (Ts<sub>MAX</sub> to Tp)</b> | 3°C/second max.  |
| <b>Preheat</b>                                       |                  |
| • Temperature min. (Ts <sub>MIN</sub> )              | 150°C            |
| • Temperature max. (Ts <sub>MAX</sub> )              | 200°C            |
| • Time (ts <sub>MIN</sub> to ts <sub>MAX</sub> )     | 60-180 seconds   |
| <b>Time maintained above:</b>                        |                  |
| • Temperature (T <sub>L</sub> )                      | 217°C            |
| • Time (t <sub>L</sub> )                             | 60-150 seconds   |
| <b>Peak/Classification temperature (Tp)</b>          | 260°C            |
| <b>Time within 5°C of actual peak temperature</b>    |                  |
| Time (tp)  | 20-40 seconds    |
| <b>Ramp down rate</b>                                | 6°C/second max.  |
| <b>Time 25°C to peak temperature</b>                 | 8 minutes max.   |

**Note:** All temperatures refer to topside of the package, measured on the package body surface.

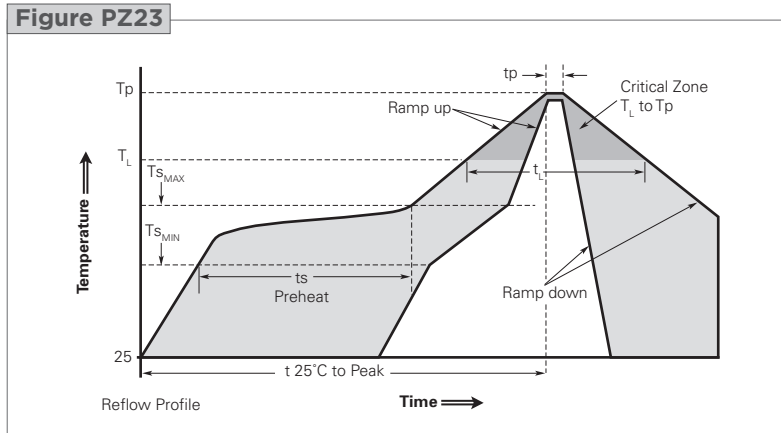

**Tape and Reel Specifications for PolyZen Devices (in Millimeters)**

**Figure PZ24** EIA Referenced Taped Component Dimensions for PolyZen Devices (in Millimeters)

| Description    | ZENxxxVyyyAzzLS/M Devices | ZENxxxVyyyAzzGS Devices |
|----------------|---------------------------|-------------------------|
| A <sub>0</sub> | 4.35                      | 4.35                    |
| B <sub>0</sub> | 4.35                      | 4.35                    |
| K <sub>0</sub> | 2.30                      | 1.80                    |

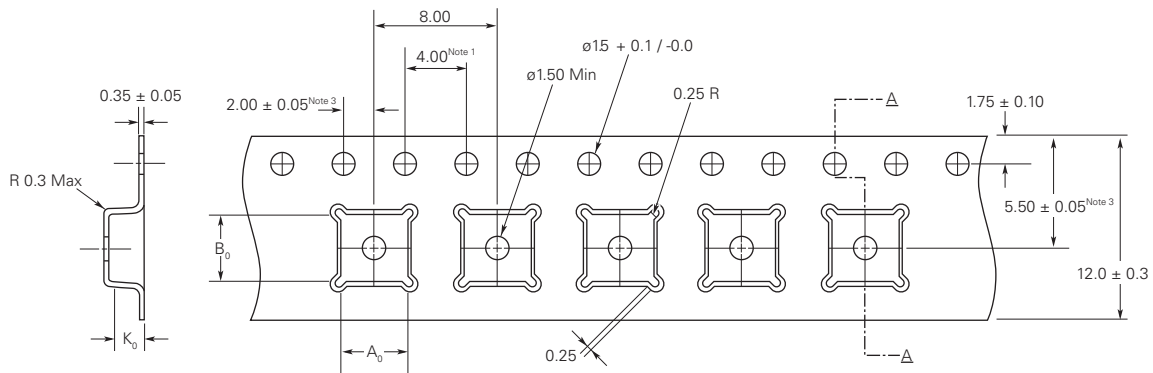

- Notes:**
1. 10 sprocket hole pitch cumulative tolerance ±0.2
  2. Camber in compliance with EIA 481
  3. Pocket position relative to sprocket hole measured as true position of pocket, not pocket hole

**Figure PZ25 Reel Dimensions for PolyZen Devices (in Millimeters)**

| Description      | Dimension (mm) |
|------------------|----------------|
| A <sub>Max</sub> | 330            |
| N <sub>Min</sub> | 102            |
| W <sub>1</sub>   | 8.4            |
| W <sub>2</sub>   | 11.1           |

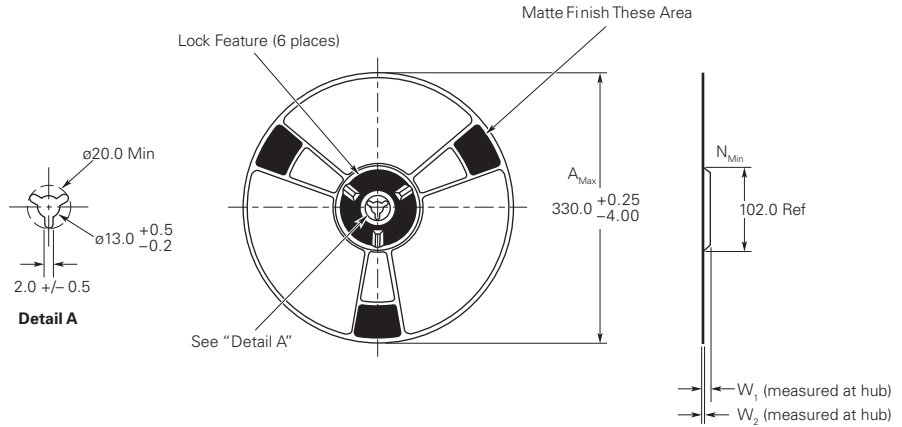

**Part Numbering System for PolyZen Devices**

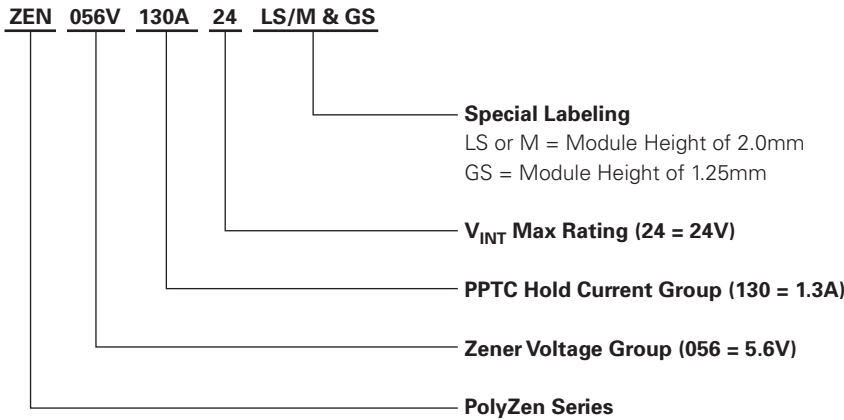

**Part Marking System for PolyZen Devices**

**ZENxxxVyyyAzzLS/M Devices**

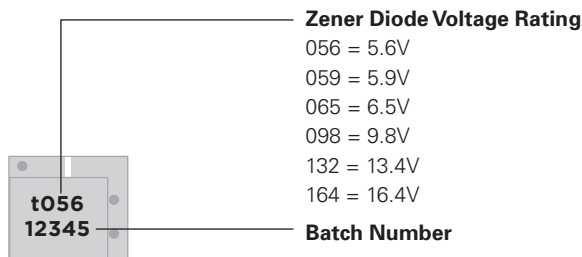

**ZENxxxVyyyAzzGS Devices**

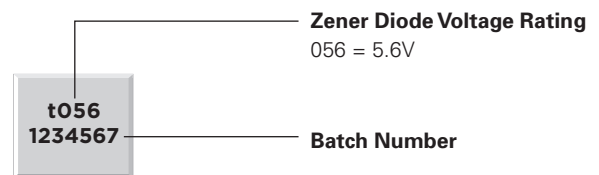

**Warning :**

All information, including illustrations, is believed to be accurate and reliable. Users, however, should independently evaluate the suitability of and test each product selected for their application. Tyco Electronics Corporation makes no warranties as to the accuracy or completeness of the information, and disclaims any liability regarding its use. Tyco Electronics' only obligations are those in the Tyco Electronics' Standard Terms and Conditions of Sale for this product, and in no case will Tyco Electronics be liable for any incidental, indirect, or consequential damages arising from the sale, resale, use, or misuse of the product. Specifications are subject to change without notice. In addition, Tyco Electronics reserves the right to make changes to materials or processing that do not affect compliance with any applicable specification without notification to Buyer.