



Features

- Very High Operating Speed
- Operation down to DC with Square Wave Input
- Low Phase Noise (Typically better than -147dBc/Hz at 10kHz)
- 5V Single Supply Operation
- Low Power Dissipation: 480mW (Typ)
- Surface Mount Plastic Package With Exposed Pad (See Application Notes)

Applications

- DC to 10 GHz PLL applications
- HyperLan
- LMDS
- Instrumentation
- Satellite Communications
- Fibre Optic Communications; OC48, OC192
- Ultra Low Jitter Clock Systems

Ordering Information

ZL40810/DCE (tubes) 8 lead e-pad SOIC
 ZL40810/DCF (tape and reel) 8 lead e-pad SOIC
-40° to +85°C

Description

The ZL40810 is one of a range of 5V supply, very high speed low power prescalers for professional applications with a fixed modulus of divide by 8. The dividing elements are static D type flip flops and therefore allow operation down to DC if the drive signal is a pulse waveform with fast rise times. The output stage has internal 50 ohm pull up giving a 1V p-p output. See application notes for more details.

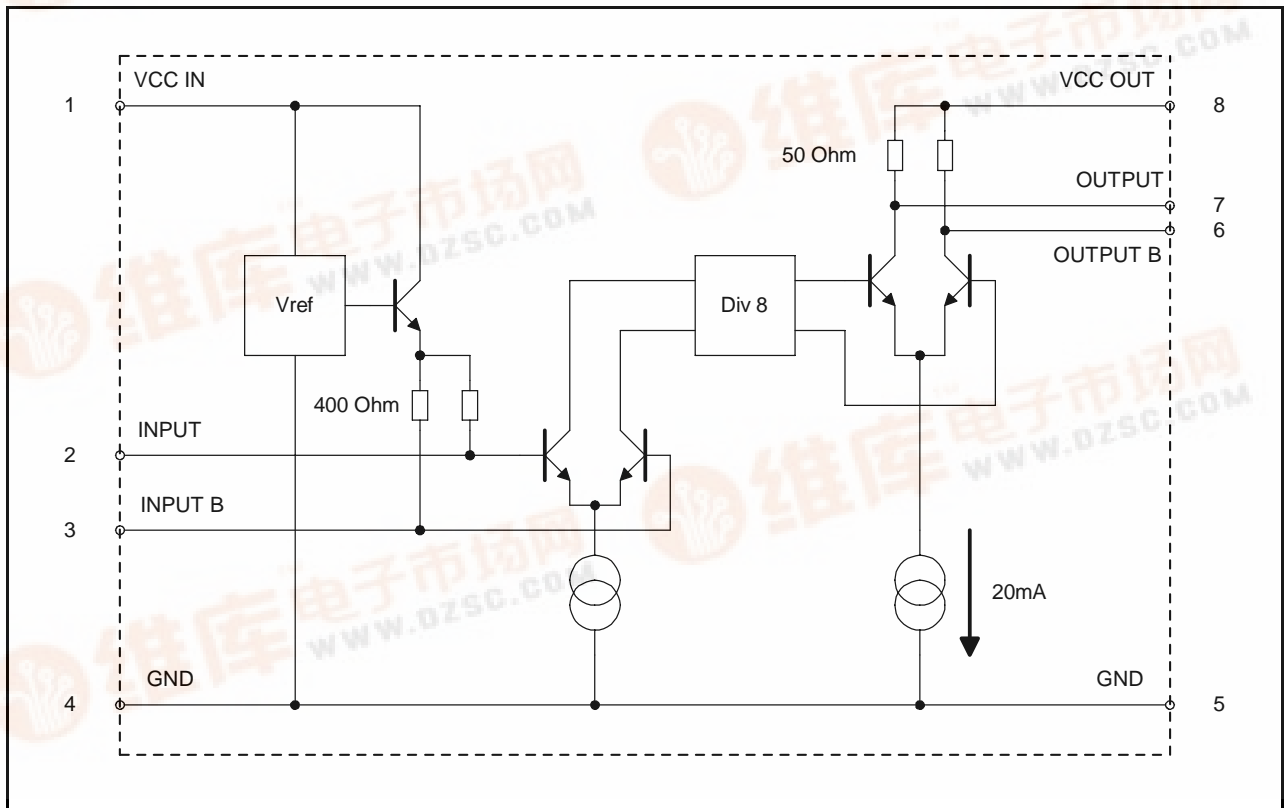
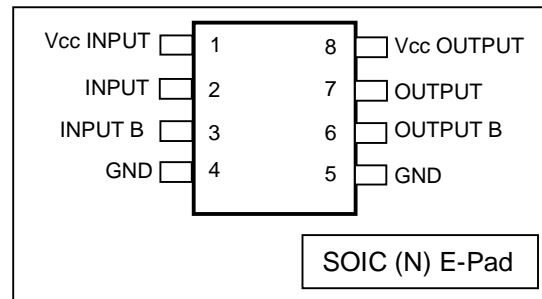

Figure 1 - Block Diagram



Pin Connections - Top View



Application Configuration

Figure 2 shows a recommended application configuration. This example shows the devices set up for single ended operation.

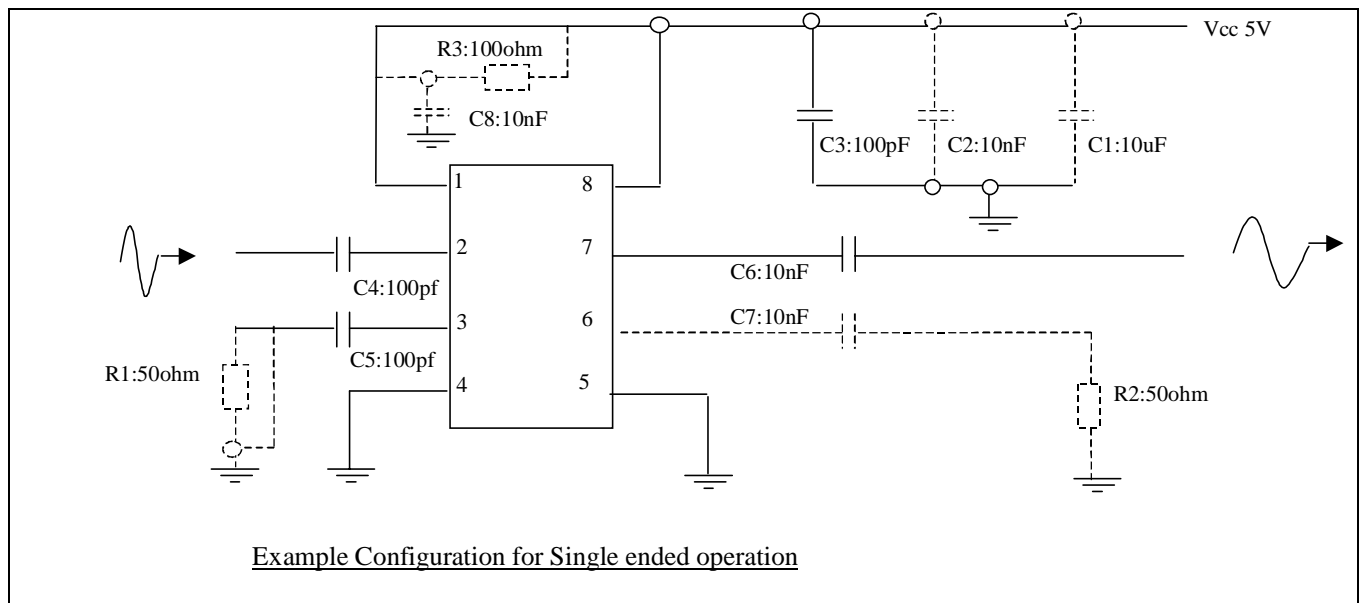

Figure 2 - Recommended circuit configuration

The above circuit diagram shows some components in dotted lines. These are optional in many applications.

1. C1 (10 μ F) and C2 (10 nF) power supply decoupling capacitors may be available on the board already.
2. R3 (100 Ohm) and C8 (10 nF) can be included if further power supply decoupling is required for the first stage biasing circuit. This may optimise the noise and jitter performance. The values are suggestions and may have to be modified if the existing supplies are particularly noisy.
3. R1 (50 Ohm), in series with C5 (100 pF), may reduce feedthrough of the input signal to the output.
4. R2 (50 Ohm) and C7 (10 nF) will help to balance the current drawn from the power supply and may reduce voltage transients on the power supply line.

Evaluation Boards From Zarlink Semiconductor

Zarlink Semiconductor provides prescaler evaluation boards. These are primarily for those interested in performing their own assessment of the operation of the prescalers. The boards are supplied unpopulated and may be assembled for single ended or differential input and output operation, type No. ZLE40008. Fully populated evaluation boards are also available, type No. ZLE40810. Once assembled, all that is required is an RF source and a DC supply for operation. The inputs and outputs are connected via side launch SMA connectors.

Absolute Maximum Ratings

Electrical Characteristics ($T_{amb} = 25^{\circ}\text{C}$, $V_{cc} = 5\text{V}$)

	Parameter	Symbol	Min	Max	Units
1	Supply voltage	V_{cc}		6.5	V
2	Prescaler Input Voltage		2.5		Vp-p
3	ESD protection (Static Discharge)		2k		V
4	Storage temperature	T_{ST}	-65	+150	$^{\circ}\text{C}$
5	Maximum Junction Temp	T_{Jmax}		+125	$^{\circ}\text{C}$
6	Thermal characteristics	TH_{ja}	58.6		$^{\circ}\text{C/W}$ multi-layer PCB

AC/DC Electrical Characteristics

Electrical Characteristics ($T_{amb} = 25^{\circ}\text{C}$, $V_{cc} = 5\text{V}$)[†]

Characteristic	Pin	Min.	Typ.	Max.	Units	Conditions
Supply current	1		0.35		mA	Input stage bias current
Supply current	8		96	136	mA	Divider and output stages
Input frequency	2,3	2		11	GHz	RMS sinewave ¹
Input sensitivity	2,3		-8		dBm	$f_{in} = 1\text{GHz to } 2\text{GHz}$
Input sensitivity	2,3		-15	-10	dBm	$f_{in} = 2\text{GHz to } 9.5\text{GHz}$
Input sensitivity	2,3		-10	0	dBm	$f_{in} = 11\text{GHz}$
Input overload	2,3		8		dBm	$f_{in} = 1\text{GHz to } 4\text{GHz}$
Input overload	2,3		11		dBm	$f_{in} = 5\text{GHz to } 11\text{GHz}$
Input Edge Speed	2,3	900			V/ μs	For <2GHz operation.
Output voltage	6,7		1		Vp-p	Differential Into 50ohm pullup resistors
Output power	6,7	-3	-1	1.2	dBm	Single-ended output, $f_{in} = 2\text{GHz to } 10\text{GHz}$, $pwr_{ip} = -10\text{dBm}$
Phase Noise (10kHz offset)	6,7		-147		dBc/Hz	$F_{in} = 5\text{GHz}$, $pwr_{ip} = 0\text{dBm}$ See Figure 5 to Figure 8.
O/P Duty Cycle	6,7	45	50	55	%	

1. The device characterisation test method incremented the amplitude over the entire range of frequency and ensures that there are no "holes" in the characteristic.

† The characteristics are guaranteed by either production test or design.

† Input sensitivity and output power values assume 50 Ohm source and load impedances

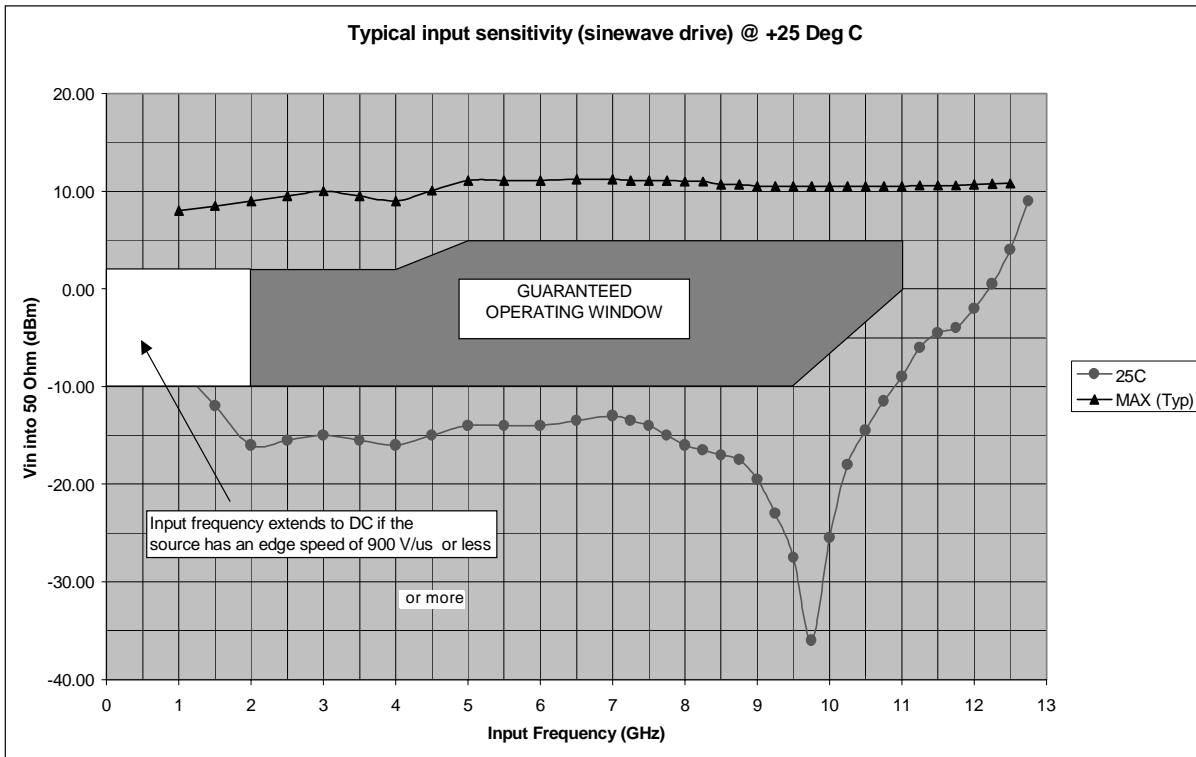

Figure 3 - Input Sensitivity @ +25 Deg C

Electrical Characteristics ($V_{cc} = 5V \pm 5\%$, $T_{amb} = -40$ to $+85C$)†

Characteristic	Pin	Min.	Typ.	Max.	Units	Conditions
Supply current	1		0.35		mA	Input stage bias current ¹
Supply current	8	67	96	125	mA	-40 deg C 5.25V
Supply current	8	54	78	101	mA	-40 deg C 4.75V
Supply current	8	74	105	136	mA	+25 deg C 5.25V
Supply current	8	60	86	111	mA	+25 deg C 4.75V
Supply current	8	80	115	149	mA	+85 deg C 5.25V
Supply current	8	62	91	119	mA	+85 deg C 4.75V

1. Pin 1 is the Vcc pin for the 1st stage bias current. In some applications e.g. if the power supply is noisy, it may be advantageous to add further supply decoupling to this pin (i.e. an additional R, C filter, see diagram of the recommended circuit configuration, Figure 2).

The characteristics are guaranteed by design and characterisation over the range of operating conditions unless otherwise stated: (Input Frequency range 1 to 10GHz rms Sinewave)

Input and Output Characteristics[†]

Characteristic	Pin	Min.	Typ.	Max.	Units	Conditions
Input sensitivity	2,3		-15	-10	dBm	Tamb = 85C, Fin = 2 to 8 GHz
Input overload	2,3	2	5		dBm	fin = 2 GHz
Input overload	2,3	2	8		dBm	fin = 4 GHz
Input overload	2,3	5	13		dBm	fin = 9 GHz
Input overload	2,3	5	11		dBm	fin = 10 GHz
Input Edge Speed	2,3	900			V/ μ s	For <2GHz operation ¹ .
Output voltage	6,7		1		Vp-p	Differential Into 50ohm pullup resistors
Output power	6,7	-4	-1	2	dBm	Single-ended output, fin = 2GHz to 10GHz, pwr ip= -10dBm
O/P Duty Cycle	6,7	45	50	55	%	
Trise and Tfall	6,7		110		ps	

1. For an input signal frequency of less than 2GHz, the slew rate of the sinewave signal becomes progressively too slow for the divider.

Input sensitivity and output power values assume 50 Ohm source and load impedances

For details of the test set-up, refer to the Application Note for RF Prescalers.

The following graph summarises the Input and Output Characteristics table

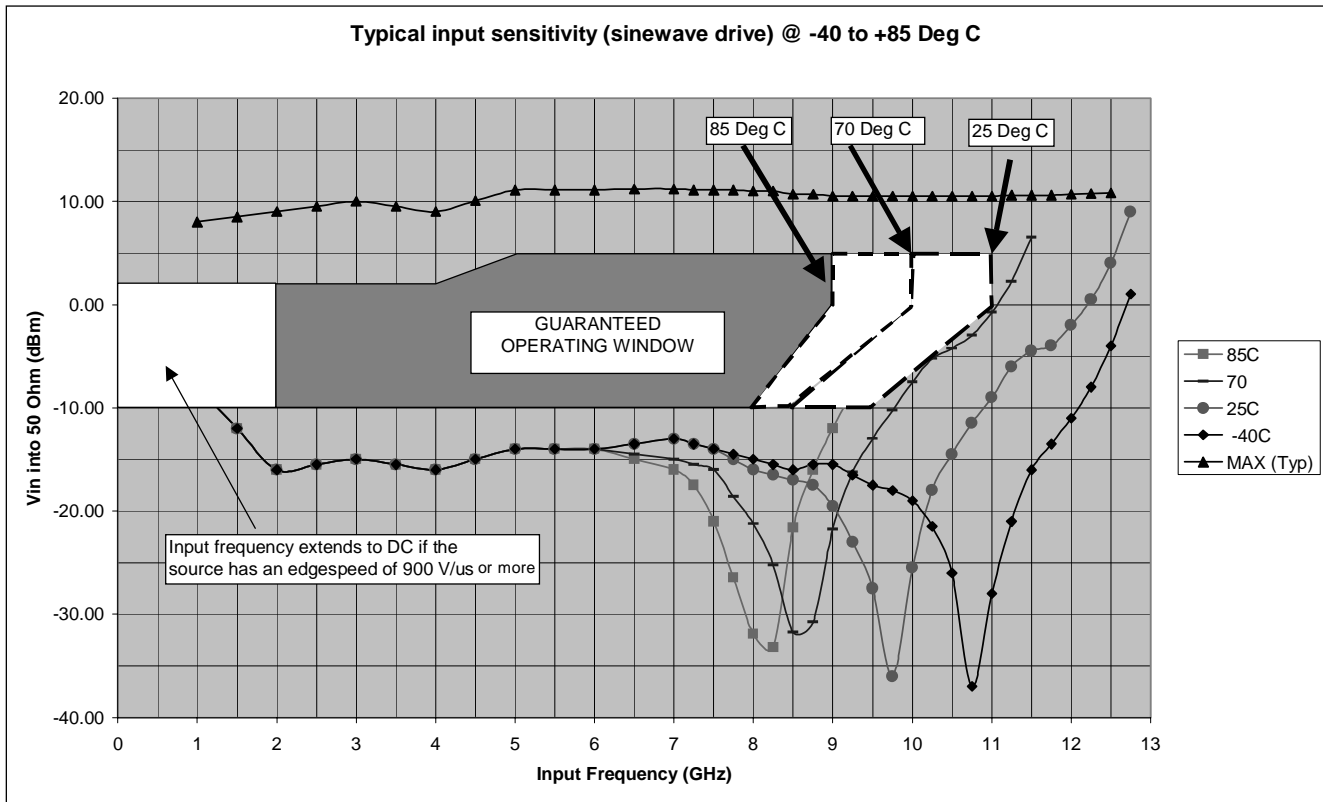

Figure 4 - Input Sensitivity @ -40, +25, +70 and +85 Deg C

Phase Noise Measurement Graphs

The following graph show how the phase noise of the divider output varies with frequency offset from the output (carrier) frequency.

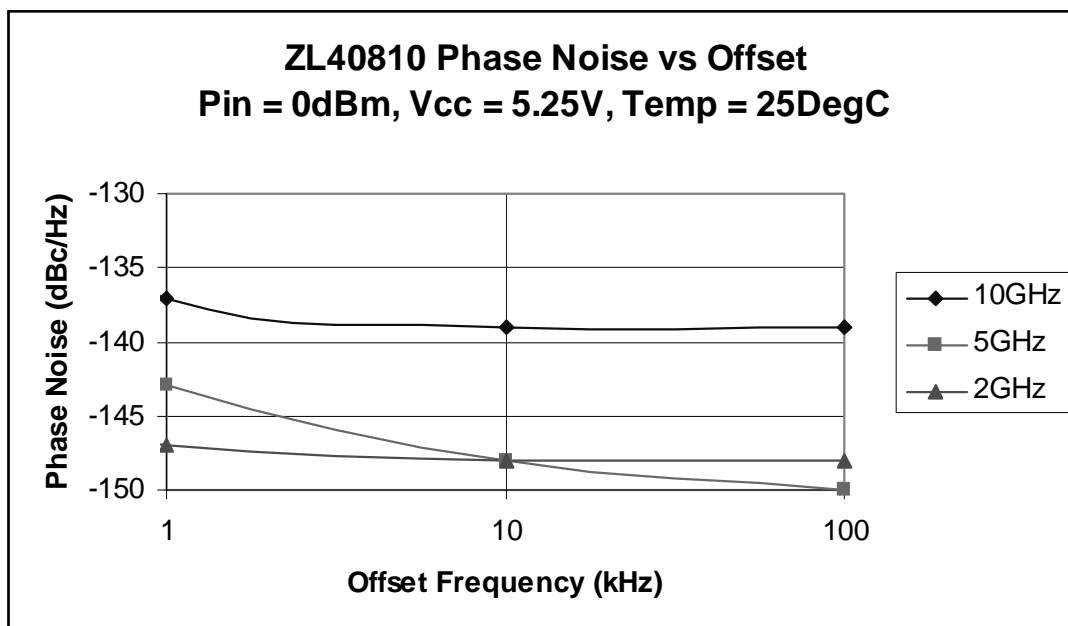

Figure 5 - Figure 8 ZL40810 Phase Noise vs Offset Frequency

The following graph show how the phase noise of the divider output varies with input frequency. The output frequency is the input divided by 8.

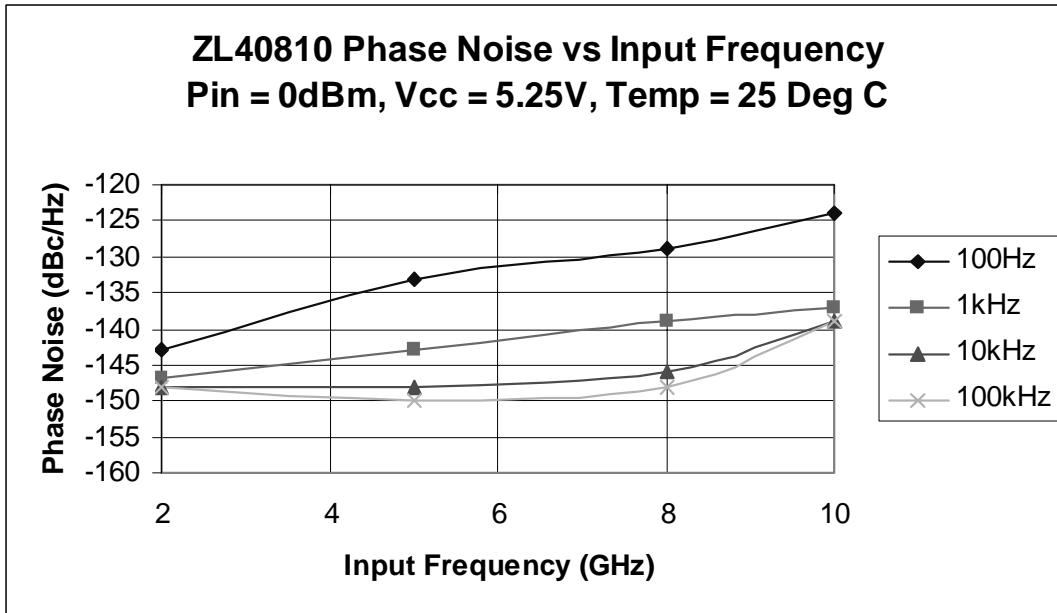

Figure 6 - ZL40810 Phase Noise vs Input Frequency

The following graph show how the phase noise of the divider output varies with input power.

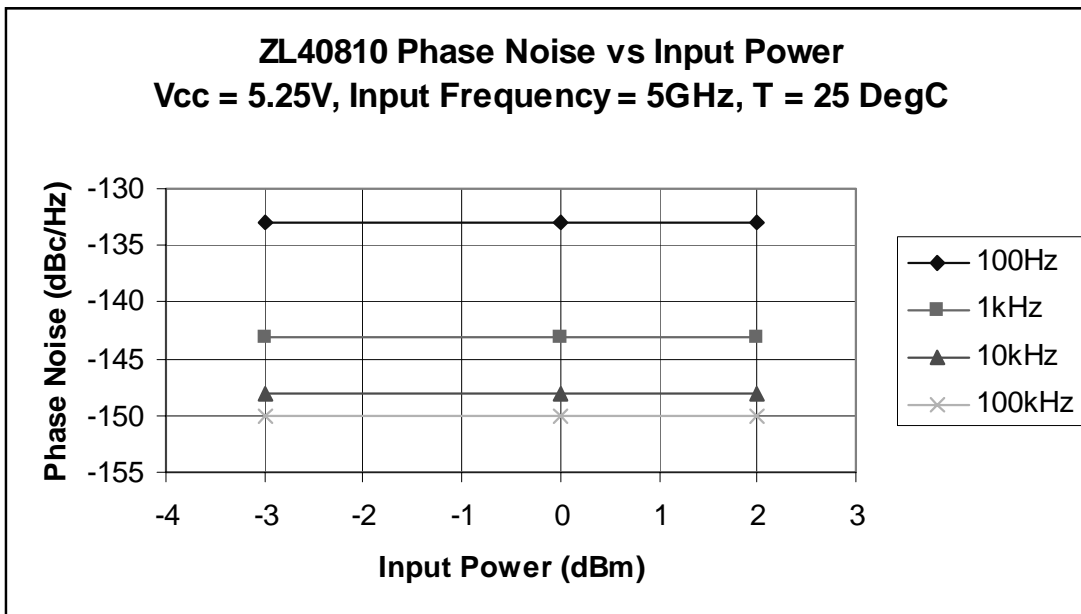

Figure 7 - ZL40810 Phase Noise vs Input Power

The following graph show how the phase noise of the divider output varies with power supply voltage Vcc.

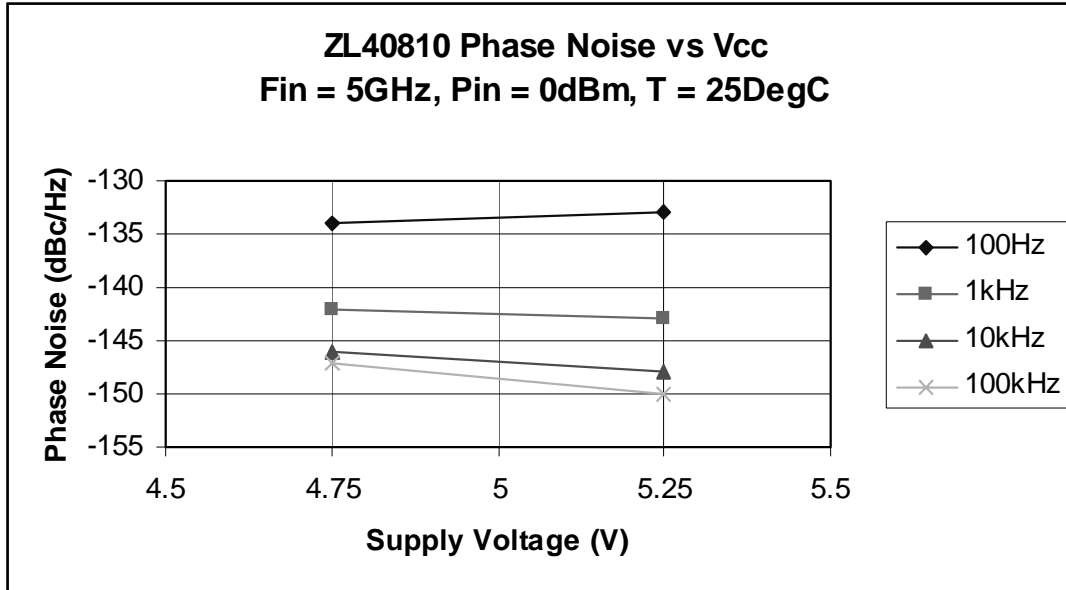

Figure 8 - ZL40810 Phase Noise vs Vcc

Single Ended Output Power

The following graphs show how the output power varies with supply.

Differential output power will be 3dB.

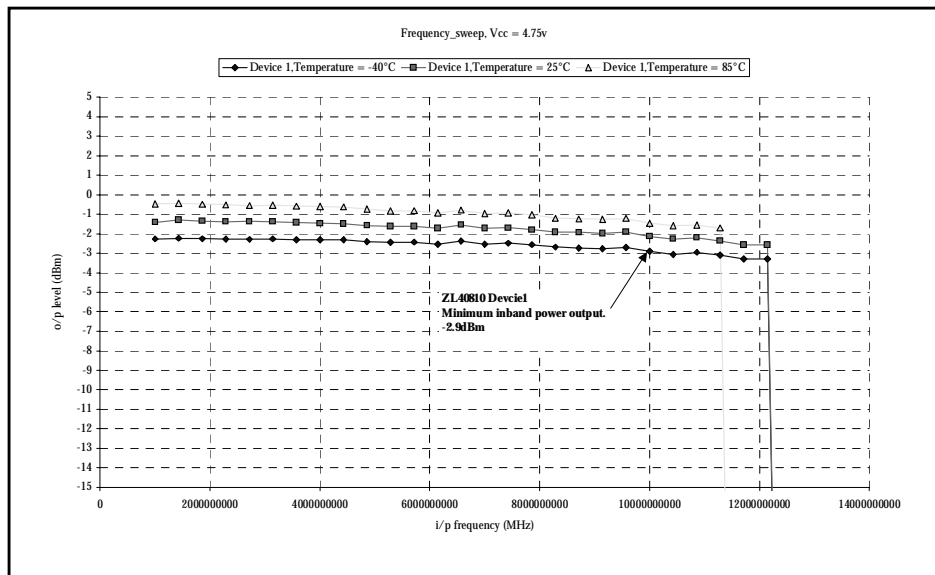

Figure 9 - Pout, Freq, Temp @ Vcc = 4.75

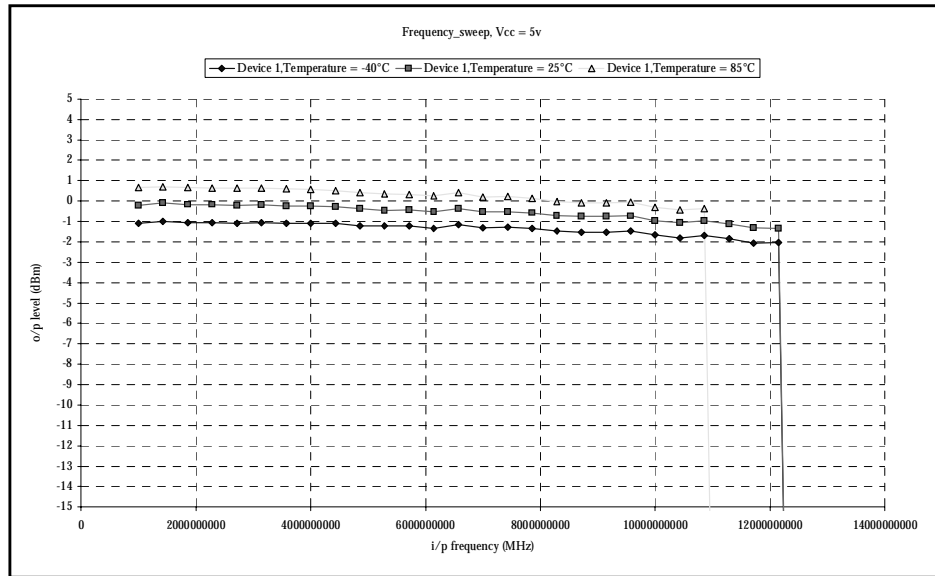

Figure 10 - Pout, Freq, Temp @ Vcc = 5V

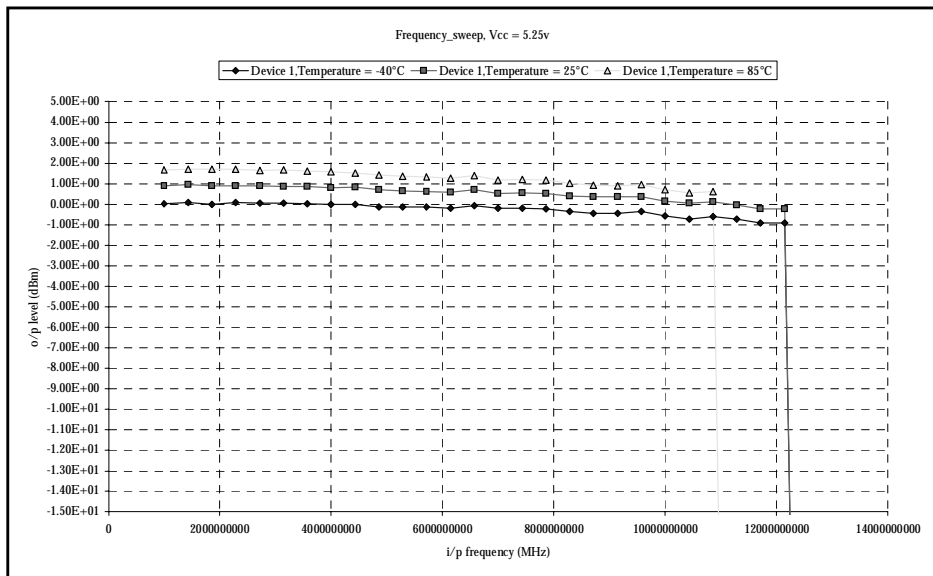

Figure 11 - Pout, Freq, Temp @ Vcc = 5.25V

Oscillographs of the divider output waveforms

The following oscillographs show that the low-level feedthrough of the input waveform can be further reduced by summing the two output pins of the device differentially, refer to Figures 6 and 7.

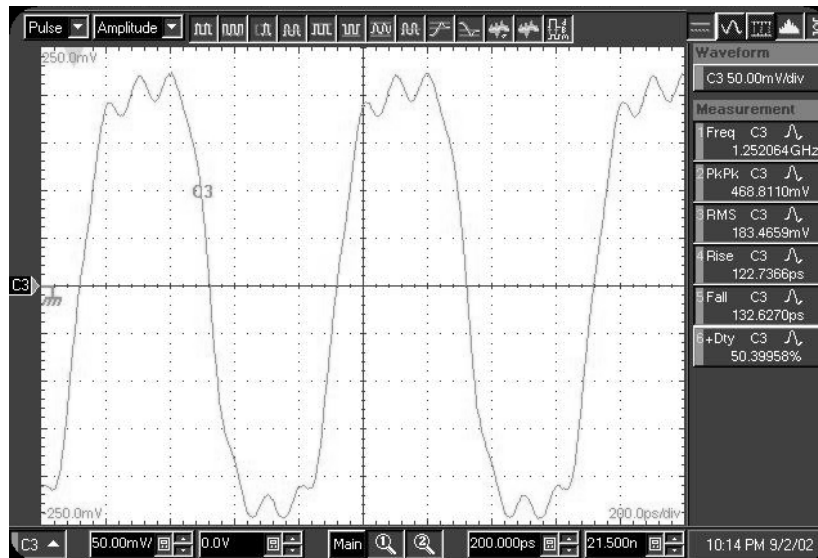

Figure 12 - Feedthrough of the input single-ended output configuration (VCC=5, Vin = 2dBm, Fin = 10GHz)

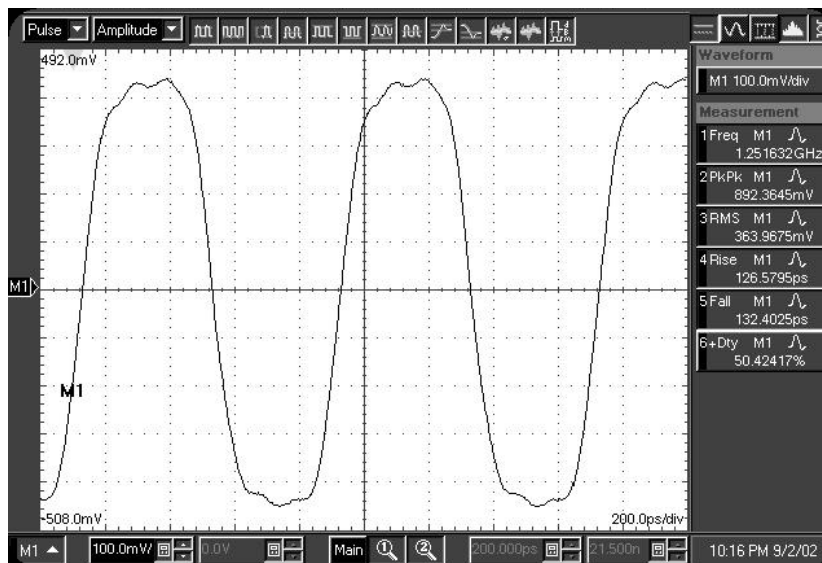

Figure 13 - Feedthrough of the input using differential output configuration (VCC = 5V, Vin = 2dBm, Fin = 10GHz)

Figures 8 and 9 show the output waveforms with a lower input frequency.

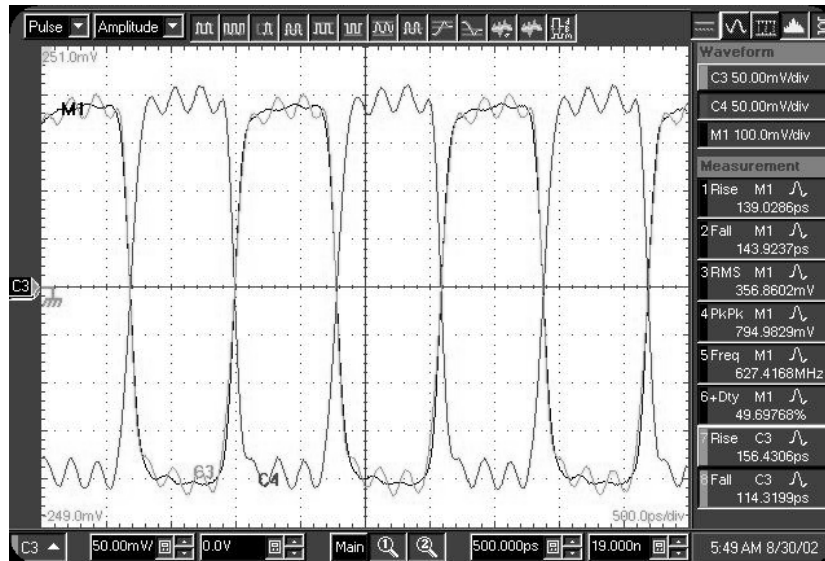

Figure 14 - Differential output with small input amplitude (VCC = 4.75V, Vin = -10dBm, Fin = 5GHz)

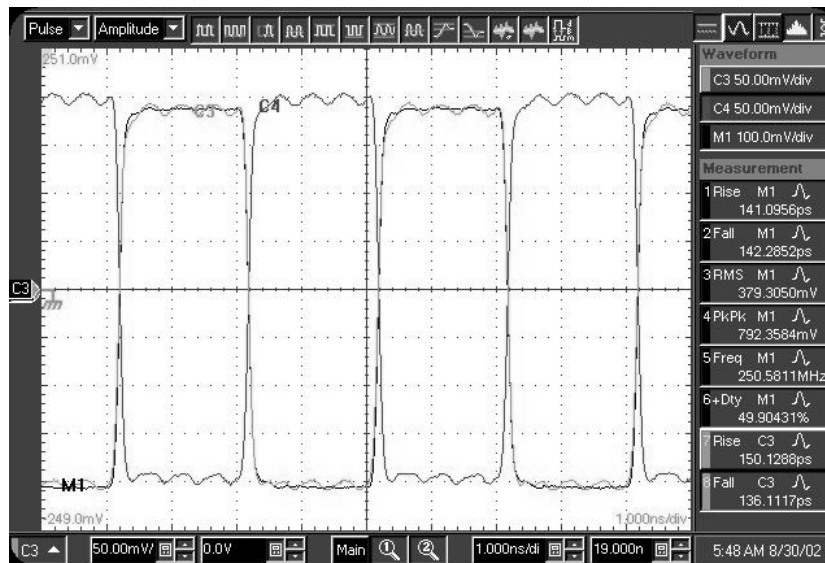
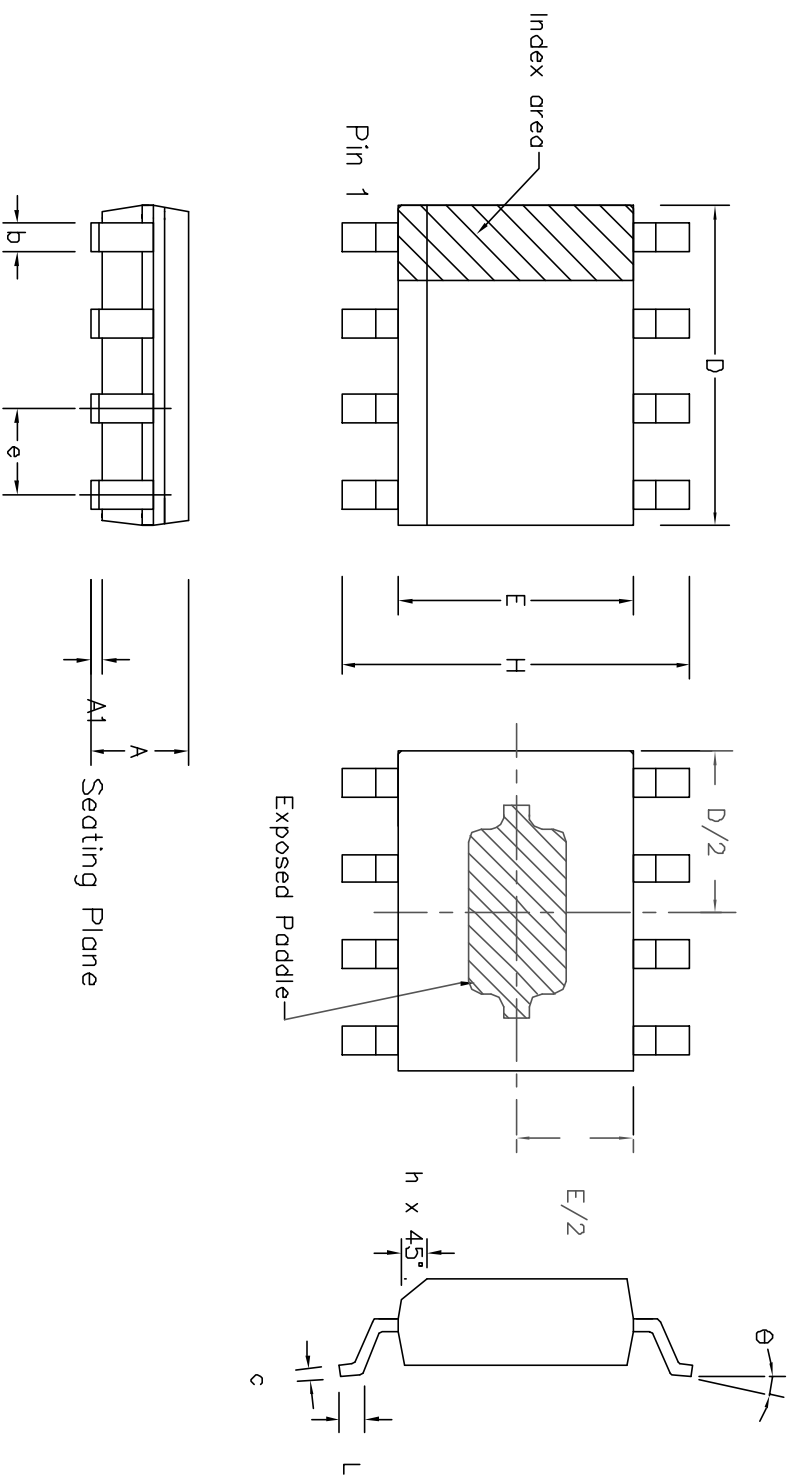

Figure 15 - Differential output with lower input frequency (VCC = 4.75V, Vin = -10dBm, Fin = 2GHz)



	Min	Max	Min	Max
	inches	inches	mm	mm
A	0.056	0.066	1.43	1.68
A1	0.000	0.004	0.00	0.10
D	0.189	0.196	4.80	4.98
H	0.230	0.244	5.84	6.20
E	0.150	0.157	3.81	3.99
L	0.16	0.35	0.41	0.89
e	0.050	BSC	1.27	BSC
b	0.0138	0.0192	0.35	0.49
c	0.0075	0.0098	0.19	0.25
θ	0°	8°	0°	8°
h	0.010	0.016	0.25	0.41
	Pin Features		Pin Features	
N	8		8	

- Notes:
- Controlling dimensions are in inches.
 - Dimensions D & E do not include mould flash, protusion or gate burrs. These shall not exceed 0.006" per side.
 - Exposed paddle not to scale on drawing
 - Extrusion of the exposed pad in bottom side is 0.20 mmTypical
 - Exposed Paddle dimension is 90x90mil Square max, and is governed by the leadframe paddle size.

© Zarlink Semiconductor 2003 All rights reserved.

ISSUE	1	2		
ACN	212933	214385		
DATE	14Jun02	13Jun03		
APPRD.				



Previous package codes
MH / S

Package Code DC

Package Outline for
8 lead e-pad SOIC
(0.150" Body width)

GPDD00790



**For more information about all Zarlink products
visit our Web Site at
www.zarlink.com**

Information relating to products and services furnished herein by Zarlink Semiconductor Inc. or its subsidiaries (collectively "Zarlink") is believed to be reliable. However, Zarlink assumes no liability for errors that may appear in this publication, or for liability otherwise arising from the application or use of any such information, product or service or for any infringement of patents or other intellectual property rights owned by third parties which may result from such application or use. Neither the supply of such information or purchase of product or service conveys any license, either express or implied, under patents or other intellectual property rights owned by Zarlink or licensed from third parties by Zarlink, whatsoever. Purchasers of products are also hereby notified that the use of product in certain ways or in combination with Zarlink, or non-Zarlink furnished goods or services may infringe patents or other intellectual property rights owned by Zarlink.

This publication is issued to provide information only and (unless agreed by Zarlink in writing) may not be used, applied or reproduced for any purpose nor form part of any order or contract nor to be regarded as a representation relating to the products or services concerned. The products, their specifications, services and other information appearing in this publication are subject to change by Zarlink without notice. No warranty or guarantee express or implied is made regarding the capability, performance or suitability of any product or service. Information concerning possible methods of use is provided as a guide only and does not constitute any guarantee that such methods of use will be satisfactory in a specific piece of equipment. It is the user's responsibility to fully determine the performance and suitability of any equipment using such information and to ensure that any publication or data used is up to date and has not been superseded. Manufacturing does not necessarily include testing of all functions or parameters. These products are not suitable for use in any medical products whose failure to perform may result in significant injury or death to the user. All products and materials are sold and services provided subject to Zarlink's conditions of sale which are available on request.

Purchase of Zarlink's I²C components conveys a licence under the Philips I²C Patent rights to use these components in and I²C System, provided that the system conforms to the I²C Standard Specification as defined by Philips.

Zarlink, ZL and the Zarlink Semiconductor logo are trademarks of Zarlink Semiconductor Inc.

Copyright Zarlink Semiconductor Inc. All Rights Reserved.

TECHNICAL DOCUMENTATION - NOT FOR RESALE
