

FEATURES

- Available in the Texas Instruments NanoStar™ and NanoFree™ Packages
- Supports 5-V V_{CC} Operation
- Inputs Accept Voltages to 5.5 V
- Max t_{pd} of 6.3 ns at 3.3 V
- Low Power Consumption, 10- μ A Max I_{CC}
- ± 24 -mA Output Drive at 3.3 V
- I_{off} Supports Partial-Power-Down Mode Operation
- Latch-Up Performance Exceeds 100 mA Per JESD 78, Class II
- ESD Protection Exceeds JESD 22
 - 2000-V Human-Body Model (A114-A)
 - 200-V Machine Model (A115-A)
 - 1000-V Charged-Device Model (C101)

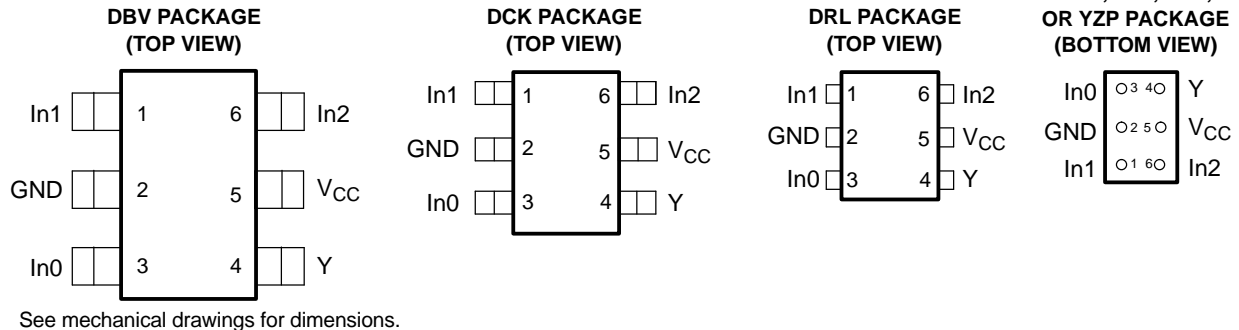

DESCRIPTION/ORDERING INFORMATION

This configurable multiple-function gate is designed for 1.65-V to 5.5-V V_{CC} operation.

The SN74LVC1G58 features configurable multiple functions. The output state is determined by eight patterns of 3-bit input. The user can choose the logic functions AND, OR, NAND, NOR, XOR, inverter, and noninverter. All inputs can be connected to V_{CC} or GND.

This device functions as an independent gate, but because of Schmitt action, it may have different input threshold levels for positive-going (V_{T+}) and negative-going (V_{T-}) signals.

ORDERING INFORMATION

T_A	PACKAGE ⁽¹⁾		ORDERABLE PART NUMBER	TOP-SIDE MARKING ⁽²⁾
-40°C to 85°C	NanoStar™ – WCSP (DSBGA) 0.17-mm Small Bump – YEA	Tape and reel	SN74LVC1G58YEAR	_ _ _ CP _
	NanoFree™ – WCSP (DSBGA) 0.17-mm Small Bump – YZA (Pb-free)		SN74LVC1G58YZAR	
	NanoStar™ – WCSP (DSBGA) 0.23-mm Large Bump – YEP		SN74LVC1G58YEPR	
	NanoFree™ – WCSP (DSBGA) 0.23-mm Large Bump – YZP (Pb-free)		SN74LVC1G58YZPR	
	SOT (SOT-23) – DBV	Tape and reel	SN74LVC1G58DBVR	C58_
	SOT (SC-70) – DCK	Tape and reel	SN74LVC1G58DCKR	CP_
	SOT (SOT-553) – DRL	Reel of 4000	SN74LVC1G58DRLR	CP_

(1) Package drawings, standard packing quantities, thermal data, symbolization, and PCB design guidelines are available at www.ti.com/sc/package.

(2) DBV/DCK/DRL: The actual top-side marking has one additional character that designates the assembly/test site. YEA/YZA, YEP/YZP: The actual top-side marking has three preceding characters to denote year, month, and sequence code, and one following character to designate the assembly/test site. Pin 1 identifier indicates solder-bump composition (1 = SnPb, • = Pb-free).



Please be aware that an important notice concerning availability, standard warranty, and use in critical applications of Texas Instruments semiconductor products and disclaimers thereto appears at the end of this data sheet.

NanoStar, NanoFree are trademarks of Texas Instruments.

SN74LVC1G58 CONFIGURABLE MULTIPLE-FUNCTION GATE

SCES415I–NOVEMBER 2002–REVISED JUNE 2005

DESCRIPTION/ORDERING INFORMATION (CONTINUED)

NanoStar™ and NanoFree™ package technology is a major breakthrough in IC packaging concepts, using the die as the package.

This device is fully specified for partial-power-down applications using I_{off} . The I_{off} circuitry disables the outputs, preventing damaging current backflow through the device when it is powered down.

FUNCTION TABLE

INPUTS			OUTPUT
In2	In1	In0	Y
L	L	L	L
L	L	H	H
L	H	L	L
L	H	H	H
H	L	L	H
H	L	H	H
H	H	L	L
H	H	H	L

LOGIC DIAGRAM (POSITIVE LOGIC)

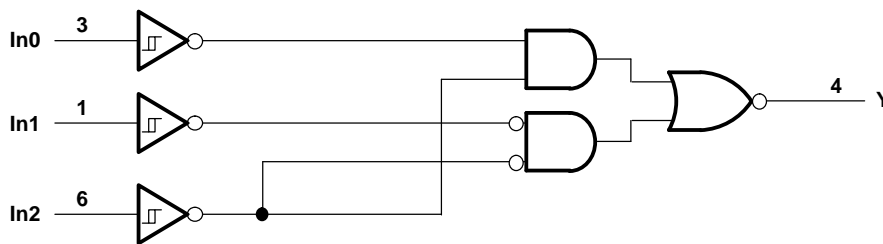

FUNCTION SELECTION TABLE

LOGIC FUNCTION	FIGURE NO.
2-input AND with inverted input	2, 3
2-input NAND	1
2-input NAND with both inputs inverted	4
2-input OR	4
2-input OR with both inputs inverted	1
2-input NOR with inverted input	2, 3
2-input XOR	5

LOGIC CONFIGURATIONS

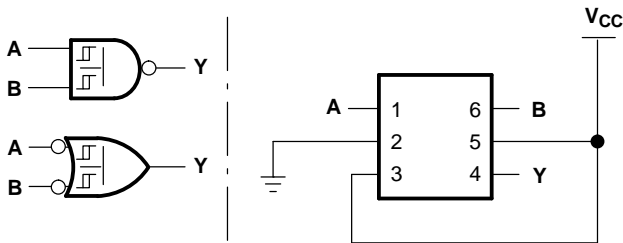

Figure 1. 2-Input NAND Gate

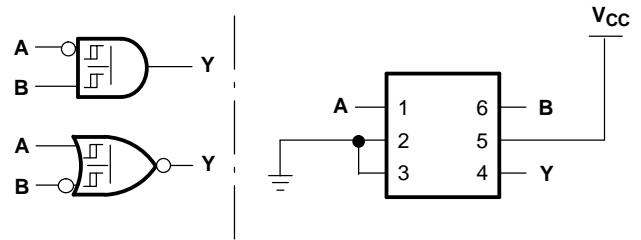

Figure 2. 2-Input AND Gate With Inverted A Input

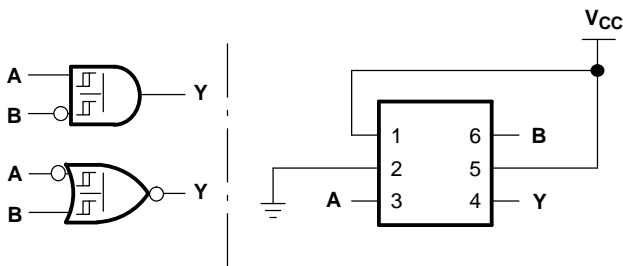

Figure 3. 2-Input AND Gate With Inverted B Input

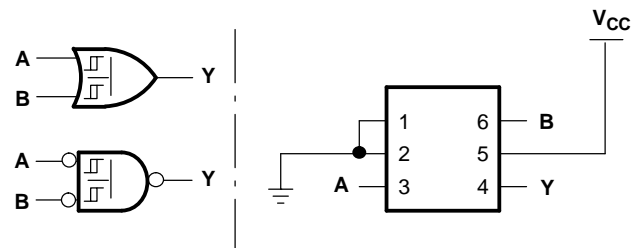

Figure 4. 2-Input OR Gate

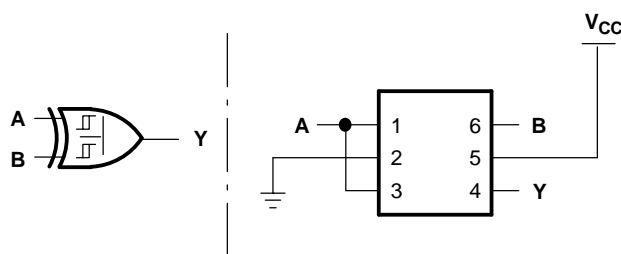

Figure 5. 2-Input XOR Gate

SN74LVC1G58 CONFIGURABLE MULTIPLE-FUNCTION GATE

SCES415I–NOVEMBER 2002–REVISED JUNE 2005



Absolute Maximum Ratings⁽¹⁾

over operating free-air temperature range (unless otherwise noted)

		MIN	MAX	UNIT
V _{CC}	Supply voltage range	−0.5	6.5	V
V _I	Input voltage range ⁽²⁾	−0.5	6.5	V
V _O	Voltage range applied to any output in the high-impedance or power-off state ⁽²⁾	−0.5	6.5	V
V _O	Voltage range applied to any output in the high or low state ⁽²⁾⁽³⁾	−0.5	V _{CC} + 0.5	V
I _{IK}	Input clamp current	V _I < 0		−50 mA
I _{OK}	Output clamp current	V _O < 0		−50 mA
I _O	Continuous output current			±50 mA
	Continuous current through V _{CC} or GND			±100 mA
θ _{JA}	Package thermal impedance ⁽⁴⁾	DBV package		165
		DCK package		259
		DRL package		142
		YEA/YZA package		143
		YEP/YZP package		123
T _{stg}	Storage temperature range	−65	150	°C

- (1) Stresses beyond those listed under "absolute maximum ratings" may cause permanent damage to the device. These are stress ratings only, and functional operation of the device at these or any other conditions beyond those indicated under "recommended operating conditions" is not implied. Exposure to absolute-maximum-rated conditions for extended periods may affect device reliability.
- (2) The input negative-voltage and output voltage ratings may be exceeded if the input and output current ratings are observed.
- (3) The value of V_{CC} is provided in the recommended operating conditions table.
- (4) The package thermal impedance is calculated in accordance with JESD 51-7.

Recommended Operating Conditions⁽¹⁾

		MIN	MAX	UNIT
V _{CC}	Supply voltage	Operating		1.65 5.5
		Data retention only		1.5
V _I	Input voltage	0	5.5	V
V _O	Output voltage	0	V _{CC}	V
I _{OH}	High-level output current	V _{CC} = 1.65 V		−4
		V _{CC} = 2.3 V		−8
		V _{CC} = 3 V		−16
		V _{CC} = 4.5 V		−24
I _{OL}	Low-level output current	V _{CC} = 1.65 V		4
		V _{CC} = 2.3 V		8
		V _{CC} = 3 V		16
		V _{CC} = 4.5 V		24
T _A	Operating free-air temperature	−40	85	°C

- (1) All unused inputs of the device must be held at V_{CC} or GND to ensure proper device operation. Refer to the TI application report, *Implications of Slow or Floating CMOS Inputs*, literature number SCBA004.

Electrical Characteristics

over recommended operating free-air temperature range (unless otherwise noted)

PARAMETER	TEST CONDITIONS	V _{CC}	MIN	TYP ⁽¹⁾	MAX	UNIT
V _{T+} Positive-going input threshold voltage		1.65 V	0.79		1.16	V
		2.3 V	1.11		1.56	
		3 V	1.5		1.87	
		4.5 V	2.16		2.74	
		5.5 V	2.61		3.33	
V _{T-} Negative-going input threshold voltage		1.65 V	0.35		0.62	V
		2.3 V	0.58		0.87	
		3 V	0.84		1.19	
		4.5 V	1.41		1.9	
		5.5 V	1.87		2.29	
ΔV_T Hysteresis (V _{T+} – V _{T-})		1.65 V	0.3		0.62	V
		2.3 V	0.4		0.8	
		3 V	0.53		0.87	
		4.5 V	0.71		1.04	
		5.5 V	0.71		1.11	
V _{OH}	I _{OH} = –100 μ A	1.65 V to 5.5 V	V _{CC} – 0.1			V
	I _{OH} = –4 mA	1.65 V	1.2			
	I _{OH} = –8 mA	2.3 V	1.9			
	I _{OH} = –16 mA	3 V	2.4			
	I _{OH} = –24 mA		2.3			
	I _{OH} = –32 mA	4.5 V	3.8			
V _{OL}	I _{OL} = 100 μ A	1.65 V to 5.5 V			0.1	V
	I _{OL} = 4 mA	1.65 V			0.45	
	I _{OL} = 8 mA	2.3 V			0.3	
	I _{OL} = 16 mA	3 V			0.4	
	I _{OL} = 24 mA				0.55	
	I _{OL} = 32 mA	4.5 V			0.55	
I _I	V _I = 5.5 V or GND	0 to 5.5 V			± 1	μ A
I _{off}	V _I or V _O = 5.5 V	0			± 10	μ A
I _{CC}	V _I = 5.5 V or GND, I _O = 0	1.65 V to 5.5 V			10	μ A
ΔI_{CC}	One input at V _{CC} – 0.6 V, Other inputs at V _{CC} or GND	3 V to 5.5 V			500	μ A
C _i	V _I = V _{CC} or GND	3.3 V	3.5			pF

(1) All typical values are at V_{CC} = 3.3 V, T_A = 25°C.

SN74LVC1G58 CONFIGURABLE MULTIPLE-FUNCTION GATE

SCES415I–NOVEMBER 2002–REVISED JUNE 2005

Switching Characteristics

over recommended operating free-air temperature range (unless otherwise noted) (see [Figure 6](#))

PARAMETER	FROM (INPUT)	TO (OUTPUT)	V _{CC} = 1.8 V ± 0.15 V		V _{CC} = 2.5 V ± 0.2 V		V _{CC} = 3.3 V ± 0.3 V		V _{CC} = 5 V ± 0.5 V		UNIT
			MIN	MAX	MIN	MAX	MIN	MAX	MIN	MAX	
t _{pd}	Any In	Y	3.2	14.4	2	8.3	1.5	6.3	1.1	5.1	ns

Operating Characteristics

T_A = 25°C

PARAMETER	TEST CONDITIONS	V _{CC} = 1.8 V	V _{CC} = 2.5 V	V _{CC} = 3.3 V	V _{CC} = 5 V	UNIT
		TYP	TYP	TYP	TYP	
C _{pd} Power dissipation capacitance	f = 10 MHz	22	22	23	24	pF

PARAMETER MEASUREMENT INFORMATION



TEST	S1
t_{PLH}/t_{PHL}	Open
t_{PLZ}/t_{PZL}	V_{LOAD}
t_{PHZ}/t_{PZH}	GND

V_{CC}	INPUTS		V_M	V_{LOAD}	C_L	R_L	V_{Δ}
	V_I	t_r/t_f					
$1.8\text{ V} \pm 0.15\text{ V}$	V_{CC}	$\leq 2\text{ ns}$	$V_{CC}/2$	$2 \times V_{CC}$	30 pF	1 k Ω	0.15 V
$2.5\text{ V} \pm 0.2\text{ V}$	V_{CC}	$\leq 2\text{ ns}$	$V_{CC}/2$	$2 \times V_{CC}$	30 pF	500 Ω	0.15 V
$3.3\text{ V} \pm 0.3\text{ V}$	3 V	$\leq 2.5\text{ ns}$	1.5 V	6 V	50 pF	500 Ω	0.3 V
$5\text{ V} \pm 0.5\text{ V}$	V_{CC}	$\leq 2.5\text{ ns}$	$V_{CC}/2$	$2 \times V_{CC}$	50 pF	500 Ω	0.3 V

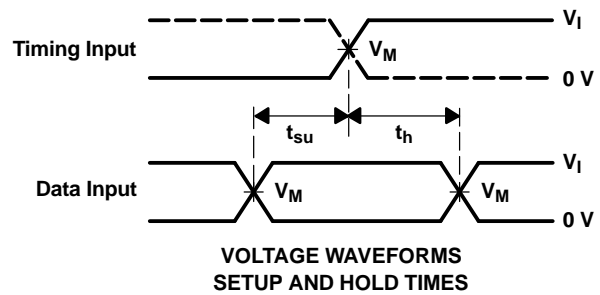
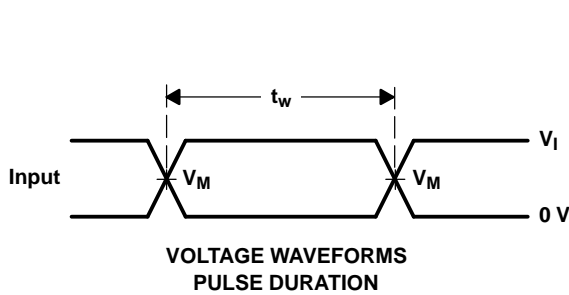

- NOTES:
- A. C_L includes probe and jig capacitance.
 - B. Waveform 1 is for an output with internal conditions such that the output is low, except when disabled by the output control. Waveform 2 is for an output with internal conditions such that the output is high, except when disabled by the output control.
 - C. All input pulses are supplied by generators having the following characteristics: $PRR \leq 10\text{ MHz}$, $Z_O = 50\ \Omega$.
 - D. The outputs are measured one at a time, with one transition per measurement.
 - E. t_{PLZ} and t_{PHZ} are the same as t_{dis} .
 - F. t_{PZL} and t_{PZH} are the same as t_{en} .
 - G. t_{PLH} and t_{PHL} are the same as t_{pd} .
 - H. All parameters and waveforms are not applicable to all devices.

Figure 6. Load Circuit and Voltage Waveforms

PACKAGING INFORMATION

Orderable Device	Status ⁽¹⁾	Package Type	Package Drawing	Pins	Package Qty	Eco Plan ⁽²⁾	Lead/Ball Finish	MSL Peak Temp ⁽³⁾
SN74LVC1G58DBVR	ACTIVE	SOT-23	DBV	6	3000	Green (RoHS & no Sb/Br)	CU NIPDAU	Level-1-260C-UNLIM
SN74LVC1G58DBVRG4	ACTIVE	SOT-23	DBV	6	3000	Green (RoHS & no Sb/Br)	CU NIPDAU	Level-1-260C-UNLIM
SN74LVC1G58DCKR	ACTIVE	SC70	DCK	6	3000	Green (RoHS & no Sb/Br)	CU NIPDAU	Level-1-260C-UNLIM
SN74LVC1G58DCKRG4	ACTIVE	SC70	DCK	6	3000	Green (RoHS & no Sb/Br)	CU NIPDAU	Level-1-260C-UNLIM
SN74LVC1G58DRLR	ACTIVE	SOP	DRL	6	4000	Green (RoHS & no Sb/Br)	CU NIPDAU	Level-1-260C-UNLIM
SN74LVC1G58YEAR	ACTIVE	WCSP	YEA	6	3000	TBD	SNPB	Level-1-260C-UNLIM
SN74LVC1G58YEPR	ACTIVE	WCSP	YEP	6	3000	TBD	SNPB	Level-1-260C-UNLIM
SN74LVC1G58YZAR	ACTIVE	WCSP	YZA	6	3000	Pb-Free (RoHS)	SNAGCU	Level-1-260C-UNLIM
SN74LVC1G58YZPR	ACTIVE	WCSP	YZP	6	3000	Pb-Free (RoHS)	SNAGCU	Level-1-260C-UNLIM

⁽¹⁾ The marketing status values are defined as follows:

ACTIVE: Product device recommended for new designs.

LIFEBUY: TI has announced that the device will be discontinued, and a lifetime-buy period is in effect.

NRND: Not recommended for new designs. Device is in production to support existing customers, but TI does not recommend using this part in a new design.

PREVIEW: Device has been announced but is not in production. Samples may or may not be available.

OBsolete: TI has discontinued the production of the device.

⁽²⁾ Eco Plan - The planned eco-friendly classification: Pb-Free (RoHS) or Green (RoHS & no Sb/Br) - please check <http://www.ti.com/productcontent> for the latest availability information and additional product content details.

TBD: The Pb-Free/Green conversion plan has not been defined.

Pb-Free (RoHS): TI's terms "Lead-Free" or "Pb-Free" mean semiconductor products that are compatible with the current RoHS requirements for all 6 substances, including the requirement that lead not exceed 0.1% by weight in homogeneous materials. Where designed to be soldered at high temperatures, TI Pb-Free products are suitable for use in specified lead-free processes.

Green (RoHS & no Sb/Br): TI defines "Green" to mean Pb-Free (RoHS compatible), and free of Bromine (Br) and Antimony (Sb) based flame retardants (Br or Sb do not exceed 0.1% by weight in homogeneous material)

⁽³⁾ MSL, Peak Temp. -- The Moisture Sensitivity Level rating according to the JEDEC industry standard classifications, and peak solder temperature.

Important Information and Disclaimer:The information provided on this page represents TI's knowledge and belief as of the date that it is provided. TI bases its knowledge and belief on information provided by third parties, and makes no representation or warranty as to the accuracy of such information. Efforts are underway to better integrate information from third parties. TI has taken and continues to take reasonable steps to provide representative and accurate information but may not have conducted destructive testing or chemical analysis on incoming materials and chemicals. TI and TI suppliers consider certain information to be proprietary, and thus CAS numbers and other limited information may not be available for release.

In no event shall TI's liability arising out of such information exceed the total purchase price of the TI part(s) at issue in this document sold by TI to Customer on an annual basis.

DCK (R-PDSO-G6)

PLASTIC SMALL-OUTLINE PACKAGE

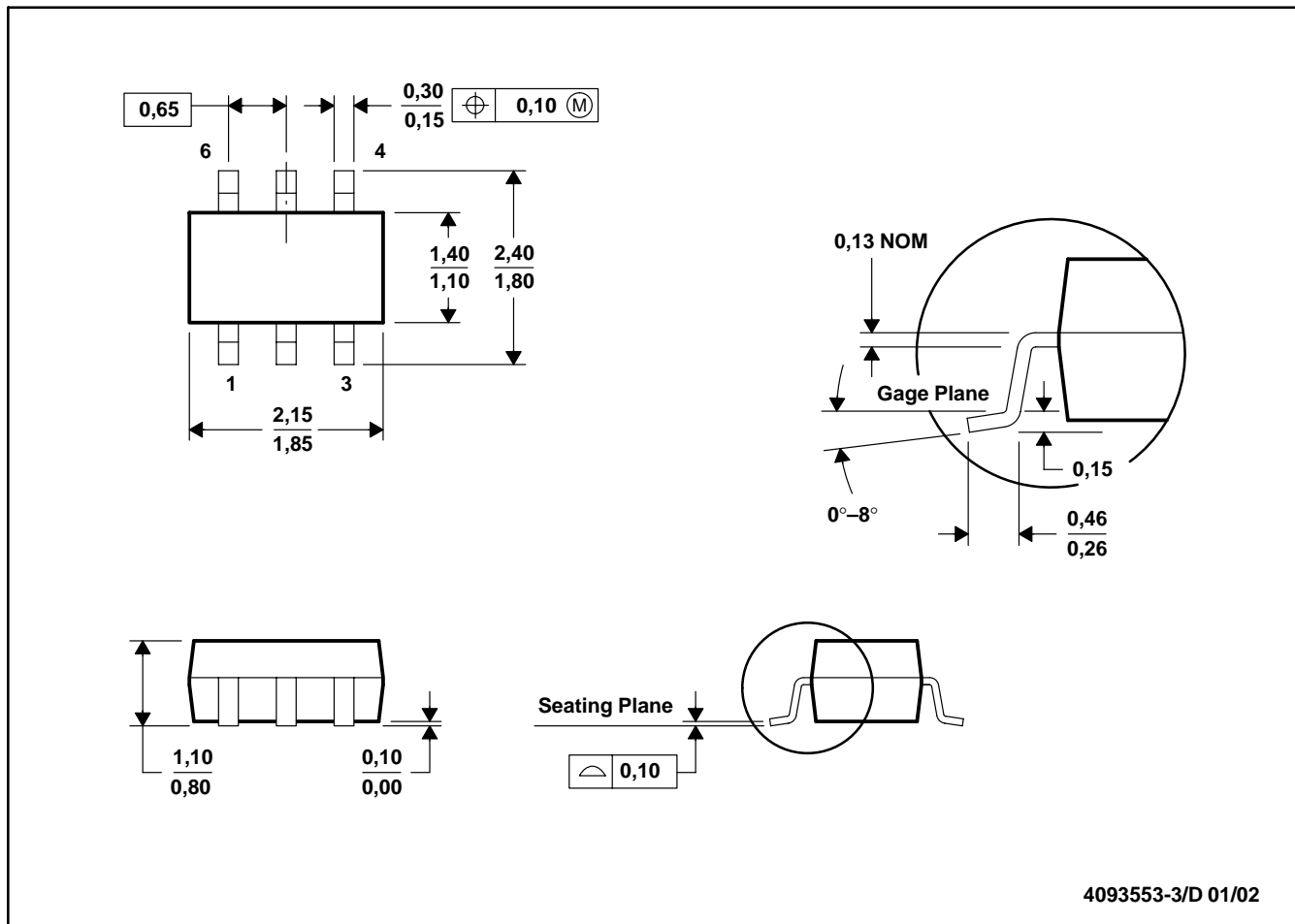

4093553-3/D 01/02

- NOTES: A. All linear dimensions are in millimeters.
 B. This drawing is subject to change without notice.
 C. Body dimensions do not include mold flash or protrusion.
 D. Falls within JEDEC MO-203

DRL (R-PDSO-N6)

PLASTIC SMALL OUTLINE

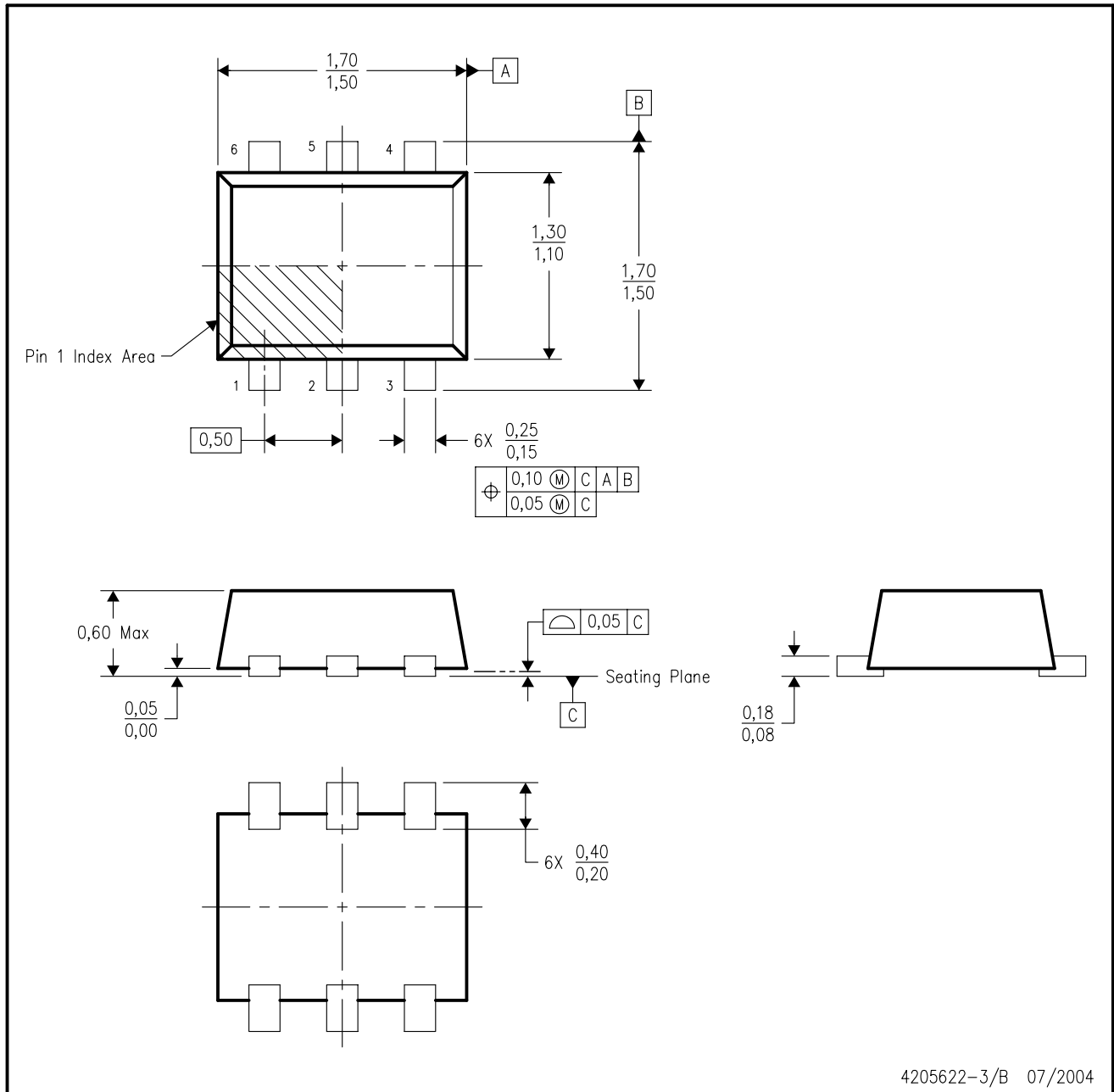

- NOTES:
- A. All linear dimensions are in millimeters.
 - B. This drawing is subject to change without notice.
 - C. JEDEC package registration is pending.

YEA (R-XBGA-N6)

DIE-SIZE BALL GRID ARRAY

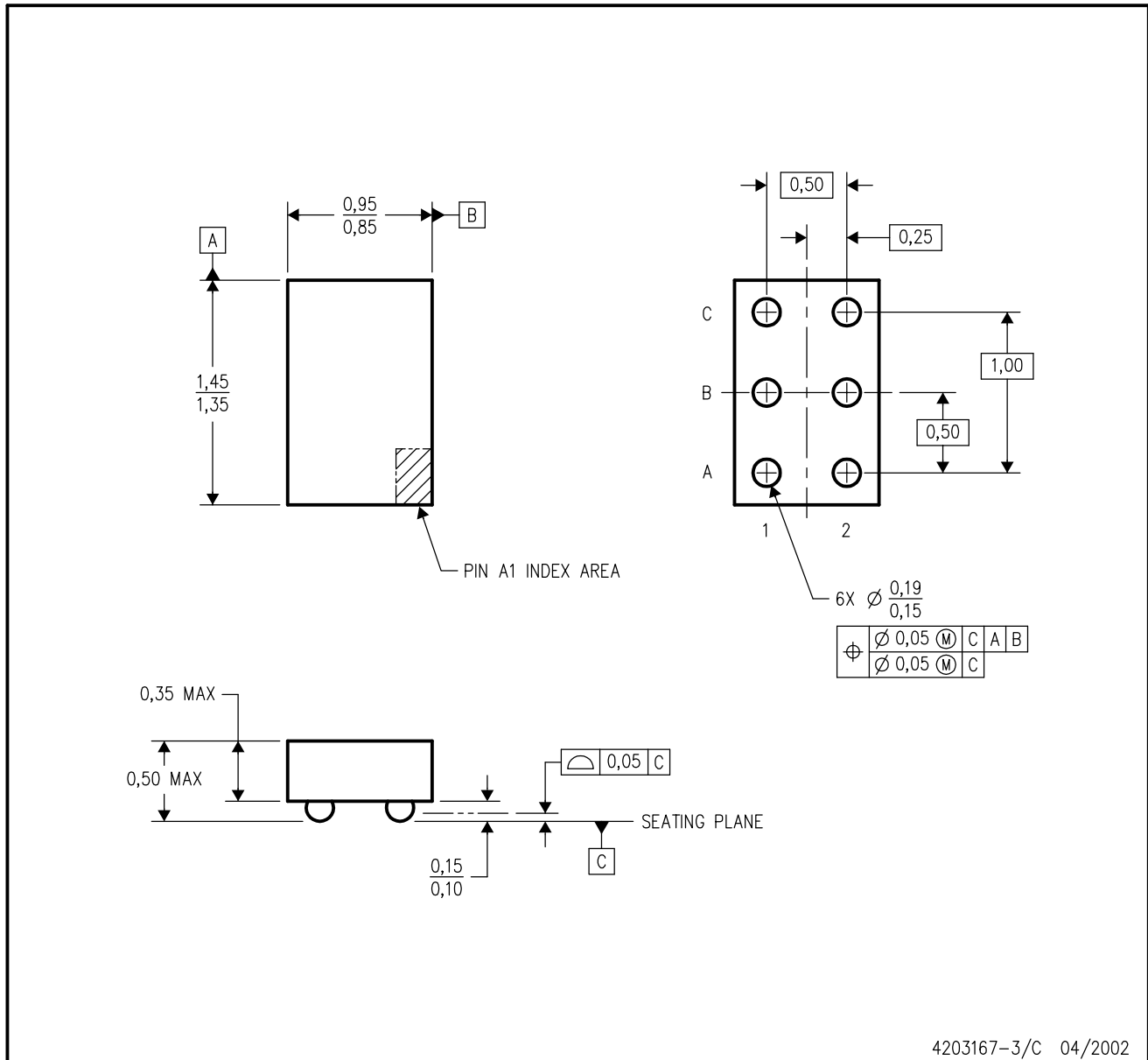

- NOTES:
- A. All linear dimensions are in millimeters.
 - B. This drawing is subject to change without notice.
 - C. NanoStar™ package configuration.
 - D. Package complies to JEDEC MO-211 variation EA.
 - E. This package is tin-lead (SnPb). Refer to the 6 YZA package (drawing 4204151) for lead-free.

NanoStar is a trademark of Texas Instruments.

YZA (R-XBGA-N6)

DIE-SIZE BALL GRID ARRAY

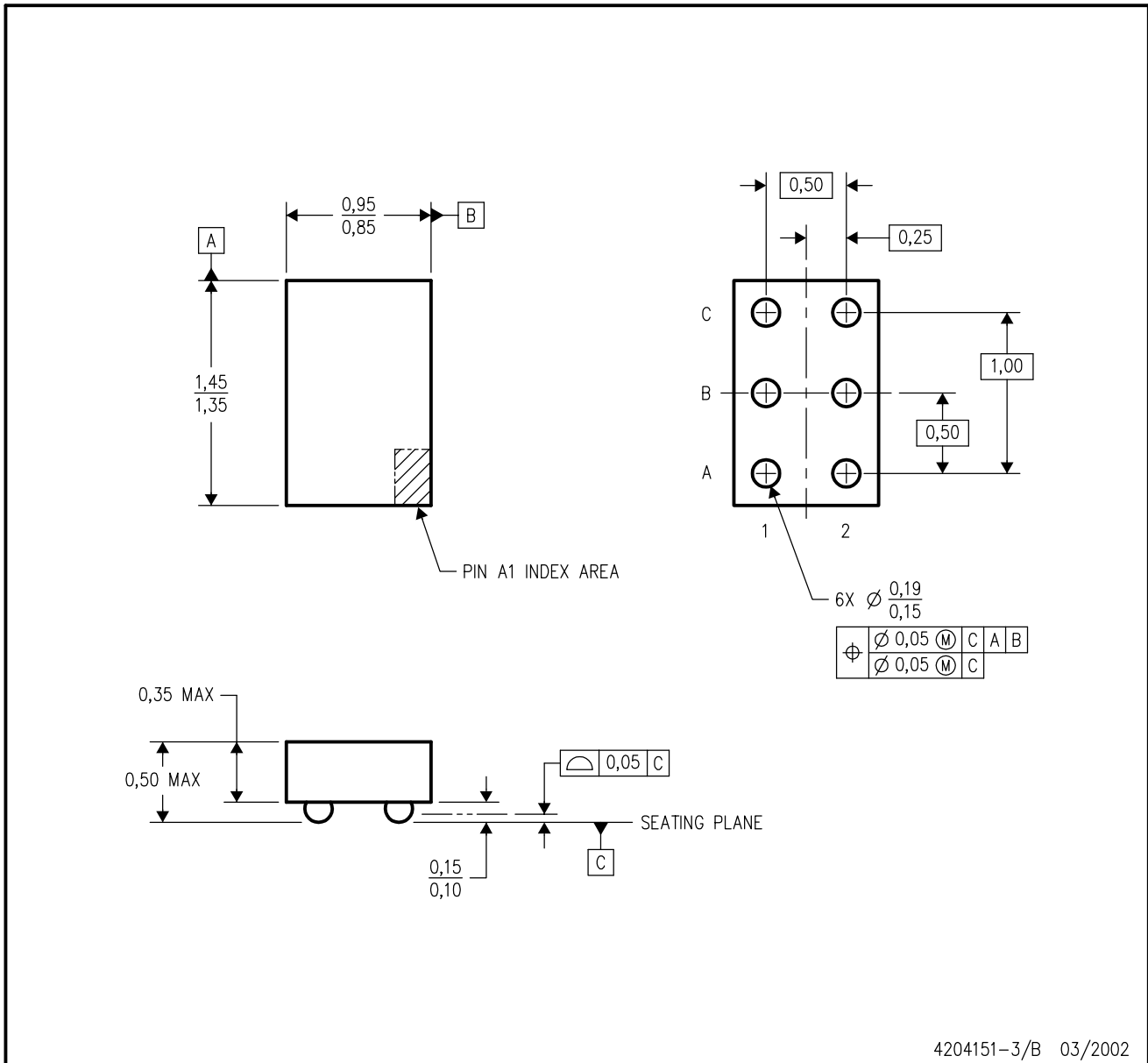

- NOTES:
- A. All linear dimensions are in millimeters.
 - B. This drawing is subject to change without notice.
 - C. NanoFree™ package configuration.
 - D. Package complies to JEDEC MO-211 variation EA.
 - E. This package is lead-free. Refer to the 6 YEA package (drawing 4203167) for tin-lead (SnPb).

NanoFree is a trademark of Texas Instruments.

YZP (R-XBGA-N6)

DIE-SIZE BALL GRID ARRAY

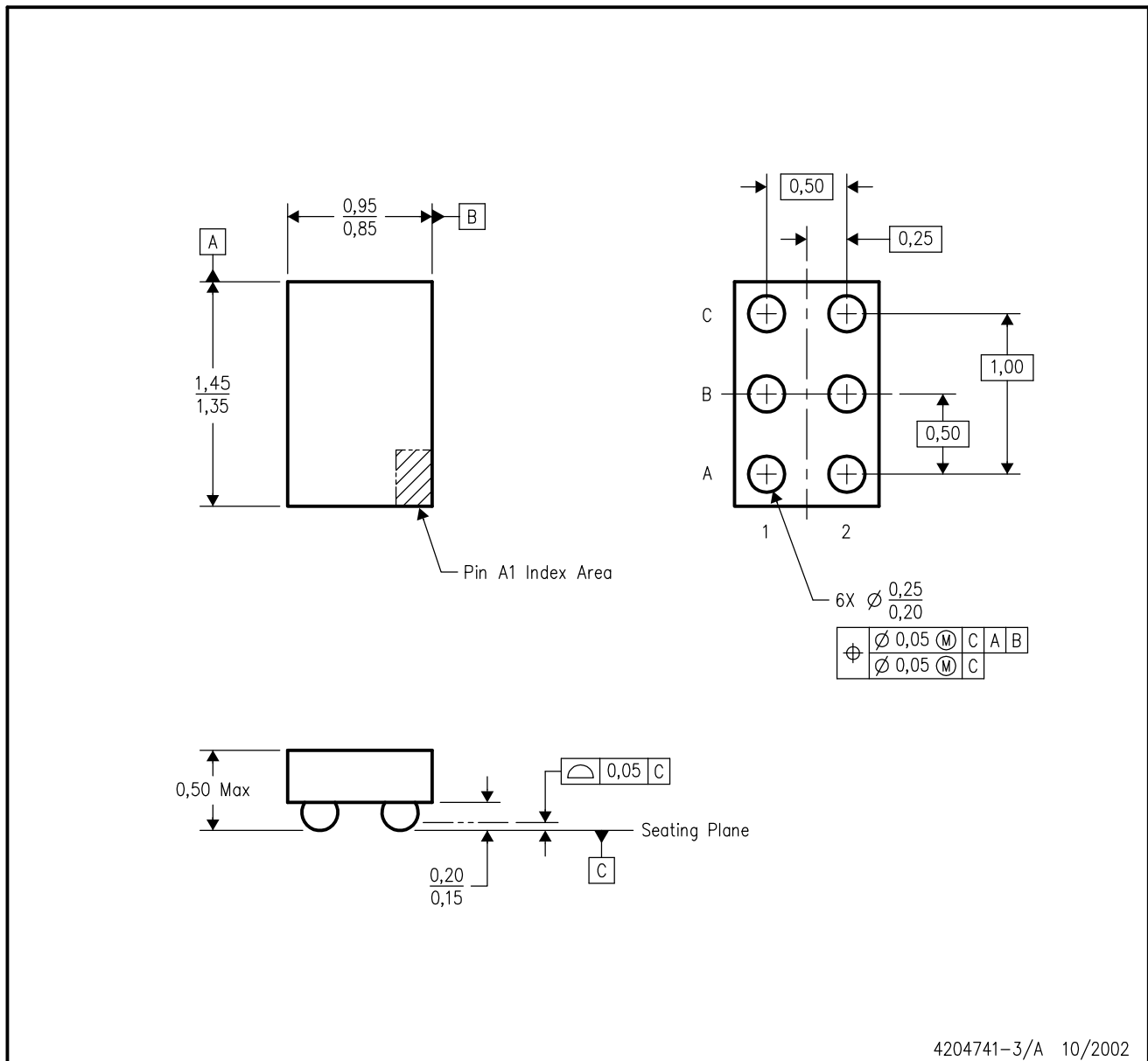

- NOTES:
- A. All linear dimensions are in millimeters.
 - B. This drawing is subject to change without notice.
 - C. NanoFree™ package configuration.
 - D. This package is lead-free. Refer to the 6 YEP package (drawing 4204725) for tin-lead (SnPb).

NanoFree is a trademark of Texas Instruments.

YEP (R-XBGA-N6)

DIE-SIZE BALL GRID ARRAY

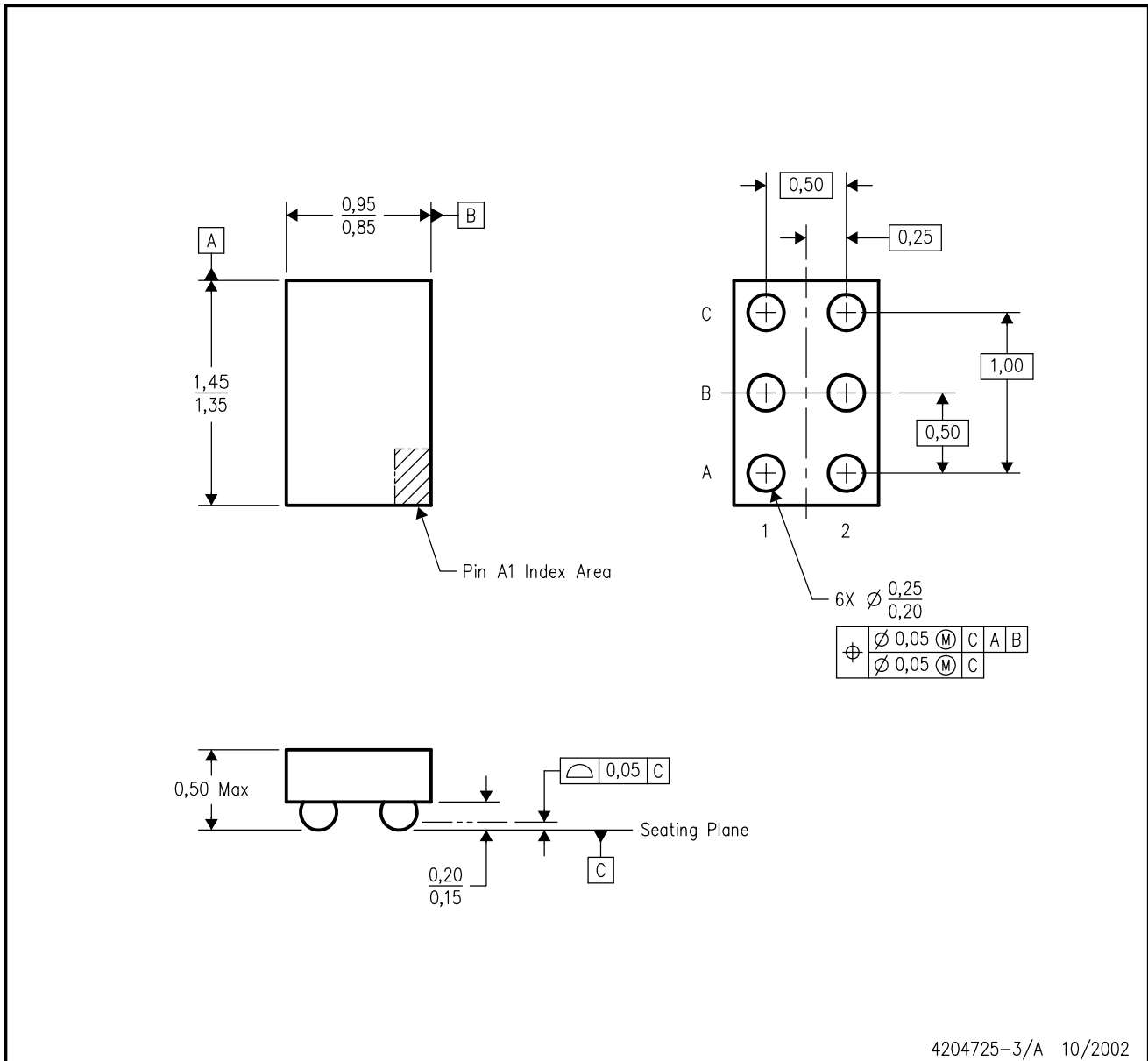

- NOTES:
- A. All linear dimensions are in millimeters.
 - B. This drawing is subject to change without notice.
 - C. NanoStar™ package configuration.
 - D. This package is tin-lead (SnPb). Refer to the 6 YZP package (drawing 4204741) for lead-free.

NanoStar is a trademark of Texas Instruments.

IMPORTANT NOTICE

Texas Instruments Incorporated and its subsidiaries (TI) reserve the right to make corrections, modifications, enhancements, improvements, and other changes to its products and services at any time and to discontinue any product or service without notice. Customers should obtain the latest relevant information before placing orders and should verify that such information is current and complete. All products are sold subject to TI's terms and conditions of sale supplied at the time of order acknowledgment.

TI warrants performance of its hardware products to the specifications applicable at the time of sale in accordance with TI's standard warranty. Testing and other quality control techniques are used to the extent TI deems necessary to support this warranty. Except where mandated by government requirements, testing of all parameters of each product is not necessarily performed.

TI assumes no liability for applications assistance or customer product design. Customers are responsible for their products and applications using TI components. To minimize the risks associated with customer products and applications, customers should provide adequate design and operating safeguards.

TI does not warrant or represent that any license, either express or implied, is granted under any TI patent right, copyright, mask work right, or other TI intellectual property right relating to any combination, machine, or process in which TI products or services are used. Information published by TI regarding third-party products or services does not constitute a license from TI to use such products or services or a warranty or endorsement thereof. Use of such information may require a license from a third party under the patents or other intellectual property of the third party, or a license from TI under the patents or other intellectual property of TI.

Reproduction of information in TI data books or data sheets is permissible only if reproduction is without alteration and is accompanied by all associated warranties, conditions, limitations, and notices. Reproduction of this information with alteration is an unfair and deceptive business practice. TI is not responsible or liable for such altered documentation.

Resale of TI products or services with statements different from or beyond the parameters stated by TI for that product or service voids all express and any implied warranties for the associated TI product or service and is an unfair and deceptive business practice. TI is not responsible or liable for any such statements.

Following are URLs where you can obtain information on other Texas Instruments products and application solutions:

Products		Applications	
Amplifiers	amplifier.ti.com	Audio	www.ti.com/audio
Data Converters	dataconverter.ti.com	Automotive	www.ti.com/automotive
DSP	dsp.ti.com	Broadband	www.ti.com/broadband
Interface	interface.ti.com	Digital Control	www.ti.com/digitalcontrol
Logic	logic.ti.com	Military	www.ti.com/military
Power Mgmt	power.ti.com	Optical Networking	www.ti.com/opticalnetwork
Microcontrollers	microcontroller.ti.com	Security	www.ti.com/security
		Telephony	www.ti.com/telephony
		Video & Imaging	www.ti.com/video
		Wireless	www.ti.com/wireless

Mailing Address: Texas Instruments
Post Office Box 655303 Dallas, Texas 75265

Copyright © Each Manufacturing Company.

All Datasheets cannot be modified without permission.

This datasheet has been download from :

www.AllDataSheet.com

100% Free DataSheet Search Site.

Free Download.

No Register.

Fast Search System.

www.AllDataSheet.com