

[查询ZR431L供应商](#)

[捷多邦, 专业PCB打样工厂](#)

[, 24小时加急出货](#)

**ZR431L**

# ADJUSTABLE PRECISION ZENER SHUNT REGULATOR

Issue 1 - NOVEMBER 1998

## DEVICE DESCRIPTION

The ZR431L is a three terminal adjustable shunt regulator offering excellent temperature stability and output current handling capability up to 25mA. The output voltage may be set to any chosen voltage between 1.24 and 10 volts by selection of two external divider resistors.

The devices can be used as a replacement for zener diodes in many applications requiring an improvement in zener performance.

The ZR431L is particularly used in the feedback control loop of switch mode power supplies. In this application the device 1.24 volt reference enables the generation of low voltage supplies, typically 3.3 volts or 3 volts.

## FEATURES

- Surface mount SOT23 package
- TO92 package
- 2.5% and 1% tolerance
- Maximum temperature coefficient 50 ppm/°C
- Temperature compensated for operation over the full temperature range
- Programmable output voltage
- 100µA to 25mA current sink capability
- Low output noise

## APPLICATIONS

- Shunt regulator
- Series regulator
- Voltage monitor
- Over voltage/ under voltage protection
- Switch mode power supplies

## SCHEMATIC DIAGRAM

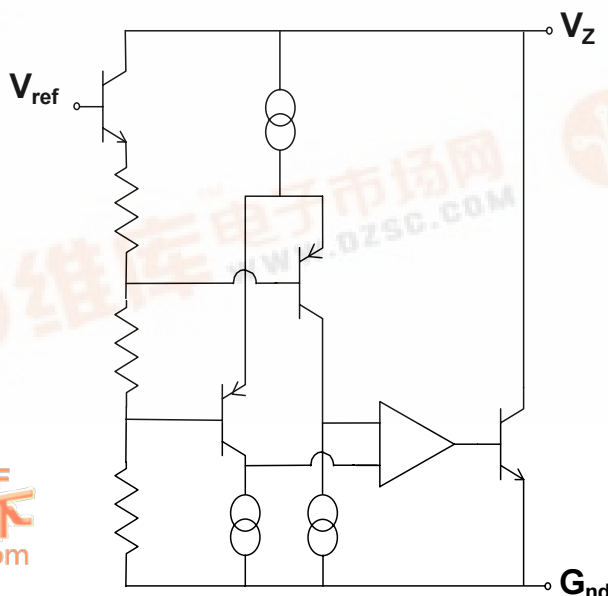

# ZR431L

## ABSOLUTE MAXIMUM RATING

Cathode Voltage (V <sub>Z</sub> )	10V
Cathode Current	50mA
Operating Temperature	-40 to 85°C
Storage Temperature	-55 to 125°C

Power Dissipation (T<sub>amb</sub>=25°C,  
T<sub>jmax</sub>=150°C)

SOT23	330mW
TO92	600mW

## Recommended Operating Conditions

	Min	Max
Cathode Voltage	V <sub>REF</sub>	10V
Cathode Current	100μA	25mA

## ELECTRICAL CHARACTERISTICS TEST CONDITIONS (Unless otherwise stated): T<sub>amb</sub>=25°C

PARAMETER	SYMBOL	VALUE			UNITS	CONDITIONS
		MIN	TYP	MAX		
Reference Voltage 2.5% 1.0%	V <sub>ref</sub>	1.209 1.228	1.24 1.24	1.271 1.252	V	I <sub>L</sub> =10mA (Fig1), V <sub>Z</sub> =V <sub>ref</sub>
Deviation of Reference Input Voltage over Temperature	V <sub>dev</sub>		4.0	8.0	mV	I <sub>L</sub> =10mA, V <sub>Z</sub> =V <sub>ref</sub> T <sub>a</sub> =full range (Fig1)
Ratio of the change in Reference Voltage to the Change in Cathode Voltage	$\frac{\Delta V_{ref}}{\Delta V_Z}$		0.5	2.0	mV/V	V <sub>Z</sub> from V <sub>ref</sub> to 10V I <sub>Z</sub> =10mA (Fig2)
Reference Input Current	I <sub>ref</sub>	0.02	0.11	0.4	μA	R1=10k, R2=OC, I <sub>L</sub> =10mA (Fig2)
Deviation of Reference Input Current over Temperature	ΔI <sub>ref</sub>		0.02	0.2	μA	R1=10k, R2=O/C, I <sub>L</sub> =10mA T <sub>a</sub> =full range (Fig2)
Minimum Cathode Current for Regulation	I <sub>Zmin</sub>		30	100	μA	
Off-state Current	I <sub>Zoff</sub>		10	30	μA	V <sub>Z</sub> =10V, V <sub>ref</sub> =0V (Fig3)
Dynamic Output Impedance	R <sub>Z</sub>		0.25	2	Ω	V <sub>Z</sub> =V <sub>ref</sub> (Fig1), f=0Hz, I <sub>L</sub> =10mA

Deviation of reference input voltage, V<sub>dev</sub>, is defined as the maximum variation of the reference input voltage over the full temperature range.

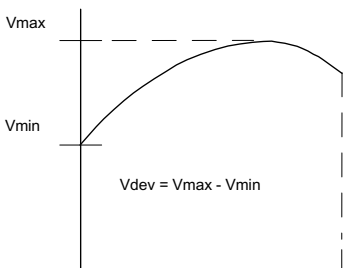

The average temperature coefficient of the reference input voltage, V<sub>ref</sub> is defined as:

$$V_{ref} (ppm/^{\circ}C) = \frac{V_{dev} \times 1000000}{V_{ref} (T1 - T2)}$$

The dynamic output impedance, R<sub>Z</sub>, is defined as:

$$R_Z = \frac{\Delta V_Z}{\Delta I_Z}$$

When the device is programmed with two external resistors, R<sub>1</sub> and R<sub>2</sub>, (fig 2), the dynamic output impedance of the overall circuit, R', is defined as:

$$R' = R_1 \parallel R_2$$

**ZR431L**

## CONNECTION DIAGRAMS

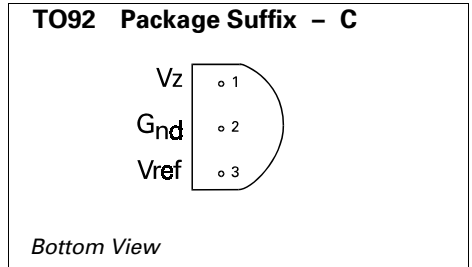
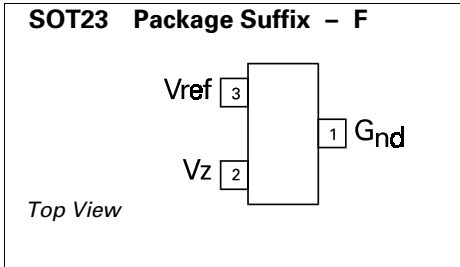

## ORDERING INFORMATION

Part Number	Package	Tol %	Part Mark
ZR431LF02	SOT23	2.5	43L
ZR431LF01	SOT23	1	43M
ZR431LC02	TO92	2.5	ZR431L02
ZR431LC01	TO92	1	ZR431L01

# ZR431L

## TYPICAL CHARACTERISTICS

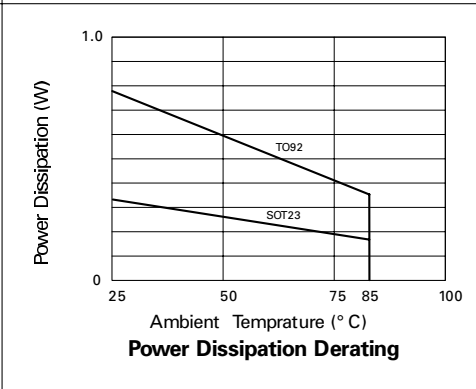
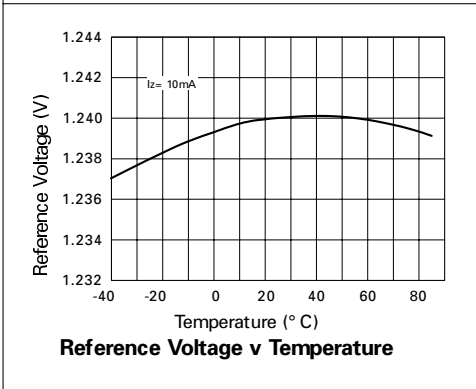
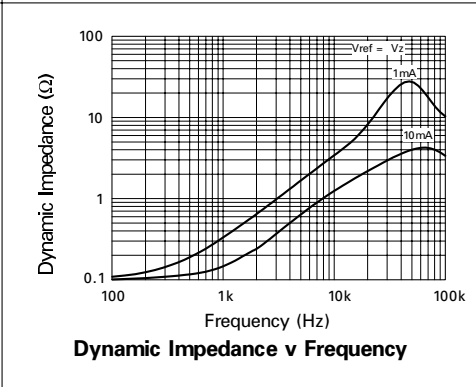
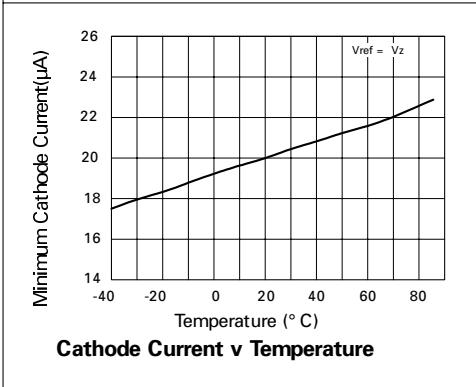
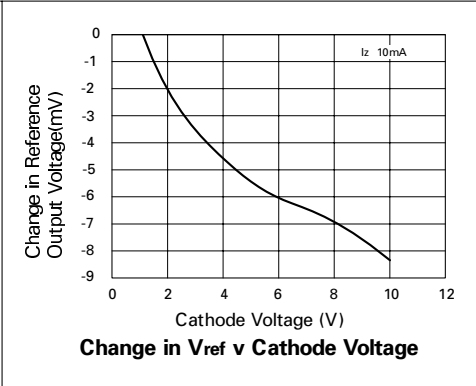
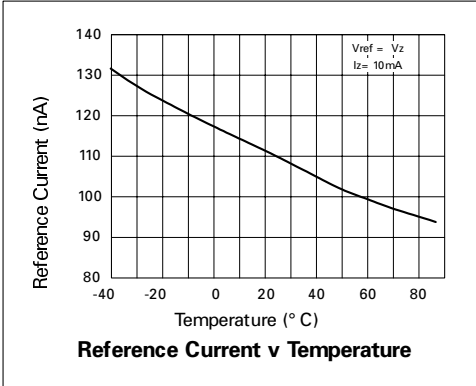

# ZR431L

## DC TEST CIRCUITS

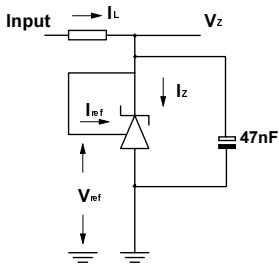

Fig 1 – Test Circuit for  $V_z = V_{ref}$

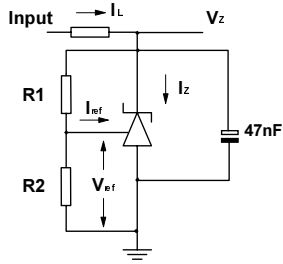

Fig 2 – Test Circuit for  $V_z > V_{ref}$

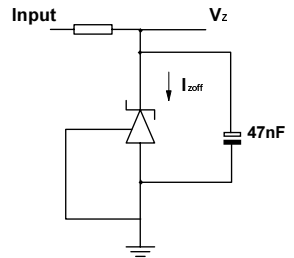
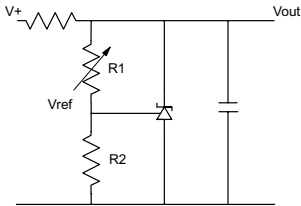

Fig 3 – Test Circuit for Off State current

# ZR431L

## APPLICATION CIRCUITS



$$V_{out} = \left( 1 + \frac{R1}{R2} \right) V_{ref}$$

SHUNT REGULATOR

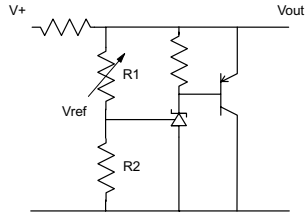

$$V_{out} = \left( 1 + \frac{R1}{R2} \right) V_{ref}$$

HIGHER CURRENT SHUNT REGULATOR

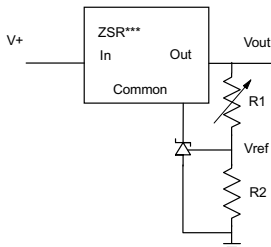

$$V_{out\_MIN} = V_{ref} + V_{reg}$$

$$V_{out} = \left( 1 + \frac{R1}{R2} \right) V_{ref}$$

OUTPUT CONTROL OF A THREE TERMINAL FIXED REGULATOR

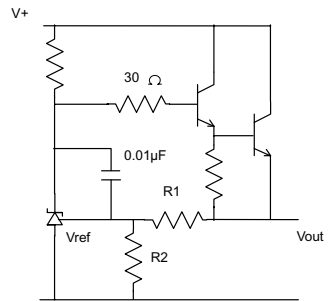

$$V_{out} = \left( 1 + \frac{R1}{R2} \right) V_{ref}$$

SERIES REGULATOR

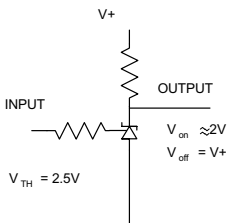

SINGLE SUPPLY COMPARATOR WITH TEMPERATURE COMPENSATED THRESHOLD

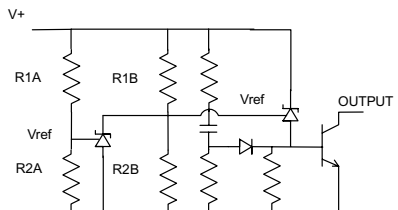

$$\text{Low limit} = \left( 1 + \frac{R1B}{R2B} \right) V_{ref}$$

$$\text{High limit} = \left( 1 + \frac{R1A}{R2A} \right) V_{ref}$$

OVER VOLTAGE / UNDER VOLTAGE

# ZR431L

## TYPICAL CHARACTERISTICS

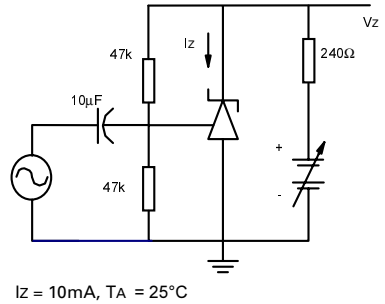
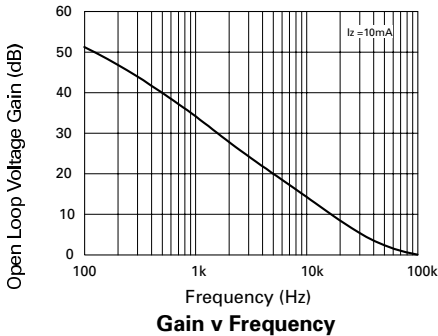

**Test Circuit for Open Loop Voltage Gain**

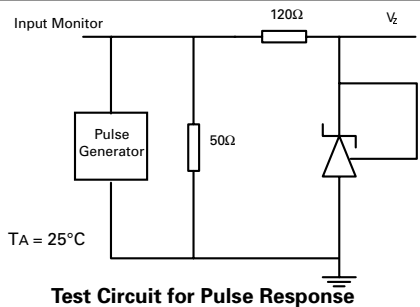
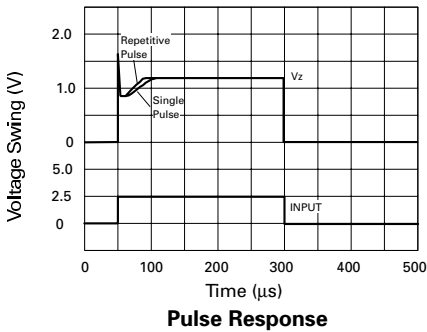

**Test Circuit for Pulse Response**

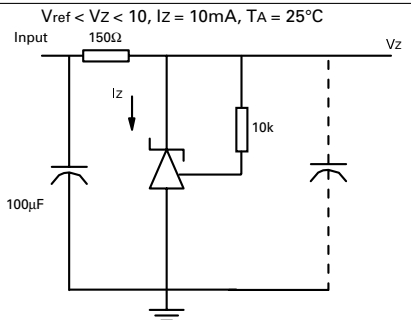
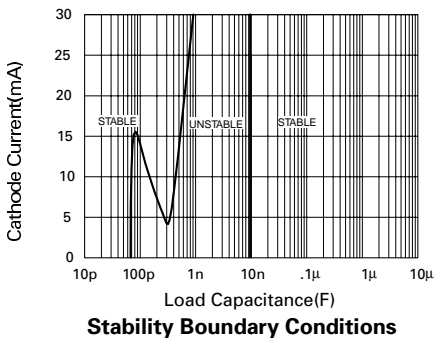

**Test Circuit for Stability Boundary Conditions**