

# SUPPLY VOLTAGE MONITOR

ISSUE 1 – NOVEMBER 1995

## DEVICE DESCRIPTION

The ZSM300 is a three terminal under voltage monitor circuit for use in microprocessor systems. The threshold voltage of the device has been set to 2.63 volts making it ideal for 3 volt circuits.

Included in the device is a precise voltage reference and a comparator with built in hysteresis to prevent erratic operation. The ZSM300 features an open collector output capable of sinking at least 10mA which only requires a single external resistor to interface to following circuits.

Operation of the device is guaranteed from one volt upwards, from this level to the device threshold voltage the output is held low providing a power on reset function. Should the supply voltage, once established, at any time drop below the threshold level then the output again will pull low.

The device is available in a TO92 package for through hole applications as well as SO8 and SOT223 for surface mount requirements.

## FEATURES

- SO8, SOT223 and TO92 packages
- Power on reset generator
- Automatic reset generation
- Low standby current
- Guaranteed operation from 1 volt
- Wide supply voltage range
- Internal clamp diode to discharge delay capacitor
- 2.63 volt threshold for 3 volt logic
- 20mV hysteresis prevents erratic operation

## APPLICATIONS

- Microprocessor systems
- Computers
- Computer peripherals
- Instrumentation
- Automotive
- Battery powered equipment

## SCHEMATIC DIAGRAM

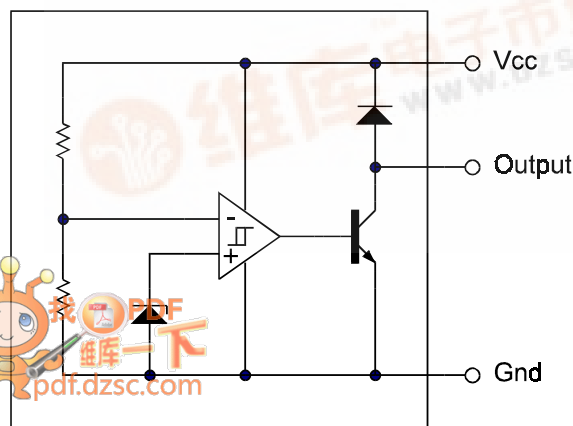

# ZSM300

## ABSOLUTE MAXIMUM RATING

Input Supply Voltage	-1 to 10V
Offstate Output Voltage	10V
Onstate Output Sink Current(Note 1)	Internally limited
Clamp Diode Forward Current(Note 1)	100mA
Operating Junction Temperature	150°C
Operating Temperature	-40 to 85°C
Storage Temperature	-55 to 150°C

## Power Dissipation

TO92	780mW
SOT223	2W(Note 2)
SO8	780mW(Note 2)

## TEST CONDITIONS

( $T_{amb}=25^{\circ}\text{C}$  for typical values,  $T_{amb}=-40$  to  $85^{\circ}\text{C}$  for min/max values (Note3))

## COMPARATOR

PARAMETER	SYMBOL	MIN	TYP.	MAX.	UNITS
Threshold Voltage High state output ( $V_{cc}$ increasing)	$V_{IH}$	2.56	2.64	2.7	V
Threshold Voltage Low state output ( $V_{cc}$ decreasing)	$V_{IL}$	2.56	2.62	2.7	V
Hysteresis	$V_H$	0.01	0.02	0.05	V

## OUTPUT

Output sink saturation: ( $V_{cc}=2.2\text{V}$ , $I_{sink}=8.0\text{mA}$ ) ( $V_{cc}=2.2\text{V}$ , $I_{sink}=2.0\text{mA}$ ) ( $V_{cc}=1.0\text{V}$ , $I_{sink}=0.1\text{mA}$ )	$V_{OL}$		0.46 0.15	1.0 0.4 0.25	V V V
Onstate output sink current ( $V_{cc}$ , Output=2.2V)	$I_{sink}$	10	27	60	mA
Offstate output leakage current ( $V_{cc}$ , Output=3V)	$I_{oh}$		0.02	0.5	$\mu\text{A}$
Clamp diode forward voltage ( $I_f=10\text{mA}$ )	$V_f$	0.6	1.2	1.5	V
Propagation delay ( $V_{in}$ 3V to 2.2V, $R_I=10\text{k}$ , $T_{amb}=25^{\circ}\text{C}$ )	$T_d$		2.5		$\mu\text{s}$

## TOTAL DEVICE

Operating input voltage range	$V_{cc}$	1.0 to 6.5			V
Quiescent input current ( $V_{cc}=3\text{V}$ )	$I_q$		125	190	$\mu\text{A}$

### Note:

- Maximum package power dissipation must be observed.
- Maximum power dissipation, for the SOT223 and SO8 packages, is calculated assuming that the device is mounted on a PCB measuring 2 inches square.
- Low duty cycle pulse techniques are used during test to maintain junction temperatures as close to ambient as possible.

# ZSM300

## TYPICAL CHARACTERISTICS

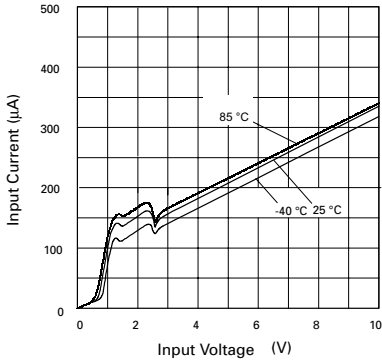

**Input Current vs. Input Voltage**

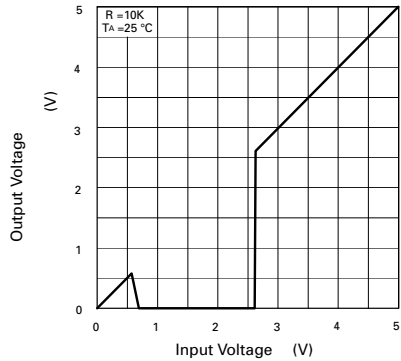

**Output Voltage vs. Input Voltage**

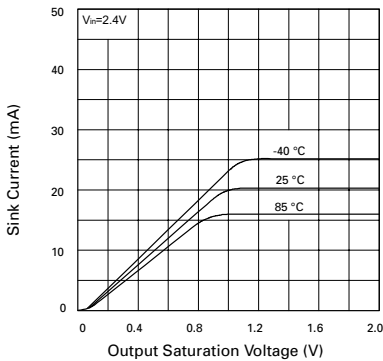

**Output Saturation Voltage vs. Sink Current**

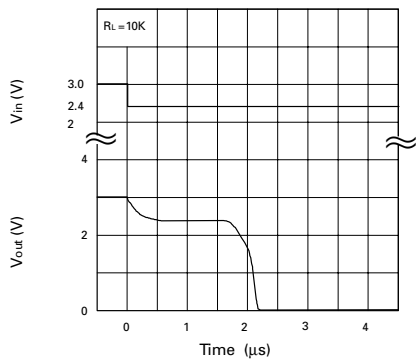

**Reset Delay Time**

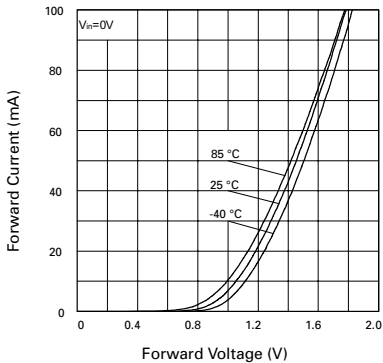

**Forward Current vs. Forward Voltage**

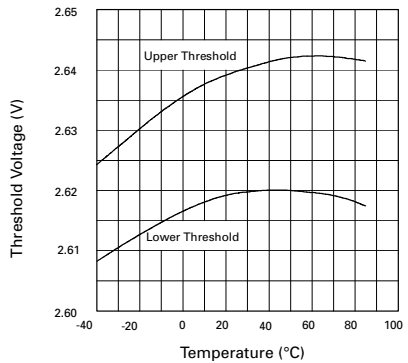

**Threshold Voltage vs. Temperature**

# ZSM300

## TIMING DIAGRAM

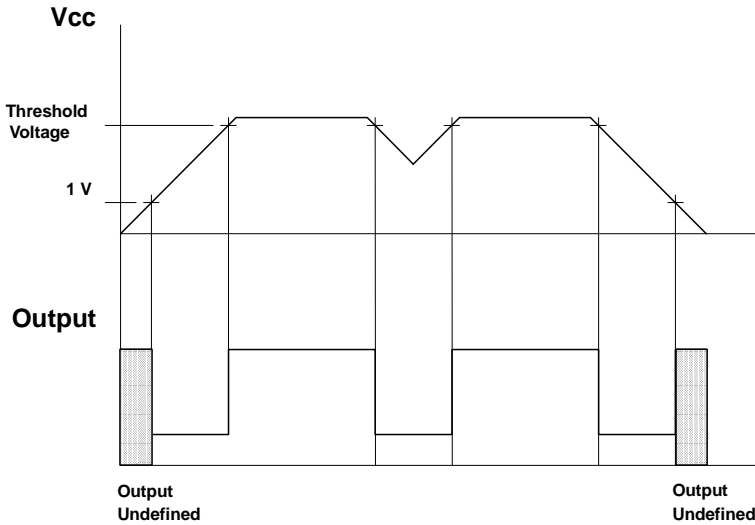

## APPLICATION CIRCUIT

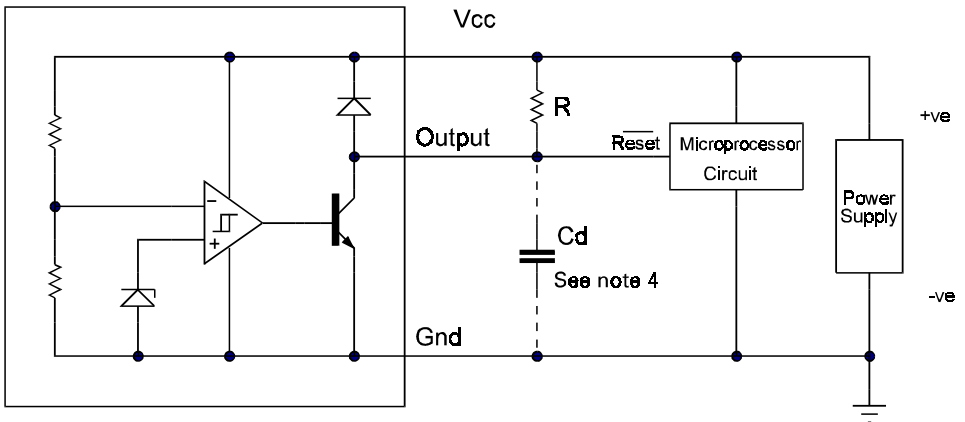

Note 4: A time delayed reset can be accomplished with the additional  $C_d$ .

$$T_{DY} = RCd \ln \left( \frac{1}{1 - \frac{V_{TH}(MPU)}{V_{in}}} \right)$$

$T_{DY}$  = Time (Seconds)  
 $V_{TH}$  = Microprocessor Reset Threshold  
 $V_{in}$  = Power Supply Voltage

# ZSM300

## CONNECTION DIAGRAMS

### SO8 Package Suffix – N8

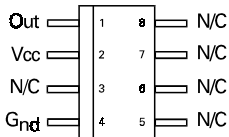

Top View

### SOT223 Package Suffix – G

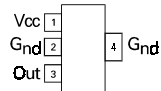

Top View –  
Pin 4 floating or connected to pin 2

### T092 Package Suffix – C

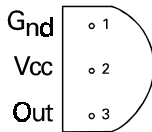

Bottom View

## ORDERING INFORMATION

Part Number	Package	Part Mark
ZSM300N8	SO8	ZSM300
ZSM300G	SOT223	ZSM300
ZSM300C	T092	ZSM300