



ZXM62P03E6

30V P-CHANNEL ENHANCEMENT MODE MOSFET

SUMMARY

$V_{(BR)DSS} = -30V$; $R_{DS(ON)} = 0.15\Omega$; $I_D = -2.6A$

DESCRIPTION

This new generation of high density MOSFETs from Zetex utilizes a unique structure that combines the benefits of low on-resistance with fast switching speed. This makes them ideal for high efficiency, low voltage, power management applications.

FEATURES

- Low on-resistance
- Fast switching speed
- Low threshold
- Low gate drive
- SOT23-6 package

APPLICATIONS

- DC - DC Converters
- Power Management Functions
- Disconnect switches
- Motor control

ORDERING INFORMATION

DEVICE	REEL SIZE (inches)	TAPE WIDTH (mm)	QUANTITY PER REEL
ZXM62P03E6TA	7	8mm embossed	3000 units
ZXM62P03E6TC	13	8mm embossed	10000 units

DEVICE MARKING

- 2P03

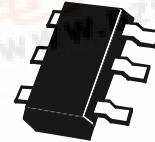

SOT23-6

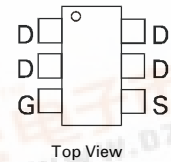
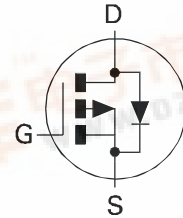

ZXM62P03E6

ABSOLUTE MAXIMUM RATINGS.

PARAMETER	SYMBOL	LIMIT	UNIT
Drain-Source Voltage	V_{DSS}	-30	V
Gate- Source Voltage	V_{GS}	± 20	V
Continuous Drain Current ($V_{GS}=-10V$; $T_A=25^\circ C$)(b) ($V_{GS}=-10V$; $T_A=70^\circ C$)(b)	I_D	-2.6 -2.0	A
Pulsed Drain Current (c)	I_{DM}	-13	A
Continuous Source Current (Body Diode)(b)	I_S	-1.9	A
Pulsed Source Current (Body Diode)(c)	I_{SM}	-13	A
Power Dissipation at $T_A=25^\circ C$ (a) Linear Derating Factor	P_D	1.1 8.8	W mW/ $^\circ C$
Power Dissipation at $T_A=25^\circ C$ (b) Linear Derating Factor	P_D	1.7 13.6	W mW/ $^\circ C$
Operating and Storage Temperature Range	T_j ; T_{stg}	-55 to +150	$^\circ C$

THERMAL RESISTANCE

PARAMETER	SYMBOL	VALUE	UNIT
Junction to Ambient (a)	$R_{\theta JA}$	113	$^\circ C/W$
Junction to Ambient (b)	$R_{\theta JA}$	73	$^\circ C/W$

NOTES

(a) For a device surface mounted on 25mm x 25mm FR4 PCB with high coverage of single sided 1oz copper, in still air conditions

(b) For a device surface mounted on FR4 PCB measured at $t \leq 5$ secs.

(c) Repetitive rating - pulse width limited by maximum junction temperature. Refer to Transient Thermal Impedance graph.

ZXM62P03E6

CHARACTERISTICS

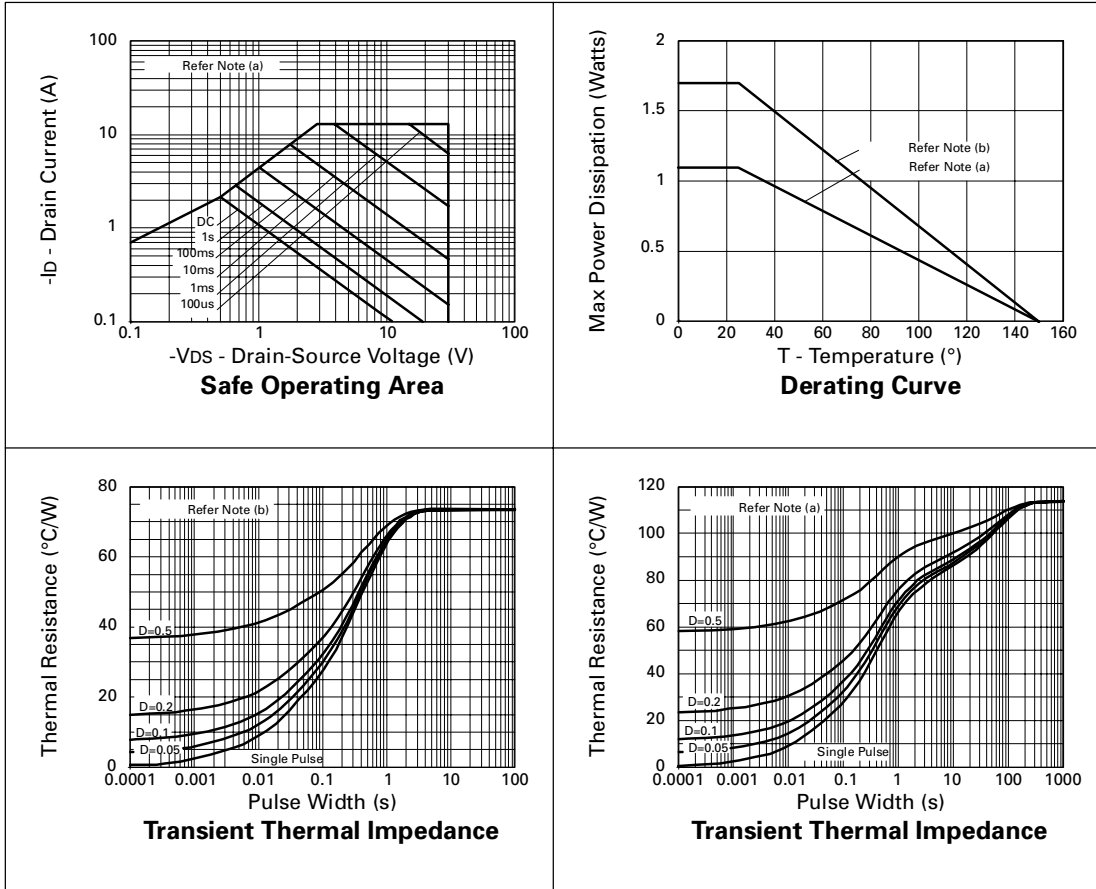

ZXM62P03E6

ELECTRICAL CHARACTERISTICS (at $T_{amb} = 25^{\circ}\text{C}$ unless otherwise stated).

PARAMETER	SYMBOL	MIN.	TYP.	MAX.	UNIT	CONDITIONS.
STATIC						
Drain-Source Breakdown Voltage	$V_{(BR)DSS}$	-30			V	$I_D = -250\mu\text{A}$, $V_{GS} = 0\text{V}$
Zero Gate Voltage Drain Current	I_{DSS}			-1	μA	$V_{DS} = -30\text{V}$, $V_{GS} = 0\text{V}$
Gate-Body Leakage	I_{GSS}			± 100	nA	$V_{GS} = \pm 20\text{V}$, $V_{DS} = 0\text{V}$
Gate-Source Threshold Voltage	$V_{GS(th)}$	-1.0			V	$I_D = -250\mu\text{A}$, $V_{DS} = V_{GS}$
Static Drain-Source On-State Resistance (1)	$R_{DS(on)}$			0.15 0.23	Ω Ω	$V_{GS} = -10\text{V}$, $I_D = -1.6\text{A}$ $V_{GS} = -4.5\text{V}$, $I_D = -0.8\text{A}$
Forward Transconductance (3)	g_{fs}	1.1			S	$V_{DS} = -10\text{V}$, $I_D = -0.8\text{A}$
DYNAMIC (3)						
Input Capacitance	C_{iss}		330		pF	$V_{DS} = -25\text{V}$, $V_{GS} = 0\text{V}$, $f = 1\text{MHz}$
Output Capacitance	C_{oss}		120		pF	
Reverse Transfer Capacitance	C_{rss}		45		pF	
SWITCHING(2) (3)						
Turn-On Delay Time	$t_{d(on)}$		2.8		ns	$V_{DD} = -15\text{V}$, $I_D = -1.6\text{A}$ $R_G = 6.2\Omega$, $R_D = 25\Omega$ (Refer to test circuit)
Rise Time	t_r		6.4		ns	
Turn-Off Delay Time	$t_{d(off)}$		13.9		ns	
Fall Time	t_f		10.3		ns	
Total Gate Charge	Q_g			10.2	nC	$V_{DS} = -24\text{V}$, $V_{GS} = -10\text{V}$, $I_D = -1.6\text{A}$ (Refer to test circuit)
Gate-Source Charge	Q_{gs}			1.5	nC	
Gate Drain Charge	Q_{gd}			3	nC	
SOURCE-DRAIN DIODE						
Diode Forward Voltage (1)	V_{SD}			-0.95	V	$T_j = 25^{\circ}\text{C}$, $I_S = -1.6\text{A}$, $V_{GS} = 0\text{V}$
Reverse Recovery Time (3)	t_{rr}		19.9		ns	$T_j = 25^{\circ}\text{C}$, $I_F = -1.6\text{A}$, $di/dt = 100\text{A}/\mu\text{s}$
Reverse Recovery Charge(3)	Q_{rr}		13		nC	

(1) Measured under pulsed conditions. Width=300 μs . Duty cycle $\leq 2\%$.

(2) Switching characteristics are independent of operating junction temperature.

(3) For design aid only, not subject to production testing.

ZXM62P03E6

TYPICAL CHARACTERISTICS

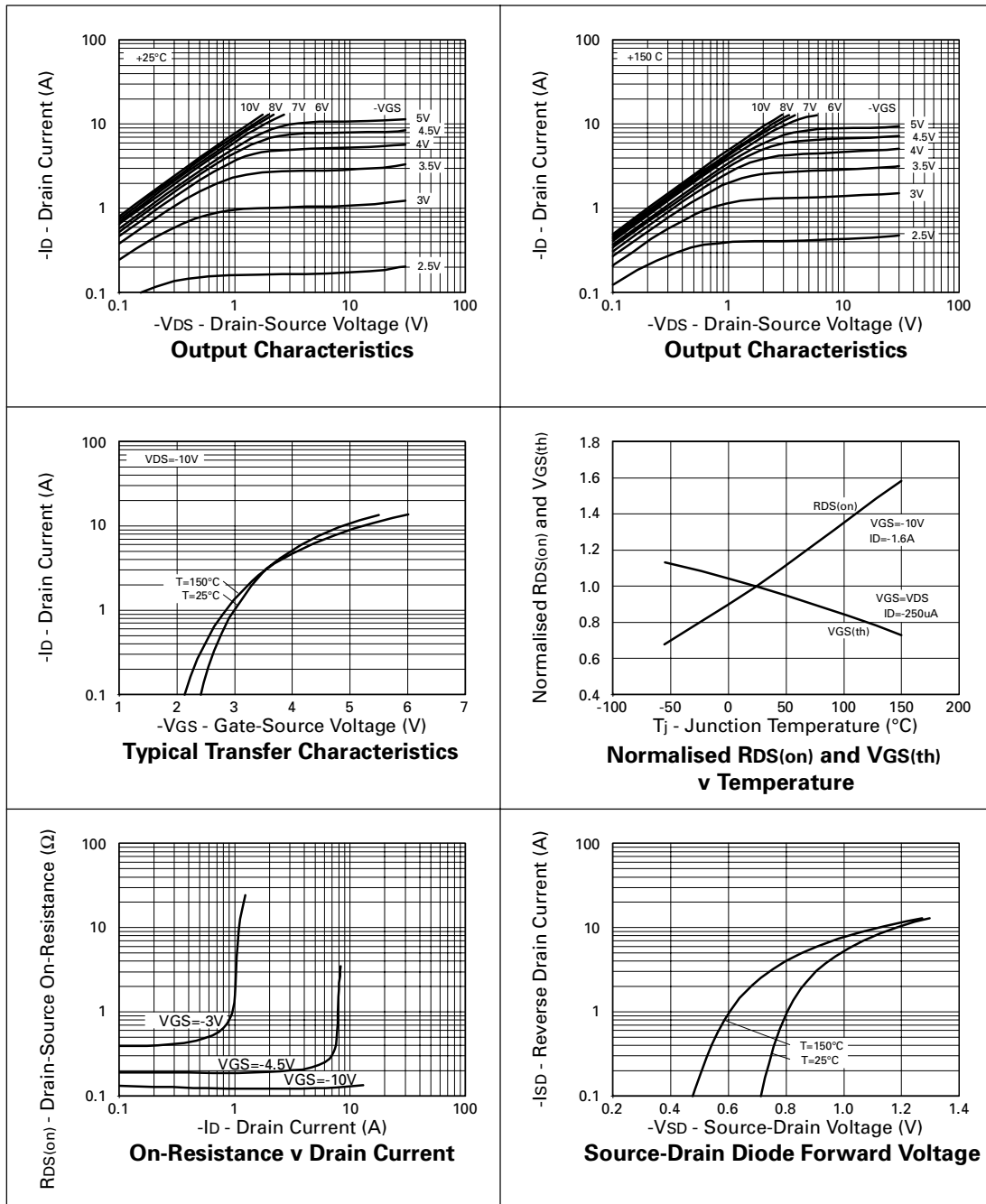

ZXM62P03E6

TYPICAL CHARACTERISTICS

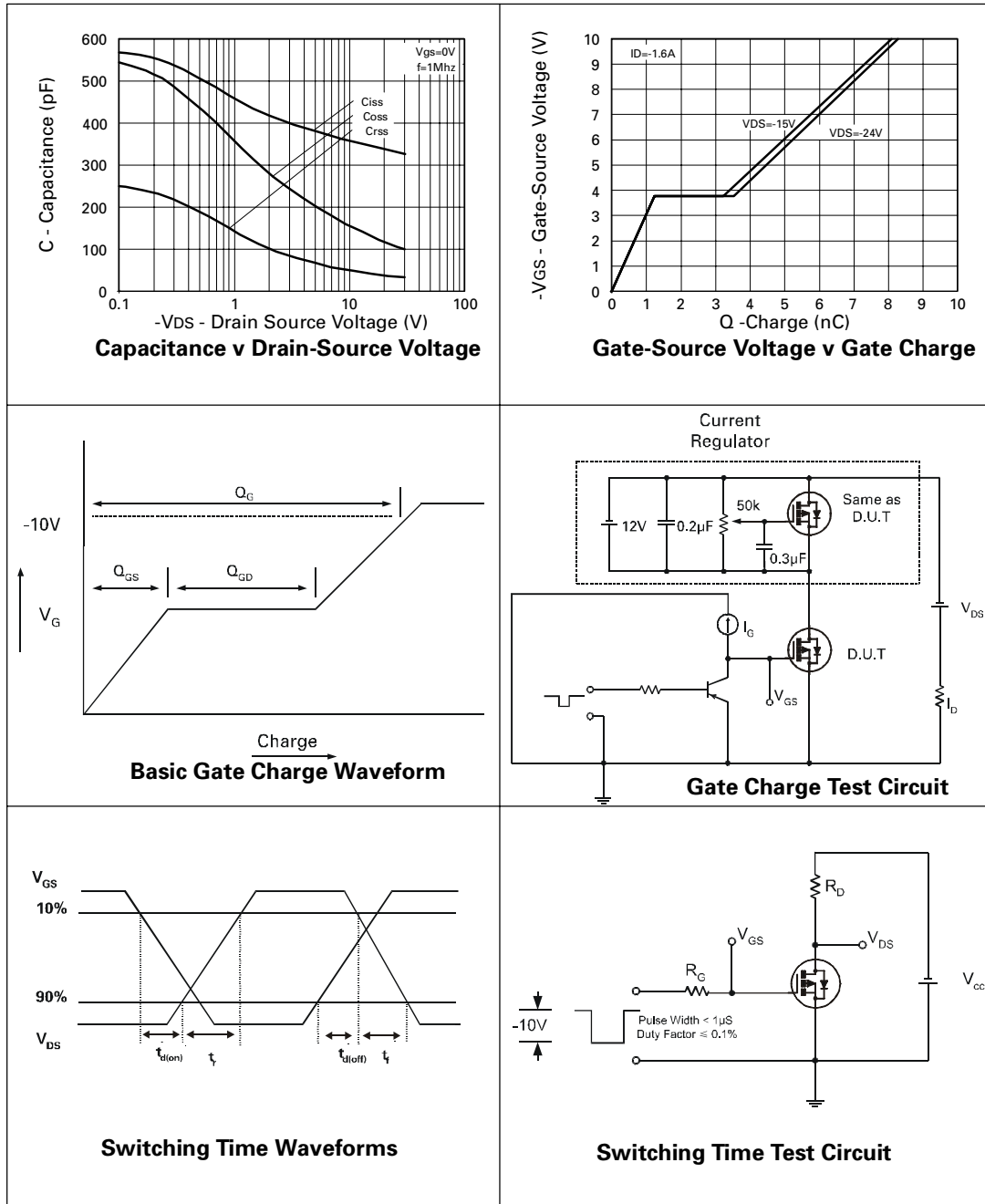

ZXM62P03E6

PACKAGE DIMENSIONS

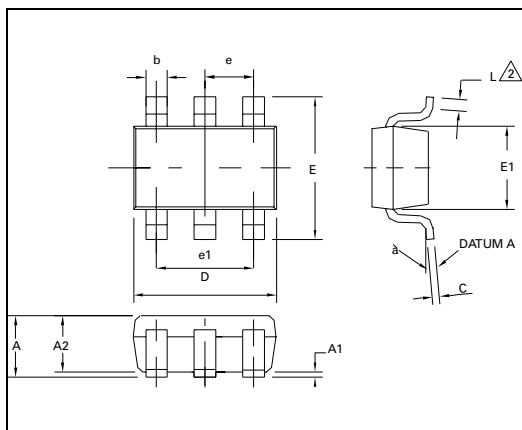

PAD LAYOUT DETAILS

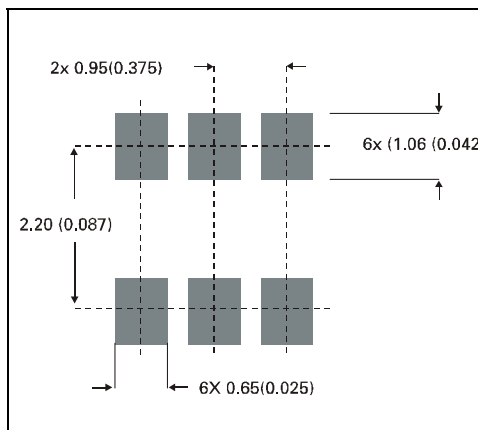

DIM	Millimetres		Inches	
	Min	Max	Min	Max
A	0.90	1.45	0.35	0.057
A1	0.00	0.15	0	0.006
A2	0.90	1.30	0.035	0.051
b	0.35	0.50	0.014	0.019
C	0.09	0.20	0.0035	0.008
D	2.80	3.00	0.110	0.118
E	2.60	3.00	0.102	0.118
E1	1.50	1.75	0.059	0.069
L	0.10	0.60	0.004	0.002
e	0.95 REF		0.037 REF	
e1	1.90 REF		0.074 REF	
L	0°	10°	0°	10°

ZETEX Zetex plc.
 Fields New Road, Chadderton, Oldham, OL9-8NP, United Kingdom.
 Telephone: (44)161 622 4422 (Sales), (44)161 622 4444 (General Enquiries)
 Fax: (44)161 622 4420

Zetex GmbH
 Streitfeldstraße 19
 D-81673 München
 Germany
 Telefon: (49) 89 45 49 49 0
 Fax: (49) 89 45 49 49 49

Zetex Inc.
 47 Mall Drive, Unit 4
 Commack NY 11725
 USA
 Telephone: (516) 543-7100
 Fax: (516) 864-7630

Zetex (Asia) Ltd.
 3510 Metroplaza, Tower 2
 Hing Fong Road,
 Kwai Fong, Hong Kong
 Telephone: (852) 26100 611
 Fax: (852) 24250 494

These are supported by
 agents and distributors in
 major countries world-wide
 ©Zetex plc 1999

Internet: <http://www.zetex.com>

This publication is issued to provide outline information only which (unless agreed by the Company in writing) may not be used, applied or reproduced for any purpose or form part of any order or contract or be regarded as a representation relating to the products or services concerned. The Company reserves the right to alter without notice the specification, design, price or conditions of supply of any product or service.