

---

# Precision Optical Performance AlInGaP II LED Lamps

## Technical Data

HLMP-ELxx  
HLMP-EHxx  
HLMP-EDxx

---

### Features

- **Well Defined Spatial Radiation Patterns**
- **Viewing Angles:** 15°, 23°, 30°
- **High Luminous Output**
- **Colors:**  
592 nm Amber  
617 nm Reddish-Orange  
630 nm Red
- **High Operating Temperature:**  
 $T_{JLED} = +130^{\circ}C$
- **Superior Resistance to Moisture**

### Benefits

- **Viewing Angles Match Traffic Management Requirements**
- **Colors Meet Automotive and Traffic Signal Specifications**
- **Superior Light Output Performance in Outdoor Environments**
- **Suitable for Autoinsertion into PC Boards**

### Applications

- **Traffic Management:**  
Traffic Signals  
Work Zone Warning Lights  
Variable Message Signs
- **Commercial Outdoor Advertising:**  
Signs  
Marquees
- **Automotive:**  
Exterior and Interior Lights

### Description

Precision Optical Performance AlInGaP II (aluminum indium gallium phosphide) LEDs offer superior light output for excellent readability in sunlight and dependable performance. The AlInGaP II technology provides extremely stable light output over long periods of time.

These LED lamps are untinted, nondiffused, T-1<sup>3/4</sup> packages incorporating second generation optics which produce well defined radiation patterns at specific viewing cone angles.



These lamps are made with an advanced optical grade epoxy offering superior high temperature and high moisture resistance performance in outdoor signal and sign applications. The maximum LED junction temperature limit of +130° C enables high temperature operation in bright sunlight conditions. The epoxy contains both uv-a and uv-b inhibitors to reduce the effects of long term exposure to direct sunlight.

[查询"HLMP-ED18-PX400"供应商](#)

## T-1<sup>3</sup>/<sub>4</sub> (5 mm) Precision Optical Performance AlInGaP II LED Lamps

### Selection Guide

Typical Viewing Angle 2θ <sup>1/2</sup> (Deg.) <sup>[2]</sup>	Color and Dominant Wavelength (nm), Typ. <sup>[1]</sup>	Lamps Without Standoffs (Outline Drawing A)	Lamps With Standoffs (Outline Drawing B)	Luminous Intensity I <sub>v</sub> (mcd) <sup>[3,4,5]</sup> @ I(f) = 20 mA		
				Min.	Max.	
15°	Amber 592	HLMP-EL16-TW000	HLMP-EL18-TW000	2500	7200	
		HLMP-EL16-TWR00	HLMP-EL18-TWR00	2500	7200	
		HLMP-EL16-TWK00*		2500	7200	
		HLMP-EL16-TWS00		2500	7200	
		HLMP-EL16-TUS00		2500	4200	
		HLMP-EL16-TV400**		2500	5500	
		HLMP-EL16-TVU00		2500	5500	
		HLMP-EL16-UX000	HLMP-EL18-UX000	3200	9300	
		HLMP-EL16-UXR00	HLMP-EL18-UXR00	3200	9300	
		HLMP-EL16-VW000		4200	7200	
		HLMP-EL16-VWR000		4200	7200	
		HLMP-EL16-VWK00*		4200	7200	
		HLMP-EL16-VWS00		4200	7200	
		HLMP-EL16-VX000		4200	9300	
		HLMP-EL16-VXR00		4200	9300	
		HLMP-EL16-VX400**		4200	9300	
		HLMP-EL16-VXK00*		4200	9300	
		HLMP-EL16-VXS00		4200	9300	
		<b>HLMP-EL16-VY000</b>	HLMP-EL18-VY000	4200	12000	
		HLMP-EL16-VYR00	HLMP-EL18-VYR00	4200	12000	
	HLMP-EL16-VYK00*		4200	12000		
	HLMP-EL16-VYS00		4200	12000		
	Red-Orange 615			HLMP-EH18-TW000	2500	7200
			HLMP-EH16-UX000	HLMP-EH18-UX000	3200	9300
	Red 630	<b>HLMP-ED16-TW000</b>		HLMP-ED18-TW000	2500	7200
		HLMP-ED16-TWT00		HLMP-ED18-TWT00	2500	7200
		HLMP-ED16-UX000		HLMP-ED18-UX000	3200	9300
		HLMP-ED16-UXT00		HLMP-ED18-UXT00	3200	9300

[查询"HLMP-ED18-PX400"供应商](#)

### T-1<sup>3</sup>/<sub>4</sub> (5 mm) Precision Optical Performance AlInGaP II Led Lamps (Continued)

#### Selection Guide

Typical Viewing Angle 2θ <sup>1/2</sup> (Deg.) <sup>[2]</sup>	Color and Dominant Wavelength (nm), Typ. <sup>[1]</sup>	Lamps Without Standoffs (Outline Drawing A)	Lamps With Standoffs (Outline Drawing B)	Luminous Intensity I <sub>v</sub> (mcd) <sup>[3,4]</sup> @ I(f) = 20 mA	
				Min.	Max
23°	Amber 592	HLMP-EL25-QS400**		1150	2500
		HLMP-EL25-QSU00		1150	2500
		HLMP-EL25-QSK00*		1150	2500
		HLMP-EL25-QSS00		1150	2500
		HLMP-EL25-QT000		1150	3200
		HLMP-EL25-QTR00	HLMP-EL27-QTR00	1150	3200
		HLMP-EL25-RU000	HLMP-EL27-RU000	1500	4200
		HLMP-EL25-RUR00	HLMP-EL27-RUR00	1500	4200
		HLMP-EL25-RUK00*		1500	4200
		HLMP-EL25-RUS00		1500	4200
		HLMP-EL25-ST000		1900	3200
		HLMP-EL25-STR00		1900	3200
		HLMP-EL25-STK00*		1900	3200
		HLMP-EL25-STS00		1900	3200
		HLMP-EL25-SU000		1900	4200
		HLMP-EL25-SUR00		1900	4200
		HLMP-EL25-SU400**		1900	4200
		HLMP-EL25-SUU00		1900	4200
		HLMP-EL25-SUK00*		1900	4200
		HLMP-EL25-SUS00		1900	4200
		HLMP-EL25-SVK00*		1900	5500
		HLMP-EL25-SVS00		1900	5500
		HLMP-EL25-SV000	HLMP-EL27-SV000	1900	5500
		HLMP-EL25-SVR00	HLMP-EL27-SVR00	1900	5500
		<b>HLMP-EL25-TW000</b>	HLMP-EL27-TW000	2500	7200
		HLMP-EL25-TWR00	HLMP-EL27-TWR00	2500	7200
HLMP-EL25-TWK00*		2500	7200		
HLMP-EL25-TWS00		2500	7200		

#### Notes:

1. Dominant Wavelength, λ<sub>d</sub>, is derived from the CIE Chromaticity Diagram and represents the color of the lamp.
2. θ<sub>1/2</sub> is the off-axis angle where the luminous intensity is one half the on-axis intensity.
3. The luminous intensity is measured on the mechanical axis of the lamp package.
4. The optical axis is closely aligned with the package mechanical axis.

5. Tolerance for each intensity bin limit is ± 15%.

Part numbers in **bold** are recommended for new designs.

\*HLMP-xLxx-xxK00 are selected to amber color bins 2 and 4 only.

\*\*HLMP-xLxx-xx400 are selected to amber color bin 4 only.

[查询"HLMP-ED18-PX400"供应商](#)
**T-1<sup>3</sup>/<sub>4</sub> (5 mm) Precision Optical Performance AlInGaP II Led Lamps (Continued)**
**Selection Guide**

Typical Viewing Angle $2\theta_{1/2}$ (Deg.) <sup>[2]</sup>	Color and Dominant Wavelength (nm), Typ. <sup>[1]</sup>	Lamps Without Standoffs (Outline Drawing A)	Lamps With Standoffs (Outline Drawing B)	Luminous Intensity $I_v$ (mcd) <sup>[3,4]</sup> @ $I(f) = 20$ mA		
				Min.	Max	
23°	Red-Orange 615	HLMP-EH25-QT000		1150	3200	
		HLMP-EH25-RU000		1500	4200	
			HLMP-EH27-SV000	1900	5500	
		<b>HLMP-EH25-TW000</b>	HLMP-EH27-TW000	2500	7200	
	Red 630	HLMP-ED25-QT000		1150	3200	
		HLMP-ED25-QTT00		1150	3200	
		HLMP-ED25-RU000	HLMP-ED27-RU000	1500	4200	
		HLMP-ED25-RUT00	HLMP-ED27-RUT00	1500	4200	
		HLMP-ED25-SV000	HLMP-ED27-SV000	1900	5500	
		HLMP-ED25-SVT00	HLMP-ED27-SVT00	1900	5500	
		<b>HLMP-ED25-TW000</b>	HLMP-ED27-TW000	2500	7200	
		HLMP-ED25-TWT00	HLMP-ED27-TWT00	2500	7200	
	30°	Amber 592	HLMP-EL31-QRS00		1150	1900
			HLMP-EL31-QS000		1150	2500
HLMP-EL31-QSR00				1150	2500	
HLMP-EL31-QS400**				1150	2500	
HLMP-EL31-QSU00				1150	2500	
HLMP-EL31-QT000			HLMP-EL33-QT000	1150	3200	
HLMP-EL31-QTR00			HLMP-EL33-QTR00	1150	3200	
HLMP-EL31-QTK00*				1150	3200	
HLMP-EL31-QTS00				1150	3200	
<b>HLMP-EL31-SV000</b>			HLMP-EL33-SV000	1900	5500	
HLMP-EL31-SVR00			HLMP-EL33-SVR00	1900	5500	
HLMP-EL31-ST000				1900	3200	
HLMP-EL31-STR00				1900	3200	
HLMP-EL31-STK00*				1900	3200	
HLMP-EL31-STS00				1900	3200	
HLMP-EL31-SUK00*				1900	4200	

**Notes:**

1. Dominant Wavelength,  $\lambda_d$ , is derived from the CIE Chromaticity Diagram and represents the color of the lamp.
2.  $\theta_{1/2}$  is the off-axis angle where the luminous intensity is one half the on-axis intensity.
3. The luminous intensity is measured on the mechanical axis of the lamp package.
4. The optical axis is closely aligned with the package mechanical axis.

5. Tolerance for each intensity bin limit is  $\pm 15\%$ .

Part numbers in **bold** are recommended for new designs.  
 \*HLMP-xLxx-xxK00 are selected to amber color bins 2 and 4 only.  
 \*\*HLMP-xLxx-xx400 are selected to amber color bin 4 only.

[查询"HLMP-ED18-PX400"供应商](#)
**T-1<sup>3</sup>/<sub>4</sub> (5 mm) Precision Optical Performance AlInGaP II Led Lamps (Continued)**
**Selection Guide**

Typical Viewing Angle $2\theta^{1/2}$ (Deg.) <sup>[2]</sup>	Color and Dominant Wavelength (nm), Typ. <sup>[1]</sup>	Lamps Without Standoffs (Outline Drawing A)	Lamps With Standoffs (Outline Drawing B)	Luminous Intensity $I_v$ (mcd) <sup>[3,4]</sup> @ $I(f) = 20$ mA		
				Min.	Max.	
30°	Amber 592	HLMP-EL31-SUS00		1900	4200	
		HLMP-EL31-SU400**		1900	4200	
		HLMP-EL31-SUU00		1900	4200	
		HLMP-EL31-SU000		1900	4200	
		HLMP-EL31-SUR00		1900	4200	
		HLMP-EL31-SVK00*		1900	5500	
		HLMP-EL31-SVS00		1900	5500	
	Red-Orange 615	HLMP-EH31-PS000			880	2500
		HLMP-EH31-QT000	HLMP-EH33-QT000		1150	3200
		HLMP-EH31-RU000	HLMP-EH33-RU000		1500	4200
		<b>HLMP-EH31-SV000</b>	HLMP-EH33-SV000		1900	5500
		HLMP-EH31-SU000			1900	4200
	Red 630			HLMP-ED33-QT000	1150	3200
		HLMP-ED31-QTT00	HLMP-ED33-QTT00		1150	3200
		HLMP-ED31-ST000			1900	3200
		HLMP-ED31-STT00			1900	3200
		HLMP-ED31-SU000			1900	4200
		HLMP-ED31-SUT00			1900	4200
		HLMP-ED31-RU000	HLMP-ED33-RU000		1500	4200
		HLMP-ED31-RUT00	HLMP-ED33-RUT00		1500	4200
		HLMP-ED31-SV000	HLMP-ED33-SV000		1900	5500
		HLMP-ED31-SVT00	HLMP-ED33-SVT00		1900	5500

**Notes:**

1. Dominant Wavelength,  $\lambda_d$ , is derived from the CIE Chromaticity Diagram and represents the color of the lamp.
2.  $\theta_{1/2}$  is the off-axis angle where the luminous intensity is one half the on-axis intensity.
3. The luminous intensity is measured on the mechanical axis of the lamp package.
4. The optical axis is closely aligned with the package mechanical axis.
5. Tolerance for each intensity bin limit is  $\pm 15\%$ .

Part numbers in **bold** are recommended for new designs.

\*HLMP-xLxx-xxK00 are selected to amber color bins 2 and 4 only.

\*\*HLMP-xLxx-xx400 are selected to amber color bin 4 only.

[查询"HLMP-ED18-PX400"供应商](#)

## Part Numbering System

HLMP- x x xx - x x x xx

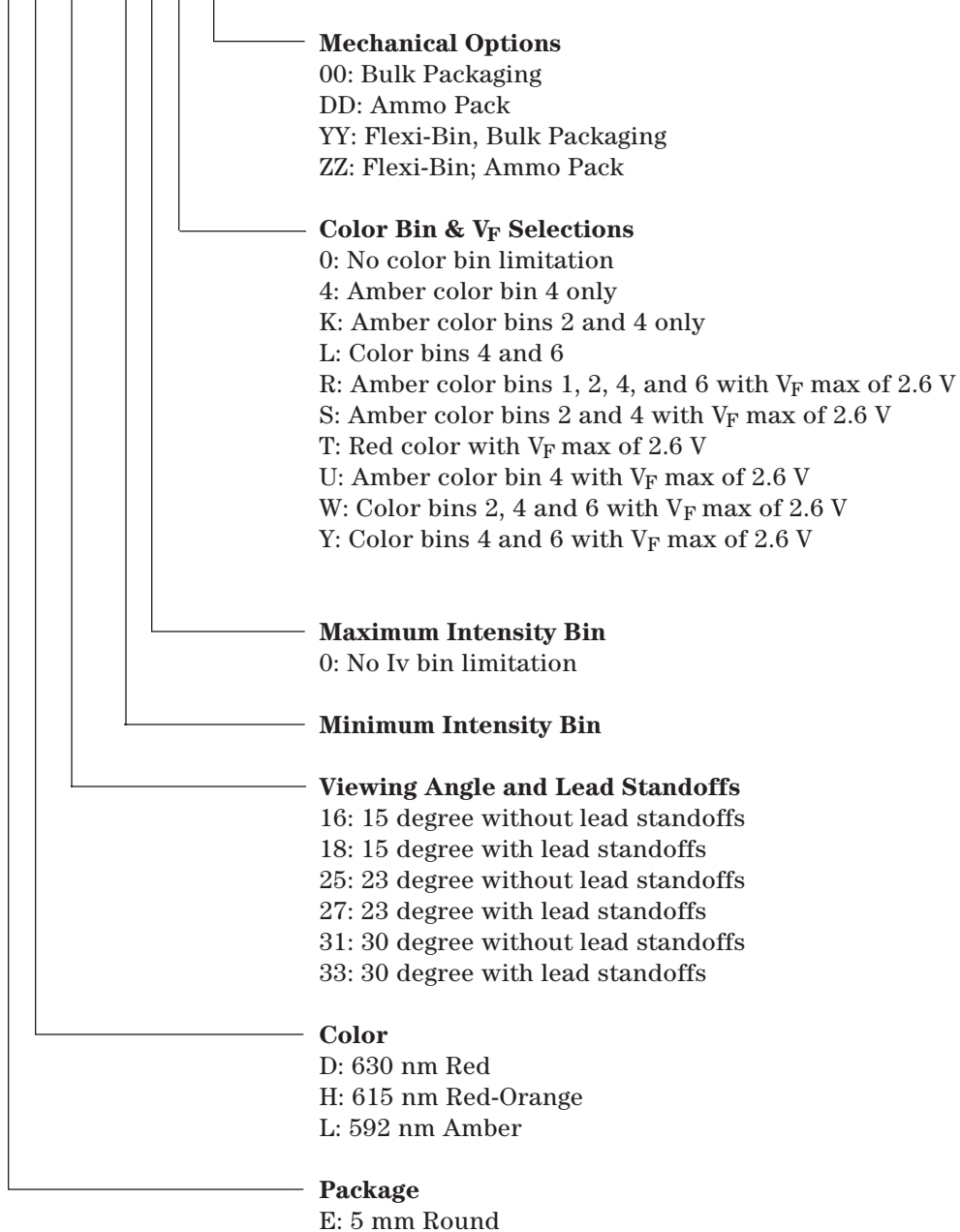

查询"HLMP-ED18-PX400"供应商

## Package Dimensions

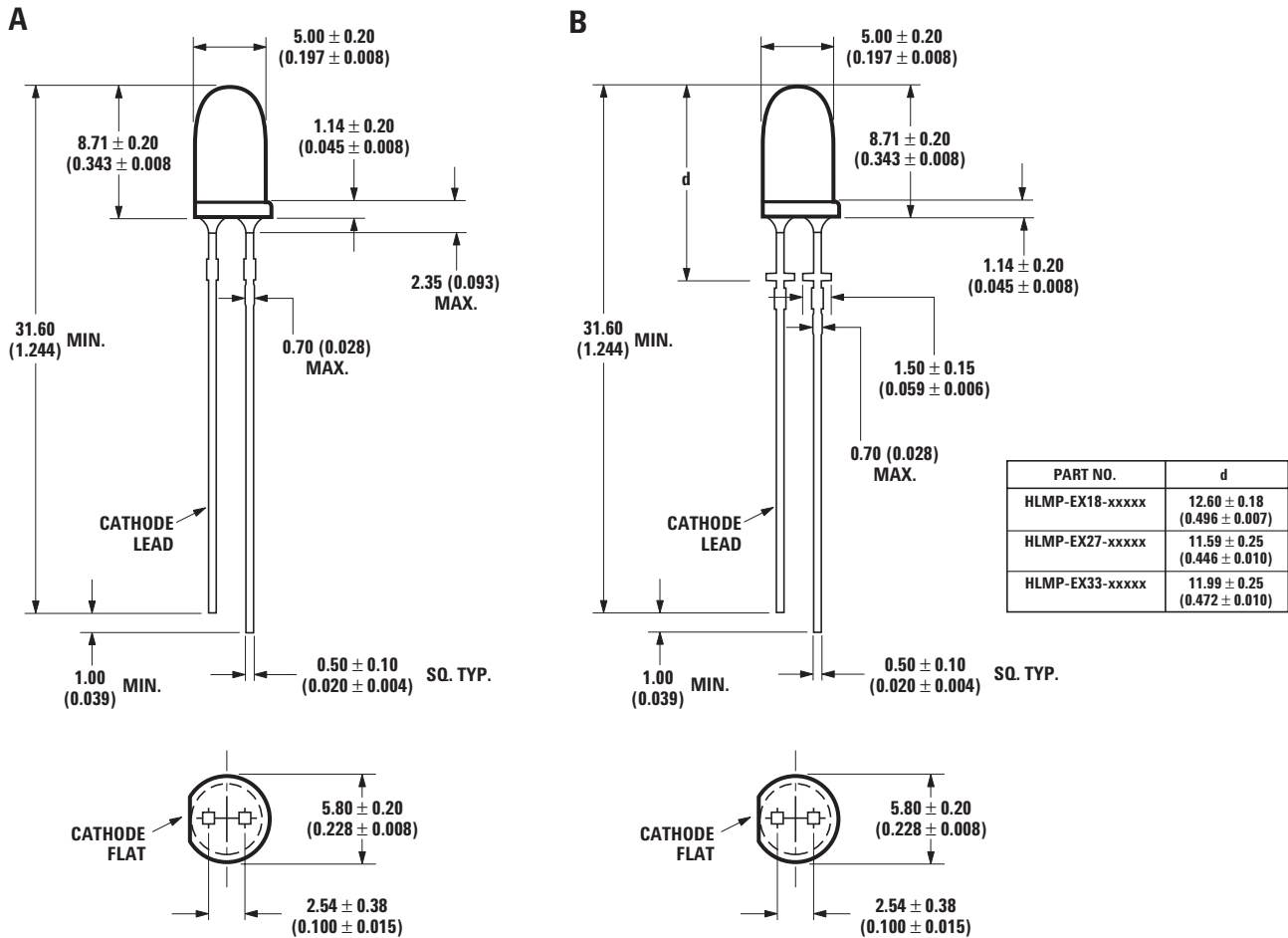

## Absolute Maximum Ratings at $T_A = 25^\circ\text{C}$

DC Forward Current <sup>[1,2,3]</sup> .....	50 mA
Peak Pulsed Forward Current <sup>[2,3]</sup> .....	100 mA
Average Forward Current .....	30 mA
Reverse Voltage ( $I_R = 100 \mu\text{A}$ ) .....	5 V
LED Junction Temperature .....	130°C
Operating Temperature .....	-40°C to +100°C
Storage Temperature .....	-40°C to +120°C
Wave Solder Temperature .....	250°C for 3 seconds
	[ 1.59 mm (0.060 in.) below body]

### Notes:

- Derate linearly as shown in Figure 4.
- For long term performance with minimal light output degradation, drive currents between 10 mA and 30 mA are recommended. For more information on recommended drive conditions, please refer to Application Brief I-024 (5966-3087E).
- Please contact your sales representative about operating currents below 10 mA.

[查询"HLMP-ED18-PX400"供应商](#)

### Electrical/Optical Characteristics at $T_A = 25^\circ\text{C}$

Parameter	Symbol	Min.	Typ.	Max.	Units	Test Conditions
Forward Voltage Amber ( $\lambda_d = 592 \text{ nm}$ ) Red-Orange ( $\lambda_d = 617 \text{ nm}$ ) Red ( $\lambda_d = 630 \text{ nm}$ )	$V_F$		2.15 2.08 2.00	2.4 <sup>[1]</sup>	V	$I_F = 20 \text{ mA}$
Reverse Voltage	$V_R$	5	20		V	$I_R = 100 \mu\text{A}$
Peak Wavelength Amber Red-Orange Red	$\lambda_{\text{PEAK}}$		594 623 639		nm	Peak of Wavelength of Spectral Distribution at $I_F = 20 \text{ mA}$
Spectral Halfwidth	$\Delta\lambda_{1/2}$		17		nm	Wavelength Width at Spectral Distribution $1/2$ Power Point at $I_F = 20 \text{ mA}$
Speed of Response	$\tau_s$		20		ns	Exponential Time Constant, $e^{-t/\tau_s}$
Capacitance	C		40		pF	$V_F = 0, f = 1 \text{ MHz}$
Thermal Resistance	$R_{\Theta\text{J-PIN}}$		240		$^\circ\text{C/W}$	LED Junction-to-Cathode Lead
Luminous Efficacy <sup>[2]</sup> Amber Red-Orange Red	$\eta_v$		500 235 155		lm/W	Emitted Luminous Power/Emitted Radiant Power at $I_F = 20 \text{ mA}$

#### Notes:

- For options -xxRxx, -xxSxx, -xxTxx, -xxUxx, -xxWxx, -xxYxx, max forward voltage (Vf) is 2.6 V. Refer to Vf bin table.
- The radiant intensity,  $I_e$ , in watts per steradian, may be found from the equation  $I_e = I_v/\eta_v$ , where  $I_v$  is the luminous intensity in candelas and  $\eta_v$  is the luminous efficacy in lumens/watt.

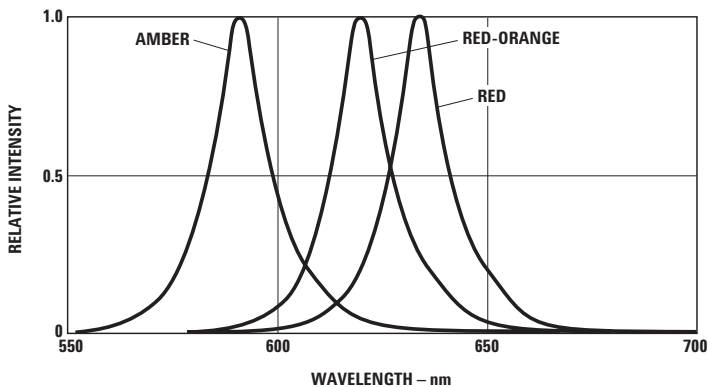

Figure 1. Relative Intensity vs. Peak Wavelength.

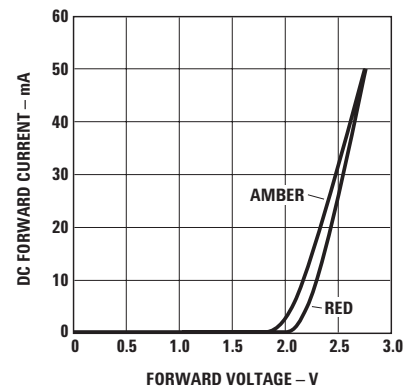

Figure 2a. Forward Current vs. Forward Voltage for Option -xxRxx, -xxSxx, -xxTxx, -xxUxx, and -xxVxx.



[查询"HLMP-ED18-PX400"供应商](#)

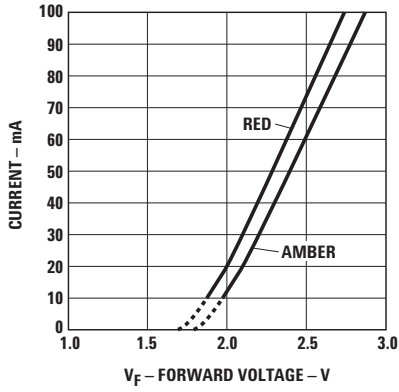

Figure 2b. Forward Current vs. Forward Voltage.

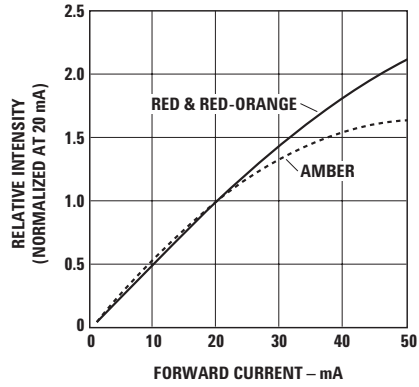

Figure 3. Relative Luminous Intensity vs. Forward Current.

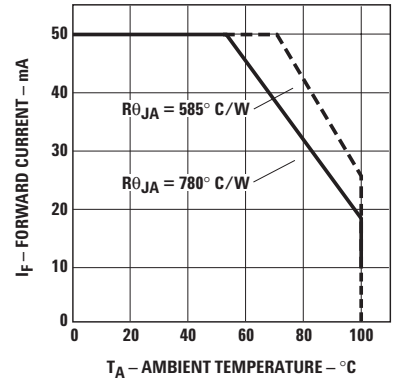

Figure 4. Maximum Forward Current vs. Ambient Temperature. Derating Based on  $T_{JMAX} = 130^{\circ}C$ .

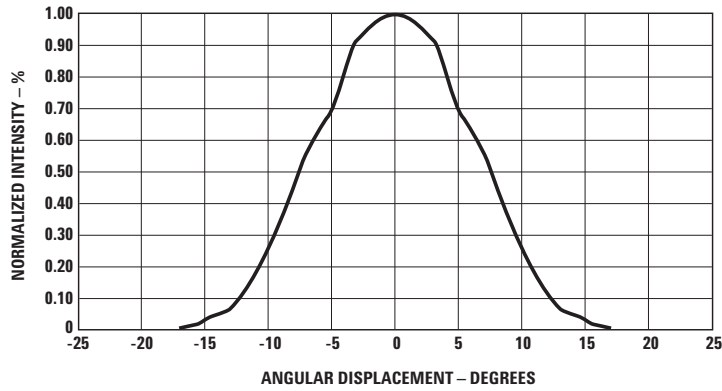

Figure 5. Representative Spatial Radiation Pattern for 15° Viewing Angle Lamps.

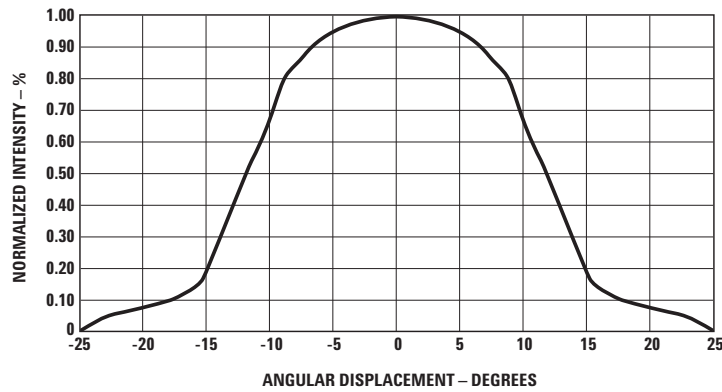

Figure 6. Representative Spatial Radiation Pattern for 24° Viewing Angle Lamps.

[查询"HLMP-ED18-PX400"供应商](#)

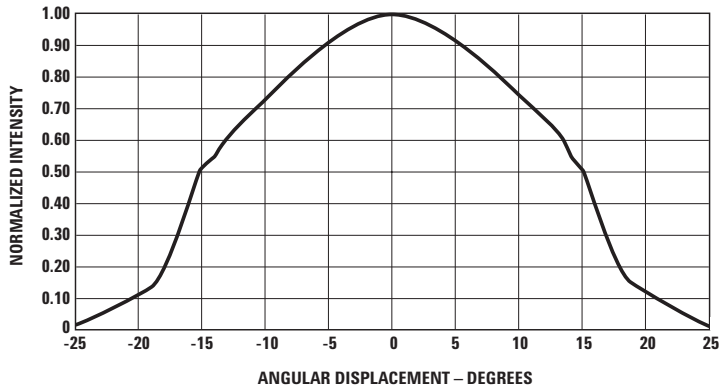

Figure 7. Representative Spatial Radiation Pattern for 30° Viewing Angle Lamps.

**Intensity Bin Limits  
(mcd at 20 mA)**

Bin Name	Min.	Max.
P	880	1150
Q	1150	1500
R	1500	1900
S	1900	2500
T	2500	3200
U	3200	4200
V	4200	5500
W	5500	7200
X	7200	9300
Y	9300	12000
Z	12000	16000

Tolerance for each bin limit is  $\pm 15\%$ .

**Amber Color Bin Limits  
(nm at 20 mA)**

Bin Name	Min.	Max.
1	584.5	587.0
2	587.0	589.5
4	589.5	592.0
6	592.0	594.5

Tolerance for each bin limit is  $\pm 0.5$  nm.

**Note:**

1. Bin categories are established for classification of products. Products may not be available in all bin categories.
2. Vf Bin table only available for those part number with options -xxRxx, -xxSxx, -xxTxx, -xxUxx, -xxWxx, -xxYxx.

**Vf Bin Table<sup>[2]</sup>**

Bin Name	Min.	Max.
VA	2.0	2.2
VB	2.2	2.4
VC	2.4	2.6

Tolerance for each bin limit is  $\pm 0.05$  V.

[查询"HLMP-ED18-PX400"供应商](#)



**[www.agilent.com/semiconductors](http://www.agilent.com/semiconductors)**

For product information and a complete list of distributors, please go to our web site.

For technical assistance call:

Americas/Canada: +1 (800) 235-0312 or  
(916) 788-6763

Europe: +49 (0) 6441 92460

China: 10800 650 0017

Hong Kong: (+65) 6756 2394

India, Australia, New Zealand: (+65) 6755 1939

Japan: (+81 3) 3335-8152 (Domestic/International), or 0120-61-1280 (Domestic Only)

Korea: (+65) 6755 1989

Singapore, Malaysia, Vietnam, Thailand,  
Philippines, Indonesia: (+65) 6755 2044

Taiwan: (+65) 6755 1843

Data subject to change.

Copyright © 2004 Agilent Technologies, Inc.

Obsoletes 5988-8601EN

June 23, 2004

5989-0661EN