

Triple-Balanced Mixer

MY87/MY87C

V2

Features

- LO 0.5 TO 19 GHz
- RF 0.5 TO 19 GHz
- IF 0.03 TO 5 GHz
- LO DRIVE +13 dBm (nominal)
- VERY WIDE BANDWIDTH

Description

MY87 is a triple balanced mixer, designed for use in military, commercial and test equipment applications. The design utilizes Schottky ring quad diodes and broadband soft dielectric baluns to attain excellent performance. The use of high temperature solder assembly processes used internally makes it ideal for use in manual, semi-automated assembly. Environmental screening available to MIL-STD-883, MIL-STD-202 or MIL-DTL-28837, consult factory.

Product Image

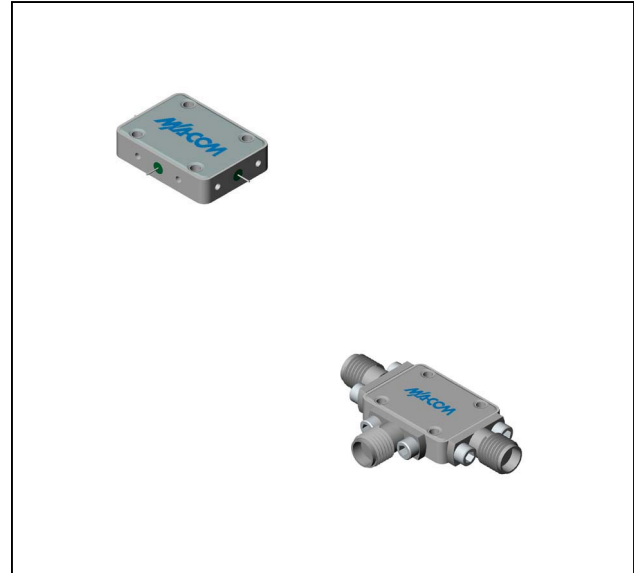

Ordering Information

Part Number	Package
MY87	Versapac
MY87C	SMA Connectorized

Electrical Specifications: $Z_0 = 50\Omega$ $Lo = +13$ dBm (Downconverter Application only)

Parameter	Test Conditions	Units	Typical	Guaranteed	
				+25°C	-54° to +85°C
SSB Conversion Loss (max) & SSB Noise Figure (max)	fR = 1 to 18 GHz, fL = 0.5 to 18 GHz, fl = 0.03 to 3 GHz	dB	7.5	10.5	11.0
	fR = 0.5 to 18 GHz, fL = 0.5 to 18 GHz, fl = 0.03 to 4 GHz	dB	8.5	11.0	11.5
	fR = 0.7 to 19 GHz, fL = 3 to 19 GHz, fl = 0.03 to 5 GHz	dB	10.5	12.0	12.5
Isolation, L to R (min)	fL = 0.5 to 3 GHz	dB	17	10	8
	fL = 3 to 19 GHz	dB	30	20	18
Isolation, L to I (min)	fL = 0.5 to 5 GHz	dB	32	22	20
1 dB Conversion Comp.	fL = +13 dBm	dBm	+8		
Input IP3	fR1 = 5 GHz at -6 dBm, fR2 = 6.01 GHz at -6 dBm, fL = 7 GHz at +13 dBm	dBm	+16.5		
	fR1 = 15 GHz at -6 dBm, fR2 = 15.01 GHz at -6 dBm, fL = 18 GHz at +13 dBm	dBm	+18		

Typical Performance Curves

Conversion Loss vs. LO Drive Power

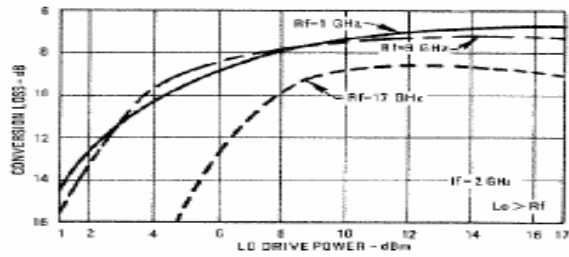

R-Port VSWR vs. Frequency

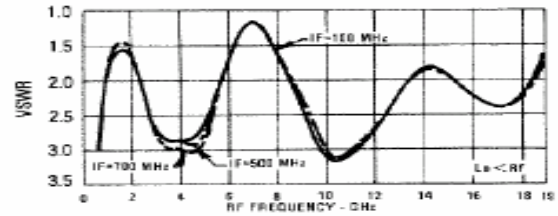

Conversion Loss vs. Frequency LO @ +13 dBm

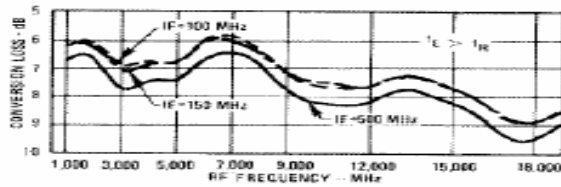

R-Port VSWR vs. Frequency

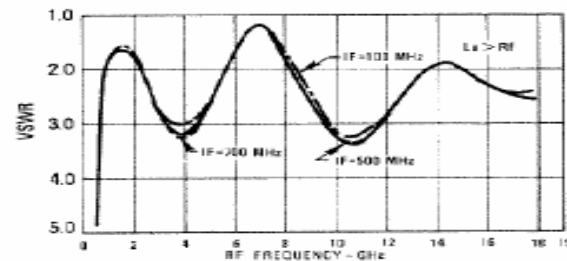
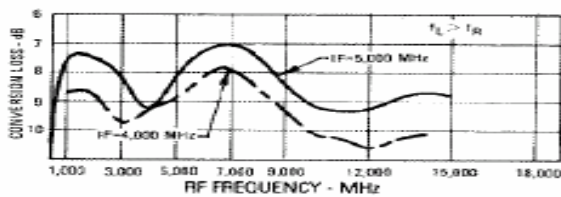
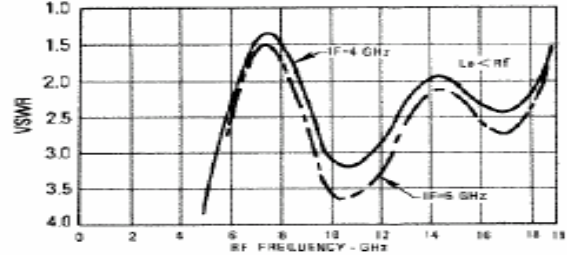

Isolation vs. Frequency

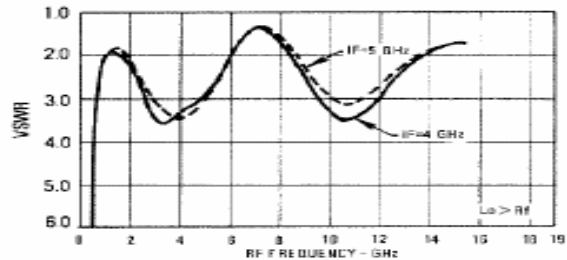
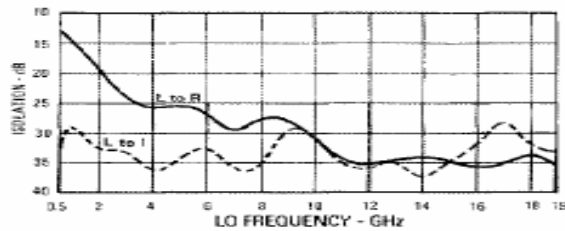

Absolute Maximum Ratings

Parameter	Absolute Maximum
Operating Temperature	-54°C to +100°C
Storage Temperature	-65°C to +100°C
Peak Input Power	+26 dBm max @ +25°C +23 dBm max @ +100°C
Peak Input Current	100 mA DC

L-PORT VSWR vs. Frequency

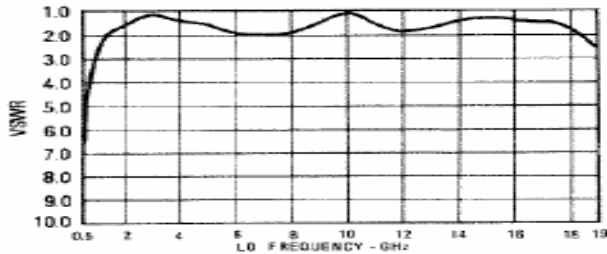

I-Port VSWR vs. Frequency

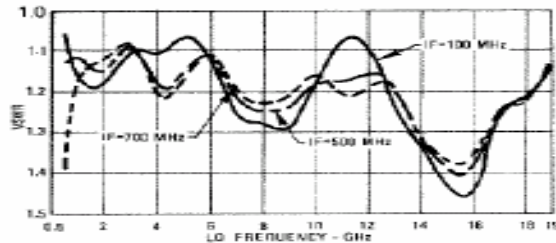

I-Port VSWR vs. Frequency

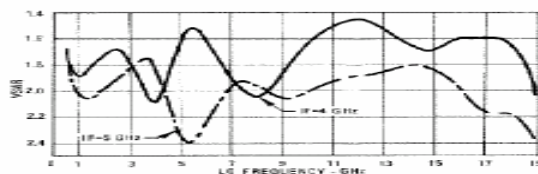
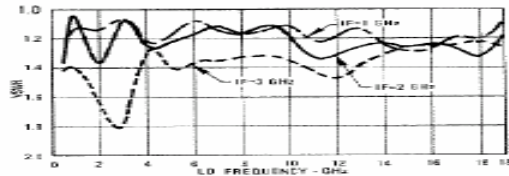

Outline Drawing: Versapac *

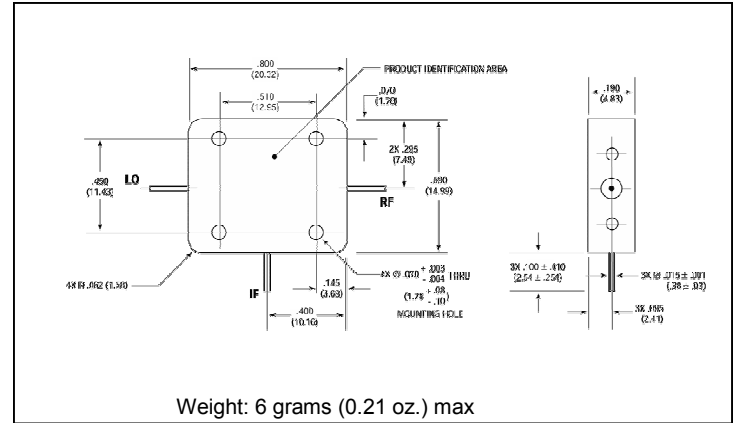

Outline Drawing: SMA Connectorized *

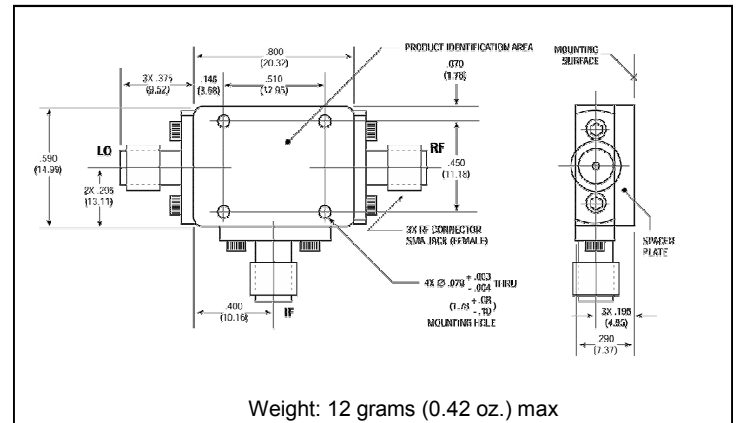

* Dimensions are inches (millimeters) ±0.015 (0.38) unless otherwise specified.