

查询"74HC573D.T"供应商

OCTAL D-TYPE TRANSPARENT LATCH; 3-STATE

FEATURES

- Inputs and outputs on opposite sides of package allowing easy interface with microprocessors
- Useful as input or output port for microprocessors/microcomputers
- 3-state non-inverting outputs for bus oriented applications
- Common 3-state output enable input
- Functionally identical to the "563" and "373"
- Output capability: bus driver
- I_{CC} category: MSI

GENERAL DESCRIPTION

The 74HC/HCT573 are high-speed Si-gate CMOS devices and are pin compatible with low power Schottky TTL (LS TTL). They are specified in compliance with JEDEC standard no. 7A.

The 74HC/HCT573 are octal D-type transparent latches featuring separate D-type inputs for each latch and 3-state outputs for bus oriented applications. A latch enable (LE) input and an output enable (\overline{OE}) input are common to all latches.

The "573" consists of eight D-type transparent latches with 3-state true outputs. When LE is HIGH, data at the D_n inputs enter the latches. In this condition the latches are transparent, i.e. a latch output will change state each time its corresponding D-input changes.

When LE is LOW the latches store the information that was present at the D-inputs a set-up time preceding the HIGH-to-LOW transition of LE.

When \overline{OE} is LOW, the contents of the 8 latches are available at the outputs.

When \overline{OE} is HIGH, the outputs go to the high impedance OFF-state. Operation of the \overline{OE} input does not affect the state of the latches.

(continued on next page)

SYMBOL	PARAMETER	CONDITIONS	TYPICAL		UNIT
			HC	HCT	
t _{PHL} / t _{PLH}	propagation delay D _n to Q _n LE to Q _n	C _L = 15 pF V _{CC} = 5 V	14 15	17 15	ns
C _I	input capacitance		3.5	3.5	pF
C _{PD}	power dissipation capacitance per latch	notes 1 and 2	26	26	pF

GND = 0 V; T_{amb} = 25 °C; t_r = t_f = 6 ns

Notes

1. C_{PD} is used to determine the dynamic power dissipation (P_D in μW):

$$P_D = C_{PD} \times V_{CC}^2 \times f_i + \sum (C_L \times V_{CC}^2 \times f_o) \text{ where:}$$

f_i = input frequency in MHz C_L = output load capacitance in pF

f_o = output frequency in MHz V_{CC} = supply voltage in V

∑ (C_L × V_{CC}² × f_o) = sum of outputs

2. For HC the condition is V_I = GND to V_{CC}
For HCT the condition is V_I = GND to V_{CC} - 1.5 V

PACKAGE OUTLINES

20-lead DIL; plastic (SOT146).
20-lead mini-pack; plastic (SO20; SOT163A).

PIN DESCRIPTION

PIN NO.	SYMBOL	NAME AND FUNCTION
2, 3, 4, 5, 6, 7, 8, 9	D ₀ to D ₇	data inputs
11	LE	latch enable input (active HIGH)
1	\overline{OE}	3-state output enable input (active LOW)
10	GND	ground (0 V)
19, 18, 17, 16, 15, 14, 13, 12	Q ₀ to Q ₇	3-state latch outputs
20	V _{CC}	positive supply voltage

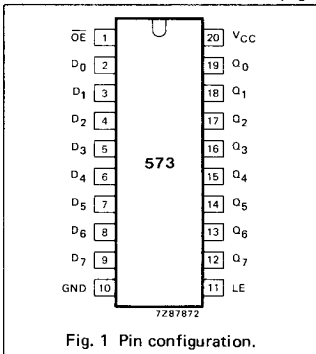

Fig. 1 Pin configuration.

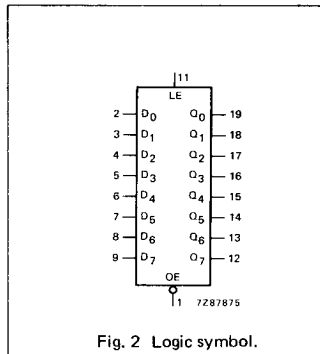

Fig. 2 Logic symbol.

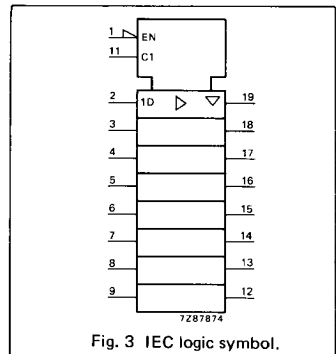

Fig. 3 IEC logic symbol.

查询"74HCT573D-T"供应商

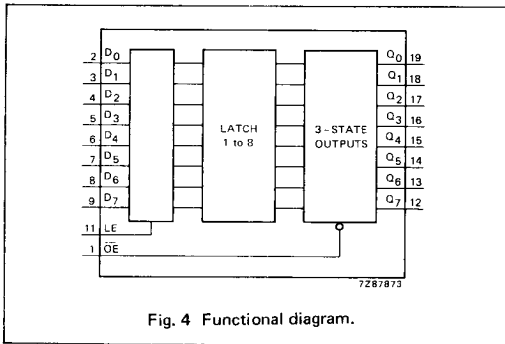

Fig. 4 Functional diagram.

GENERAL DESCRIPTION

The "573" is functionally identical to the "563" and "373", but the "563" has inverted outputs and the "373" has a different pin arrangement.

FUNCTION TABLE

OPERATING MODES	INPUTS			INTERNAL LATCHES	OUTPUTS Q ₀ to Q ₇
	\overline{OE}	LE	D _n		
enable and read register (transparent mode)	L L	H H	L H	L H	L H
latch and read register	L L	L L	l h	L H	L H
latch register and disable outputs	H H	L L	l h	L H	Z Z

H = HIGH voltage level
h = HIGH voltage level one set-up time
prior to the HIGH-to-LOW LE
transition

L = LOW voltage level
l = LOW voltage level one set-up time
prior to the HIGH-to-LOW LE
transition

Z = high impedance OFF-state

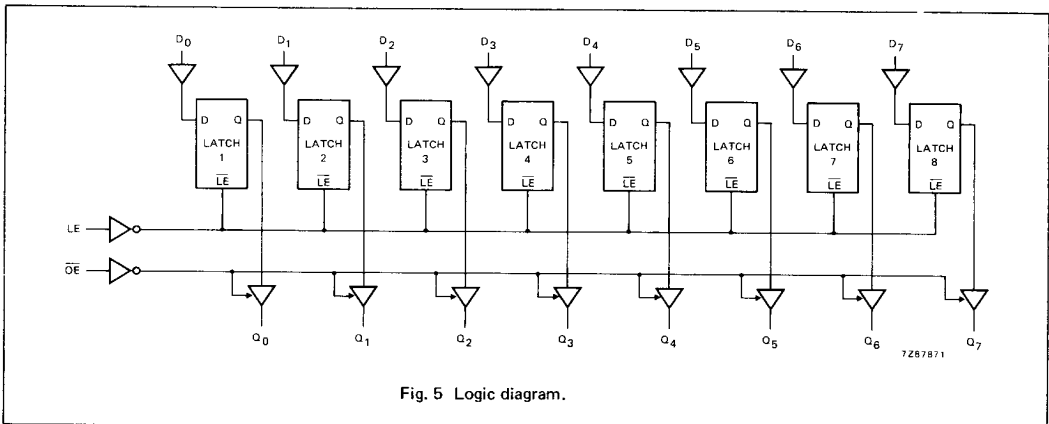

Fig. 5 Logic diagram.

[查询"74HCT573D-1"供应商](#)**DC CHARACTERISTICS FOR 74HC**

For the DC characteristics see chapter "HCMOS family characteristics", section "Family specifications".

Output capability: bus driver

I_{CC} category: MSI**AC CHARACTERISTICS FOR 74HC**GND = 0 V; t_r = t_f = 6 ns; C_L = 50 pF

SYMBOL	PARAMETER	T _{amb} (°C)						UNIT	TEST CONDITIONS		
		74HC							V _{CC} V	WAVEFORMS	
		+25			-40 to +85		-40 to +125				
		min.	typ.	max.	min.	max.	min.				max.
t _{PHL} / t _{PLH}	propagation delay D _n to Q _n		47 17 14	150 30 26		190 38 33		225 45 38	ns	2.0 4.5 6.0	Fig. 6
t _{pHL} / t _{pLH}	propagation delay LE to Q _n		50 18 14	150 30 26		190 38 33		225 45 38	ns	2.0 4.5 6.0	Fig. 7
t _{pZH} / t _{pZL}	3-state output enable time OE to Q _n		44 16 13	140 28 24		175 35 30		210 42 36	ns	2.0 4.5 6.0	Fig. 8
t _{pHZ} / t _{pLZ}	3-state output disable time OE to Q _n		55 20 16	150 30 26		190 38 33		225 45 38	ns	2.0 4.5 6.0	Fig. 8
t _{THL} / t _{TLH}	output transition time		14 5 4	60 12 10		75 15 13		90 18 15	ns	2.0 4.5 6.0	Fig. 6
t _w	enable pulse width HIGH	80 16 14	14 5 4		100 20 17		120 24 20		ns	2.0 4.5 6.0	Fig. 7
t _{su}	set-up time D _n to LE	50 10 9	11 4 3		65 13 11		75 15 13		ns	2.0 4.5 6.0	Fig. 9
t _h	hold time D _n to LE	5 5 5	3 1 1		5 5 5		5 5 5		ns	2.0 4.5 6.0	Fig. 9

[查询"74HCT573D-T"供应商](#)

DC CHARACTERISTICS FOR 74HCT

For the DC characteristics see chapter "HCMOS family characteristics", section "Family specifications".

Output capability: bus driver

I_{CC} category: MSI

Note to HCT types

The value of additional quiescent supply current (ΔI_{CC}) for a unit load of 1 is given in the family specifications. To determine ΔI_{CC} per input, multiply this value by the unit load coefficient shown in the table below.

INPUT	UNIT LOAD COEFFICIENT
D _n	0.35
LE	0.65
OE	1.25

AC CHARACTERISTICS FOR 74HCT

GND = 0 V; t_r = t_f = 6 ns; C_L = 50 pF

SYMBOL	PARAMETER	T _{amb} (°C)						UNIT	TEST CONDITIONS		
		74HCT							V _{CC} V	WAVEFORMS	
		+25			-40 to +85		-40 to +125				
		min.	typ.	max.	min.	max.	min.				max.
t _{PHL} / t _{PLH}	propagation delay D _n to Q _n		20	35		44		53	ns	4.5	Fig. 6
t _{PHL} / t _{PLH}	propagation delay LE to Q _n		18	35		44		53	ns	4.5	Fig. 7
t _{PZH} / t _{PZL}	3-state output enable time OE to Q _n		17	30		38		45	ns	4.5	Fig. 8
t _{PHZ} / t _{PLZ}	3-state output disable time OE to Q _n		18	30		38		45	ns	4.5	Fig. 8
t _{THL} / t _{TLH}	output transition time		5	12		15		18	ns	4.5	Fig. 6
t _W	enable pulse width HIGH	16	5		20		24		ns	4.5	Fig. 7
t _{su}	set-up time D _n to LE	13	7		16		20		ns	4.5	Fig. 9
t _h	hold time D _n to LE	9	4		11		14		ns	4.5	Fig. 9

查询"74HCT573D-T"供应商

AC WAVEFORMS

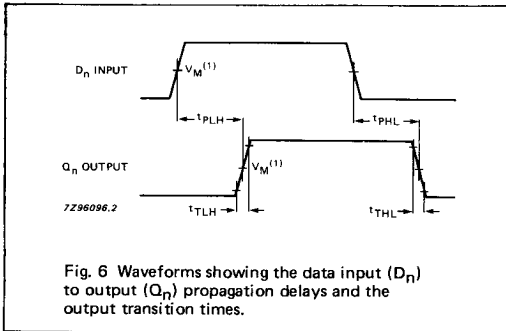

Fig. 6 Waveforms showing the data input (D_n) to output (Q_n) propagation delays and the output transition times.

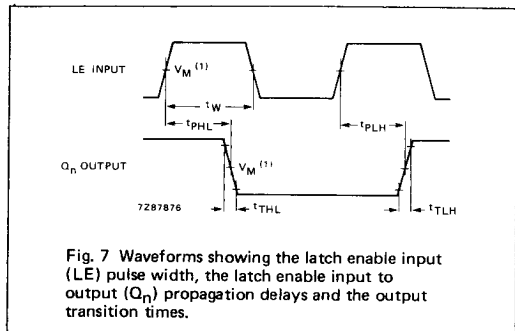

Fig. 7 Waveforms showing the latch enable input (LE) pulse width, the latch enable input to output (Q_n) propagation delays and the output transition times.

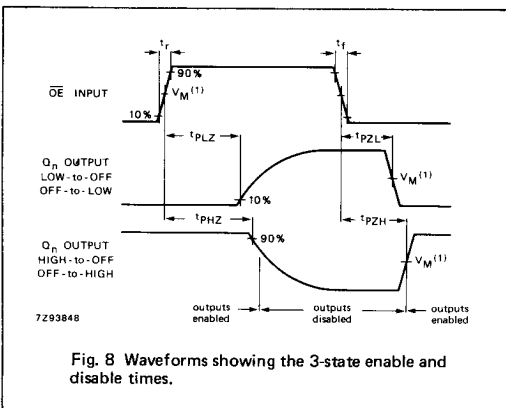

Fig. 8 Waveforms showing the 3-state enable and disable times.

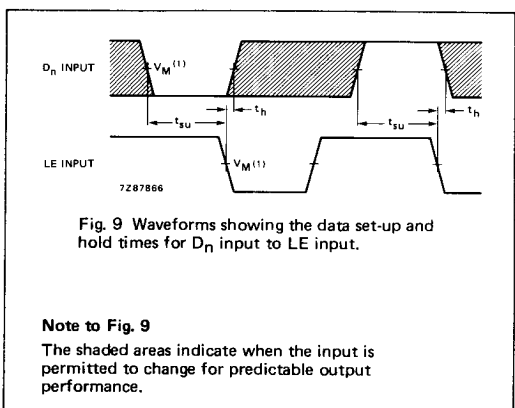

Fig. 9 Waveforms showing the data set-up and hold times for D_n input to LE input.

Note to Fig. 9

The shaded areas indicate when the input is permitted to change for predictable output performance.

Note to AC waveforms

- (1) HC : $V_M = 50\%$; $V_I = GND$ to V_{CC} .
- HCT: $V_M = 1.3V$; $V_I = GND$ to $3V$.