

查询"SML-LX1110UPGC-ATR"供应商

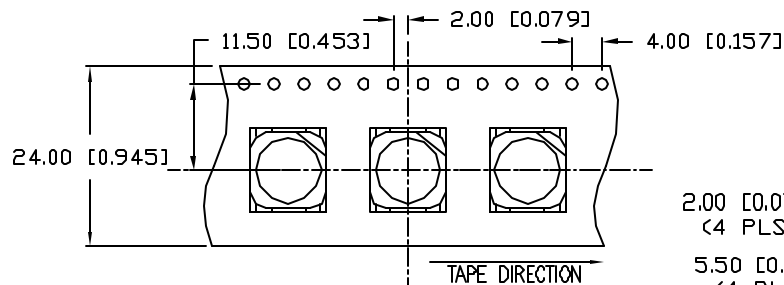

LEAD FREE REFLOW PROFILE

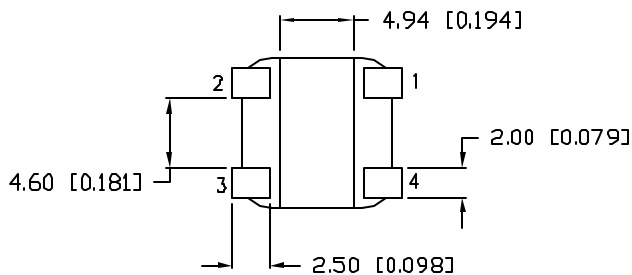
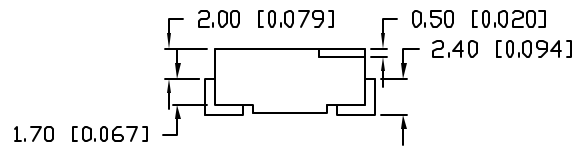
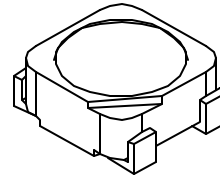
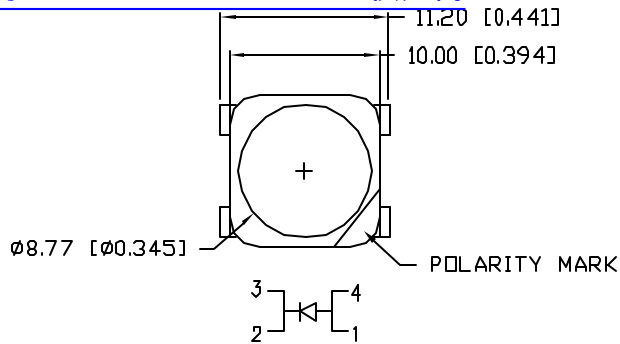
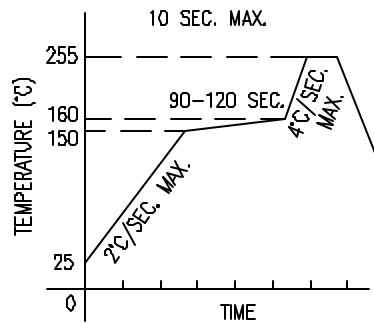

TOTAL TIME ABOVE 220°C IS 60 SECONDS MAX.

ELECTRO-OPTICAL CHARACTERISTICS  $T_A=25^\circ\text{C}$   $I_f=350\text{mA}$

PARAMETER	MIN	TYP	MAX	UNITS	TEST COND
PEAK WAVELENGTH		525		nm	
FORWARD VOLTAGE		3.5	4.0	$V_f$	
REVERSE VOLTAGE	5.0			$V_r$	$I_r=100\mu\text{A}$
AXIAL INTENSITY		10000		mcad	$I_f=350\text{mA}$
LUMINOUS FLUX		20		lm	$I_f=350\text{mA}$
VIEWING ANGLE		90		2x theta	
EMITTED COLOR:	GREEN				
EPOXY LENS FINISH:	WATER CLEAR				

LIMITS OF SAFE OPERATION AT 25°C

PARAMETER	MAX	UNITS
PEAK FORWARD CURRENT*	500	mA
STEADY CURRENT	350	mA
POWER DISSIPATION	120	mW
DERATE FROM 25°C	-1.2	mW/°C
OPERATING TEMP.	-40 TO +85	°C
STORAGE TEMP.	-40 TO +85	°C

CAUTION: STATIC SENSITIVE DEVICE  
FOLLOW PROPER E.S.D. HANDLING PROCEDURES  
WHEN WORKING WITH THIS PART.

RECOMMENDED SOLDER PAD LAYOUT

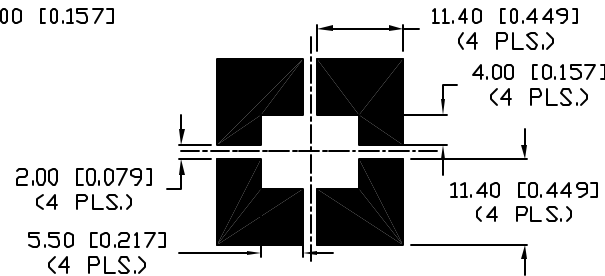

NOTES:

1. ANODE TOWARDS TAPE HOLE.



\*UNLESS OTHERWISE SPECIFIED TOLERANCES PER DECIMAL PRECISION ARE: X=±1 (±0.039), X.X=±0.5 (±0.020), X.XX=±0.25 (±0.010), X.XXX=±0.127 (±0.005). LEAD SIZE=±0.05 (±0.002), LEAD LENGTH=±0.75 (±0.030), MIN=+0.00 DECIMAL PRECISION MAX.=+0.00 DECIMAL PRECISION

UNCONTROLLED DOCUMENT

REV.

PART NUMBER

SML-LX1110UPGC-ATR

PLCC-4 SMT LED, HIGH POWER, 525nm ULTRA PURE GREEN,  
WITH INTERNAL REFLECTIVE CAVITY.

CONFIDENTIAL INFORMATION

THE INFORMATION CONTAINED IN THIS DOCUMENT IS THE PROPERTY OF LUMEX INC. EXCEPT AS SPECIFICALLY AUTHORIZED IN WRITING BY LUMEX INC, THE HOLDER OF THIS DOCUMENT SHALL KEEP ALL INFORMATION CONTAINED HEREIN CONFIDENTIAL AND SHALL PROTECT SAME IN WHOLE OR IN PART FROM DISCLOSURE AND DISSEMINATION TO ALL THIRD PARTIES.

RELIABILITY NOTE

OUR MANY YEARS OF EXPERIENCE DATA ACCUMULATION INDICATE THAT SOLDER HEAT IS A MAJOR CAUSE OF EARLY AND FUTURE FAILURE. PLEASE PAY ATTENTION TO YOUR SOLDERING PROCESS.



290 E. HELEN ROAD  
PALATINE, IL 60067-6976  
PHONE: +1.847.359.2790  
US WEB: www.lumex.com  
TW WEB: www.lumex.com.tw

DRAWN BY:

CHECKED BY:

APPROVED BY:

DATE: 7.11.05

JD

PAGE: 1 OF 1

SCALE: N/A