

LP3994

50mA CMOS Voltage Regulator with Enable Control

General Description

The LP3994 regulator provides 1.5V and 1.8V outputs options at up to 50mA load current. The LP3994 provides an accurate output voltage with low quiescent current at full current. Good noise performance is obtained without a noise bypass capacitor. The low quiescent current in operation can be reduced to virtually zero when the device is disabled via a logic signal to the enable input. In conjunction with small space saving capacitors, the small package size of the microSMD devices results in a regulator solution with a very small footprint for any given application.

The LP3994 is suitable for general use within the range of portable, battery-powered equipment and voltage options other than 1.5V and 1.8V can be made available.

The LP3994 also features short-circuit and thermal-shutdown protection.

Performance is specified for a -40°C to 125°C temperature range.

This device is available with output voltages of 1.5V and 1.8V in both microSMD and LLP packages. Other voltages and alternative packages may be made available, please contact your local NSC sales office.

Features

- 4 Pin MicroSMD Package/ 6 Pin LLP
- No Noise Bypass Capacitor Required
- Logic Controlled Enable
- Stable with Low ESR Ceramic Capacitors
- Fast turn on time
- Thermal-Overload and Short Circuit Protection

Key Specifications

| | |
|--|---------------------------|
| ■ Input Voltage Range | 2.5 to 5.5V |
| ■ Output Voltage Range | 1.5 to 3.3V |
| ■ Output Current | 50mA |
| ■ Noise Figure | 95 μ V _{RMS} |
| ■ PSRR | 70dB |
| ■ Fast Startup | 10 μ s |
| ■ Output Capacitor | 1 μ F Low ESR |
| ■ Virtually Zero I _Q (Disabled) | 0.001 μ A |

Package

| | |
|----------------------|---------------------|
| Tiny 4 Pin micro SMD | 1mm by 1mm by 0.6mm |
| 6 pin LLP | SOT23 footprint |

Applications

- Bluetooth Devices
- Battery Powered Devices
- Portable Information Appliances

Typical Application Circuit

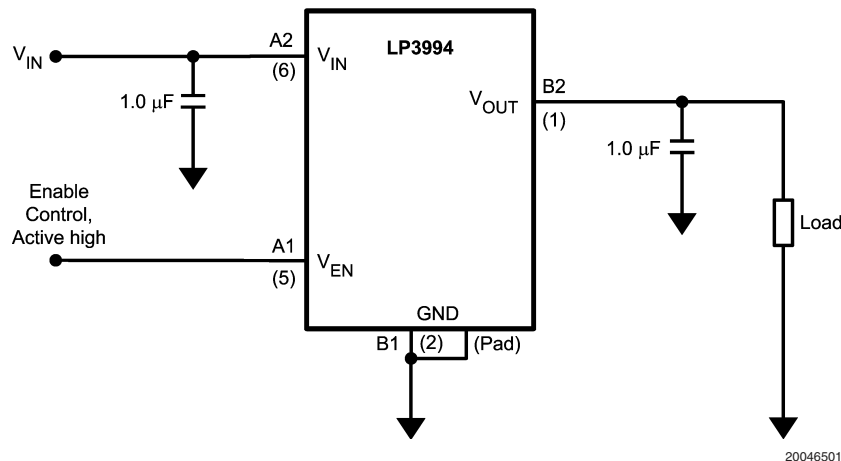

Packages micro SMD-4 and LLP-6

| Pin No micro SMD | Pin No LLP | Symbol | Name and Function |
|------------------------|---------------|-----------|--|
| A1 | 5 | V_{EN} | Enable Input; Enables the Regulator when $\geq 1.2V$ Disables the Regulator when $\leq 0.4V$ |
| B1 | 2 | GND | Common Ground |
| B2 | 1 | V_{OUT} | Voltage output. A $1.0\mu F$ Low ESR Capacitor should be connected to this Pin. Connect this output to the load circuit. |
| A2 | 6 | V_{IN} | Voltage Supply Input. A $1.0\mu F$ capacitor should be connected at this input. |
| | 3 | | No Connection. Do not connect to any other device pins. |
| | 4 | | No Connection. Do not connect to any other device pins. |
| | pad | | Connect to ground for good thermal operation. |

Connection Diagrams

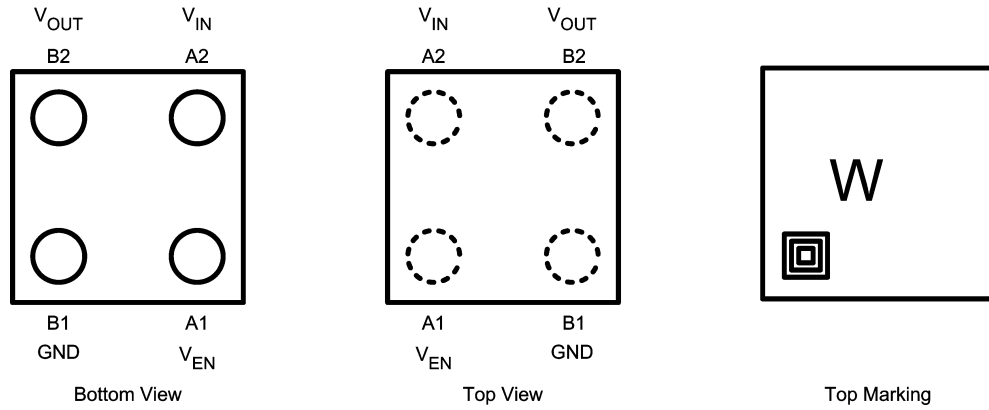

20046502

micro SMD-4 Package
 See NS package number TLA04

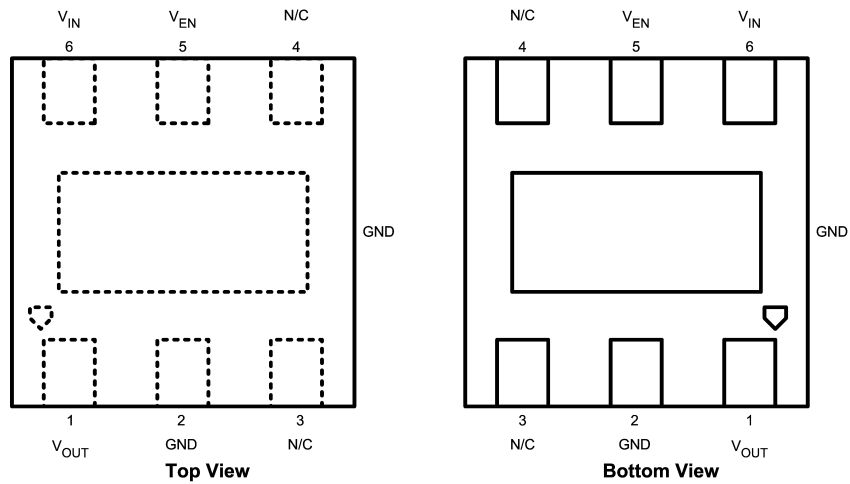

20046507

LLP- 6 Package (SOT23 footprint)
 See NS Package Number LDE06A

Ordering Information[查询"LP3994LD-1.8"供应商](#)

For micro SMD Package

| Output Voltage (V) | Grade | LP3994 Supplied as 1000 Units, Tape and Reel | LP3994 Supplied as 3000 Units, Tape and Reel | |
|--------------------|-------|--|--|--|
| 1.5 | STD | LP3994TL-1.5 | LP3994TLX-1.5 | |
| 1.8 | STD | LP3994TL-1.8 | LP3994TLX-1.8 | |

For microSMD Package (Lead Free)

| Output Voltage (V) | Grade | LP3994 Supplied as 1000 Units, Tape and Reel | LP3994 Supplied as 3000 Units, Tape and Reel | |
|--------------------|-------|--|--|--|
| 1.5 | STD | LP3994TL-1.5NOPB | LP3994TLX-1.5NOPB | |
| 1.8 | STD | LP3994TL-1.8NOPB | LP3994TLX-1.8NOPB | |

For LLP Package

| Output Voltage (V) | Grade | LP3994 Supplied as 1000 Units, Tape and Reel | LP3994 Supplied as 3000 Units, Tape and Reel | Package Marking |
|--------------------|-------|--|--|-----------------|
| 1.5 | STD | LP3994LD-1.5 | LP3994LDX-1.5 | L028B |
| 1.8 | STD | LP3994LD-1.8 | LP3994LDX-1.8 | L029B |

Absolute Maximum Ratings

(Notes 1, 2)
[询价"LR3994LD-1.8"供应商](#)

If Military/Aerospace specified devices are required, please contact the National Semiconductor Sales Office/Distributors for availability and specifications.

| | |
|---------------------------------------|--|
| Input Voltage | -0.3 to 6.5V |
| Output Voltage | -0.3 to (V _{IN} + 0.3V) to 6.5V (max) |
| Enable Input Voltage | -0.3 to (V _{IN} + 0.3V) to 6.5V (max) |
| Junction Temperature | 150°C |
| Lead Temp. | |
| | microSMD 260°C |
| | LLP 235°C |
| Storage Temperature | -65 to 150°C |
| Continuous Power Dissipation(Notes 3) | Internally Limited |

ESD Rating (Note 4)

| | |
|------------------|------|
| Human Body Model | 2KV |
| Machine Model | 200V |

Operating Conditions(Notes 1, 2)

| | |
|--|-------------------------------|
| Input Voltage | 2.5 to 5.5V |
| Enable Input Voltage | 0 to (V _{IN} + 0.3V) |
| Junction Temperature (T _J) Range | -40°C to 125°C |
| Ambient Temperature (T _A) Range (Note 5) | -40 to 85°C |

Thermal Properties

Junction to Ambient Thermal Resistance(Note 6)

| | |
|----------------------------------|---------|
| θ _{JA} microSMD package | 220°C/W |
| θ _{JA} LLP package | 88°C/W |

Electrical Characteristics(Notes 2, 7)

Unless otherwise noted, V_{EN} = 1.2, V_{IN} = V_{OUT} + 1.0V, C_{IN} = 1 μF, I_{OUT} = 1 mA, C_{OUT} = 1 μF. Typical values and limits appearing in normal type apply for T_J = 25°C. Limits appearing in **boldface** type apply over the full temperature range for operation, -40 to +125°C. (Notes 13, 14)

| Symbol | Parameter | Conditions | Min | Typ | Max | Units |
|---|------------------------------------|--|-------------------------|-----------|--------------------------|-------|
| Device Output: V_{OUT} ≤ 1.8V | | | | | | |
| V _{IN} | Input Voltage | | 2.5 | | 5.5 | V |
| ΔV _{OUT} | Output Voltage Tolerance | Over full line and load regulation. | -60 | | +60 | mV |
| | Line Regulation Error | V _{IN} = (V _{OUT(NOM)} + 1.0V) to 5.5V, I _{OUT} = 1mA | | 0.005 | 0.07 | %/V |
| | Load Regulation Error | I _{OUT} = 1mA to 50mA | | 100 | 400 | μV/mA |
| I _Q | Quiescent Current | microSMD: | I _{OUT} = 0mA | 15 | 35 | μA |
| | | | I _{OUT} = 50mA | 22 | 50 | |
| | | LLP: | I _{OUT} = 0mA | 15 | 40 | |
| | | | I _{OUT} = 50mA | 25 | 65 | |
| | Quiescent Current(Disabled) | V _{EN} = 0.4V | | 0.001 | 1.5 | |
| Device Output: V_{OUT} > 1.8V | | | | | | |
| V _{IN} | Input Voltage | | 2.5 | | 5.5 | V |
| ΔV _{OUT} | Output Voltage Tolerance | Over full line and load regulation. | -90 | | +90 | mV |
| | Line Regulation Error | V _{IN} = (V _{OUT(NOM)} + 1.0V) to 5.5V, I _{OUT} = 1mA | | 0.005 | 0.1 | %/V |
| | Load Regulation Error | I _{OUT} = 1mA to 50mA | | 100 | 500 | μV/mA |
| | Dropout Voltage (where applicable) | I _{OUT} = 1mA I _{OUT} = 50mA | | 1.5 75 | 4.5 140 | mV |
| I _Q | Quiescent Current | microSMD: | I _{OUT} = 0mA | 18 | 50 | μA |
| | | | I _{OUT} = 50mA | 22 | 60 | |
| | | LLP: | I _{OUT} = 0mA | 20 | 55 | |
| | | | I _{OUT} = 50mA | 22 | 65 | |
| | Quiescent Current(Disabled) | V _{EN} = 0.4V | | 0.001 | 1.5 | |
| Full V_{OUT} RANGE | | | | | | |
| I _{LOAD} | Load Current | (Notes 8, 9) | 0 | | | μA |
| I _{SC} | Short Circuit Current Limit | (Note 12) | | | 235 | mA |

Electrical Characteristics (Notes 2, 7) (Continued)

Unless otherwise noted, $V_{IN} = V_{OUT} + 1.0V$, $C_{IN} = 1 \mu F$, $I_{OUT} = 1 mA$, $C_{OUT} = 1 \mu F$. Typical values and limits appearing in normal type apply for $T_J = 25^\circ C$. Limits appearing in **boldface** type apply over the full temperature range for operation, -40 to $+125^\circ C$. (Notes 13, 14)

| Symbol | Parameter | Conditions | Min | Typ | Max | Units |
|----------------|-------------------------------|---|-----|-----|-----|---------------|
| PSRR | Power Supply Rejection Ratio | $f = 100Hz$, $I_{OUT} = 1mA$ to $50mA$ | | 70 | | dB |
| | | $f = 50kHz$, $I_{OUT} = 1mA$ to $50mA$ | | 30 | | |
| | | $f = 1MHz$, $I_{OUT} = 1mA$ | | 50 | | |
| | | $f = 1MHz$, $I_{OUT} = 50mA$ | | 40 | | |
| E_n | Output noise Voltage (Note 9) | $BW = 100Hz$ to $100kHz$, $V_{IN} = 4.2V$, $I_{OUT} = 1mA$ | | 95 | | μV_{RMS} |
| $T_{SHUTDOWN}$ | Thermal Shutdown Temperature | | | 160 | | $^\circ C$ |
| | Thermal Shutdown Hysteresis | | | 20 | | |

Enable Control Characteristics

| | | | | | | |
|----------|---|-------------------------------------|------------|-------|------------|---------|
| I_{EN} | Maximum Input Current at V_{EN} Input | $V_{EN} = 0.0V$ and $V_{IN} = 5.5V$ | | 0.015 | | μA |
| V_{IL} | Low Input Threshold | $V_{IN} = 2.5V$ to $5.5V$ | | | 0.4 | V |
| V_{IH} | High Input Threshold | $V_{IN} = 2.5V$ to $5.5V$ | 1.2 | | | V |

Timing Characteristics

| | | | | | | |
|--------------------|--|---------------------------------------|--|----|-----|---------|
| T_{ON1} | Turn On Time (Note 9) | 10 to 90% of $V_{OUT(NOM)}$ (Note 10) | | 10 | 20 | μS |
| T_{ON2} | | To 95% Level (Note 11) | | 35 | 100 | |
| Transient Response | Line Transient Response $ \delta V_{OUT} $ | Figure 1 (Note 9) | | | 20 | mV |
| | Load Transient Response $ \delta V_{OUT} $ | Figure 2 (Note 9) | | | 70 | |

Note 1: Absolute Maximum Ratings are limits beyond which damage can occur. Operating Ratings are conditions under which operation of the device is guaranteed. Operating Ratings do not imply guaranteed performance limits. For guaranteed performance limits and associated test conditions, see the Electrical Characteristics tables.

Note 2: All Voltages are with respect to the potential at the GND pin.

Note 3: Internal thermal shutdown circuitry protects the device from permanent damage

Note 4: The human body is 100pF discharge through 1.5kW resistor into each pin. The machine model is a 200 pF capacitor discharged directly into each pin.

Note 5: In applications where high power dissipation and/or poor thermal resistance is present, the maximum ambient temperature may have to be derated. Maximum ambient temperature ($T_{A(max)}$) is dependant on the maximum operating junction temperature ($T_{J(max-op)}$), the maximum power dissipation ($P_{D(max)}$), and the junction to ambient thermal resistance in the application (θ_{JA}). This relationship is given by :-

$$T_{A(max)} = T_{J(max-op)} - (P_{D(max)} \times \theta_{JA})$$

See Applications section.

Note 6: Junction to ambient thermal resistance is highly application and board layout dependent. In applications where high maximum power dissipation exists, the thermal dissipation issues should be addressed in the board layout design.

Note 7: Min and Max limits are guaranteed by design, test, or statistical analysis. Typical numbers are not guaranteed, but do represent the most likely norm.

Note 8: The device maintains the regulated output voltage without the load.

Note 9: This electrical specification is guaranteed by design.

Note 10: Time for V_{OUT} to rise from 10 to 90% of $V_{OUT(nom)}$.

Note 11: Time from $V_{EN} = 1.2V$ to $V_{OUT} = 95\%(V_{OUT(nom)})$.

Note 12: Short circuit current is measured on the input supply line at the point when the short circuit condition reduces the output voltage to 95% of its nominal value.

Note 13: C_{IN} , and C_{OUT} : Low ESR surface mont devices used in setting electrical characteristics.

Note 14: All limits are guaranteed. All electrical characteristics having room-temperature limits are tested during production at $T_J = 25^\circ C$ or correlated using Statistical Quality Control methods. Operation over the temperature specification is guaranteed by correlating the electrical characteristics to process and temperature variations and applying statistical process control.

Output Capacitor, Recommended Specifications

| Symbol | Parameter | Conditions | Min | Typ | Max | Units |
|--------|------------------|----------------------|-----|-----|-----|------------|
| C_o | Output Capacitor | Capacitance(Note 15) | 0.7 | 1.0 | | μF |
| | | ESR | | 5 | 500 | m Ω |

Note 15: The capacitor tolerance should be $\pm 30\%$ or better over the full temperature range. The full range of operating conditions for the capacitor in the application should be considered during device selection to ensure this minimum capacitance specification is met. X7R capacitor types are recommended to meet the full device temperature range, however X5R, Y5V, and Z5U types may be used with careful consideration of the application and its operating conditions. (See Capacitor Sections in Application Hints.)

Transient Test Conditions

[查询"LP3994LD-1.8"供应商](#)

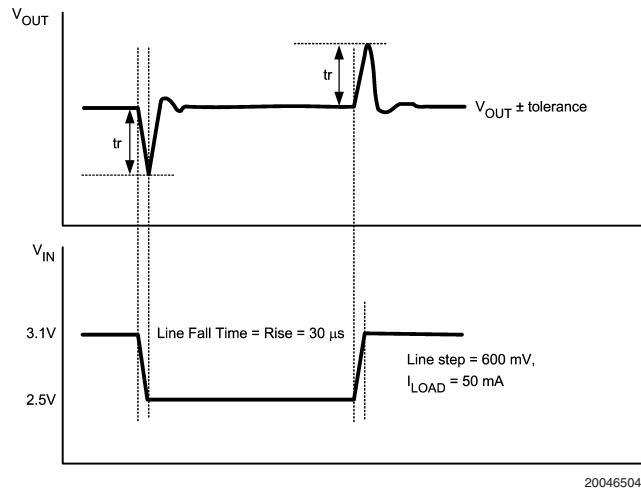

FIGURE 1. Line Transient Response Requirement.

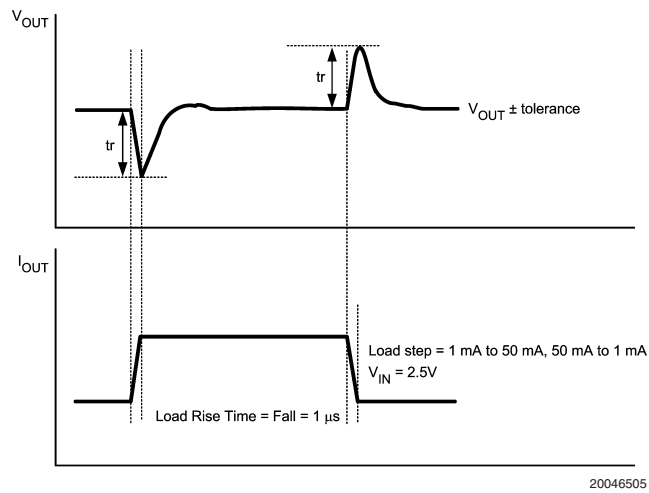

FIGURE 2. Load Transient Response Requirement.

Typical Performance Characteristics.

Unless otherwise specified, $C_{IN} = C_{OUT} = 1.0 \mu F$ Ceramic,

V_{IN} is tied to V_{IN} .

Output Voltage Change vs Temperature

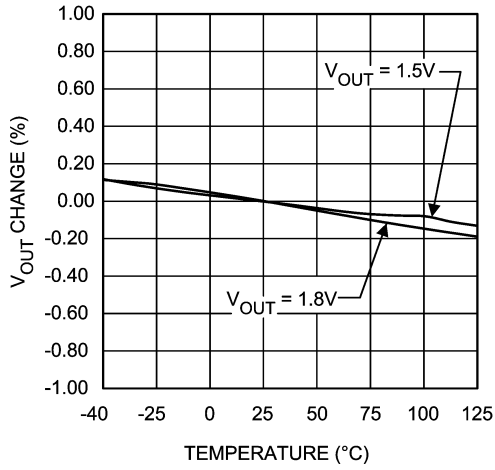

20046510

Ground Current vs Load Current

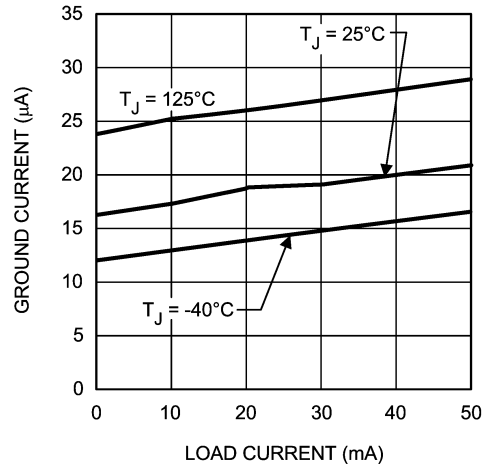

20046511

Ground Current vs V_{IN} , $I_{LOAD} = 1mA$

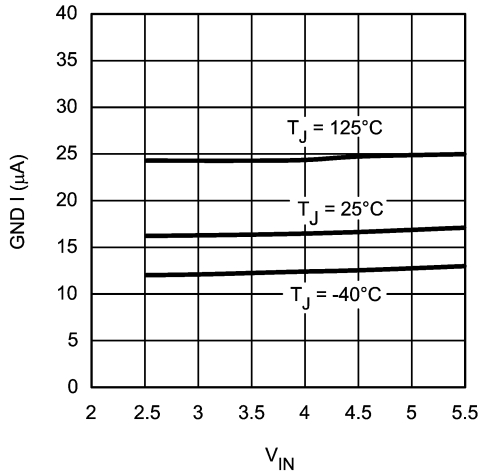

20046512

Short Circuit Current

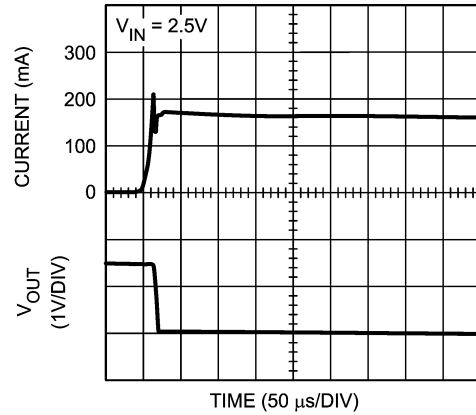

20046513

Line Transient Response

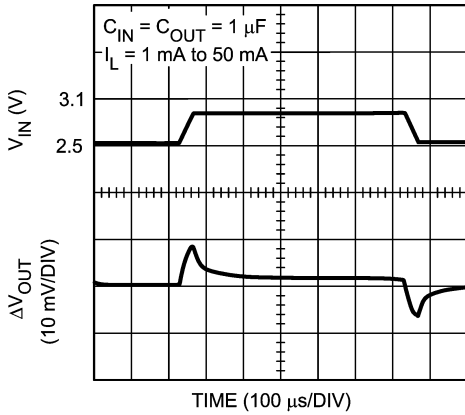

20046514

Load Transient Response

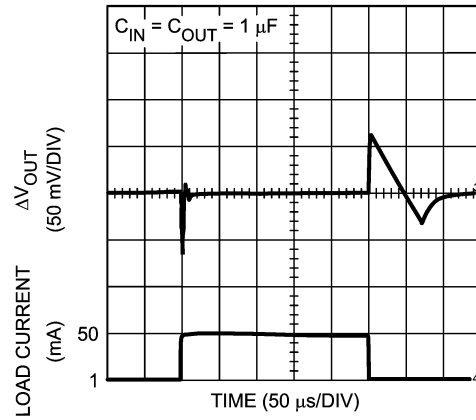

20046515

Typical Performance Characteristics. Unless otherwise specified, $C_{IN} = C_{OUT} = 1.0 \mu F$ Ceramic, V_{IN}

LP3394LDOV1.8" 供应商 V_{EN} pin is tied to V_{IN} . (Continued)

Enable Start Up Timing, ($V_{OUT} = 1.8V$)

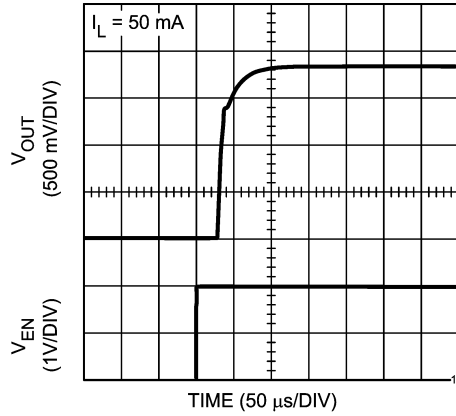

20046516

Enable Start Up Timing, ($V_{OUT} = 1.5V$)

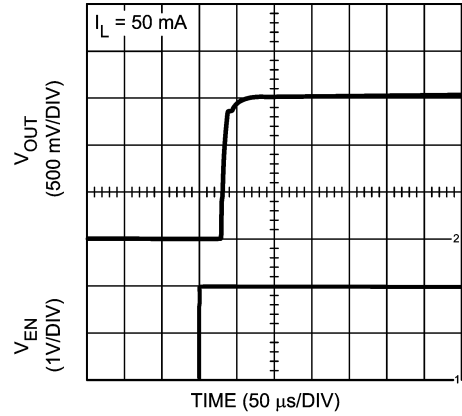

20046517

Ripple Rejection

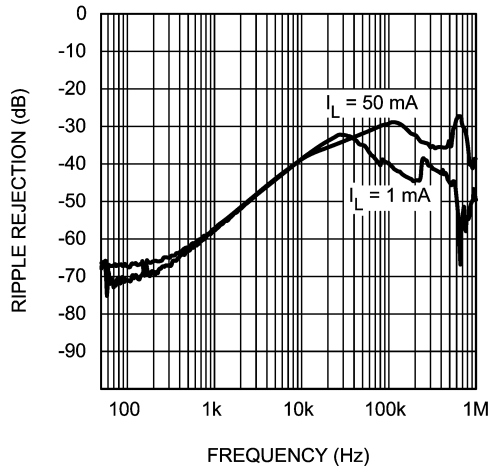

20046518

Noise Density ($V_{IN} = 4.2V$)

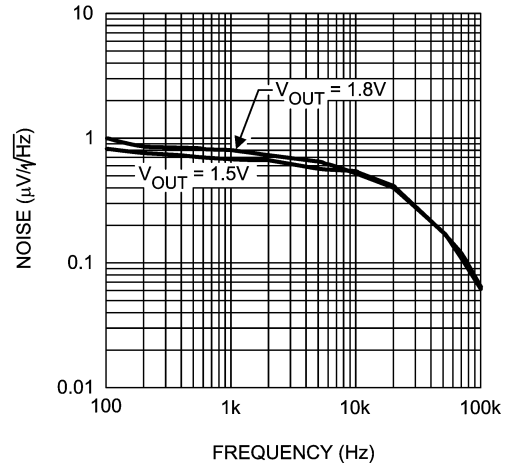

20046519

Application Hints

[查询"LP3994LD-1.8"供应商](#)

EXTERNAL CAPACITORS

In common with most regulators, the LP3994 requires external capacitors for regulator stability. The LP3994 is specifically designed for portable applications requiring minimum board space and smallest components. These capacitors must be correctly selected for good performance and to ensure that their value remains within specification over the full operating range.

INPUT CAPACITOR

An input capacitor is required for optimum operation and to ensure stability within the range of specified transient conditions. It is recommended that a 1.0 μ F capacitor be connected between the LP3994 input pin and ground (this capacitance value may be increased without limit).

This capacitor must be located a distance of not more than 1cm from the input pin and returned to a clean analogue ground. Any good quality ceramic, tantalum, or film capacitor may be used at the input.

Important: Tantalum capacitors can suffer catastrophic failures due to surge current when connected to a low-impedance source of power (like a battery or a very large capacitor). If a tantalum capacitor is used at the input, it must be guaranteed by the manufacturer to have a surge current rating sufficient for the application.

There are no requirements for the ESR (Equivalent Series Resistance) on the input capacitor, but tolerance and temperature coefficient must be considered when selecting the capacitor to ensure the capacitance will remain \approx 1.0 μ F over the entire operating temperature range.

OUTPUT CAPACITOR

Correct selection of the output capacitor is essential to ensure stable operation in the intended application.

The output capacitor must meet all the requirements specified in the recommended capacitor table over all conditions in the application. These conditions include DC-Bias, frequency and temperature. Unstable operation may result if the capacitance drops below the minimum specified value. (See the Capacitor Characteristics section).

The LP3994 is designed specifically to work with very small ceramic output capacitors. A 1.0 μ F ceramic capacitor (type X7R) with ESR between 5m Ω to 500m Ω , is suitable in the LP3994 application circuit. X5R type capacitors may be used but have a narrower temperature range. With these capacitors and others types (Y5V, Z6U) that may be used, selection of the capacitor for any application is dependant on the range of operating conditions and temperature range for that application. (see section on Capacitor Characteristics).

It may also be possible to use tantalum or film capacitors at the device output, C_{OUT} (or V_{OUT}), but these are not as attractive for reasons of size and cost (see the section Capacitor Characteristics).

It is also recommended that the output capacitor be placed within 1cm from the output pin and returned to a clean ground line.

NO-LOAD STABILITY

The LP3994 will remain stable and in regulation with no external load. This is an important consideration in some circuits, for example CMOS RAM keep-alive applications.

CAPACITOR CHARACTERISTICS

The LP3994 is designed to work with ceramic capacitors on the input and output to take advantage of the benefits they offer. For capacitance values around the 1 μ F value, ceramic capacitors give the circuit designer the best design options in terms of low cost and minimal area. Ceramic capacitors have the lowest ESR values, thus making them best for eliminating high frequency noise. The ESR of a typical 1 μ F ceramic capacitor is in the range of 20m Ω to 40m Ω , which easily meets the ESR requirement for stability for the LP3994.

For both input and output capacitors careful interpretation of the capacitor specification is required to ensure correct device operation. The capacitor value can change greatly dependant on the conditions of operation and capacitor type.

In particular the output capacitor selection should take account of all the capacitor parameters to ensure that the specification is met within the application. Capacitance value can vary with DC bias conditions as well as temperature and frequency of operation. Capacitor values will also show some decrease over time due to aging. The capacitor parameters are also dependant on the particular case size with smaller sizes giving poorer performance figures in general. A study of manufacturers data on 0402 case size capacitors shows that these devices may drop below the minimum specified capacitance due to DC-Bias conditions in conjunction with other parameters such as temperature and are thus not recommended for use.

The temperature performance of ceramic capacitors varies by type. Capacitor type X7R is specified with a tolerance of \pm 15% over the temperature range -55 $^{\circ}$ C to +125 $^{\circ}$ C. The X5R has a similar tolerance over the reduced temperature range of -55 $^{\circ}$ C to +85 $^{\circ}$ C. Most large value ceramic capacitors (\geq 2.2 μ F) are manufactured with Z5U or Y5V temperature characteristics, which results in the capacitance dropping by more than 50% as the temperature goes from 25 $^{\circ}$ C to 85 $^{\circ}$ C. Therefore X7R is recommended over these other capacitor types in applications where the temperature will change significantly above or below 25 $^{\circ}$ C.

Tantalum capacitors are less desirable than ceramic for use as output capacitors because they are more expensive when comparing equivalent capacitance and voltage ratings in the 1 μ F to 4.7 μ F range.

Another important consideration is that tantalum capacitors have higher ESR values than equivalent size ceramics. This means that while it may be possible to find a tantalum capacitor with an ESR value within the stable range, it would have to be larger in capacitance (which means bigger and more costly) than a ceramic capacitor with the same ESR value. It should also be noted that the ESR of a typical tantalum will increase about 2:1 as the temperature goes from 25 $^{\circ}$ C down to -40 $^{\circ}$ C, so some guard band must be allowed.

Application Hints (Continued)

["LP3994LD-1.8"供应商](#)

The LP3994 features an active high Enable pin, V_{EN} , which turns the device on when pulled high. When not enabled the regulator output is off and the device typically consumes 1nA.

If the application does not require the Enable switching feature, the V_{EN} pin should be tied to V_{IN} to keep the regulator output permanently on.

To ensure proper operation, the signal source used to drive the V_{EN} input must be able to swing above and below the specified turn-on/off voltage thresholds listed in the Electrical Characteristics section under V_{IL} and V_{IH} .

Physical Dimensions inches (millimeters) unless otherwise noted

[查询"LP3994LD-1.8"供应商](#)

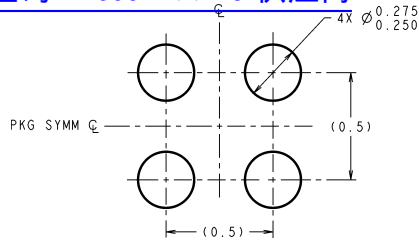

DIMENSIONS ARE IN MILLIMETERS
DIMENSIONS IN () FOR REFERENCE ONLY

LAND PATTERN RECOMMENDATION

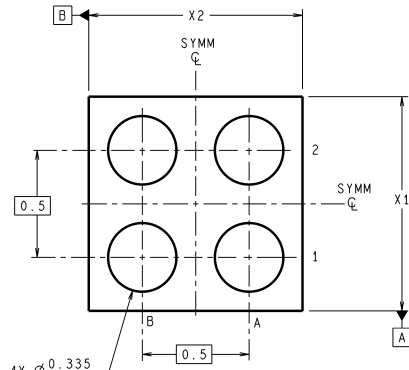
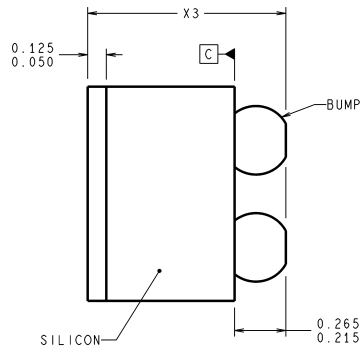
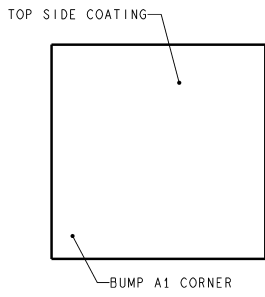

⊕ 0.001 ⊕ C A ⊕ B ⊕

TLA04XXX (Rev C)

micro SMD, 4 Bump, Package (TLA04)
NS Package Number TLA04AAA
The dimensions for X1, X2 and X3 are given as:
X1 = 1.014 +/- 0.03mm
X2 = 1.014 +/- 0.03mm
X3 = 0.600 +/- 0.075mm

Physical Dimensions

inches (millimeters) unless otherwise noted (Continued)

查询"LP3994LD-1.8"供应商

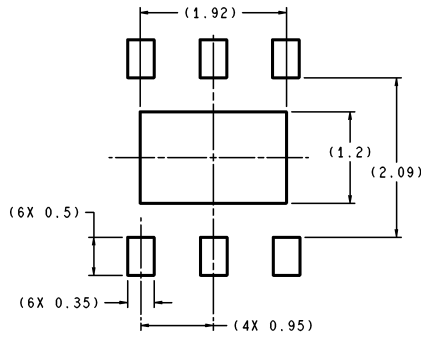

DIMENSIONS ARE IN MILLIMETERS

RECOMMENDED LAND PATTERN
1:1 RATIO WITH PKG SOLDER PADS

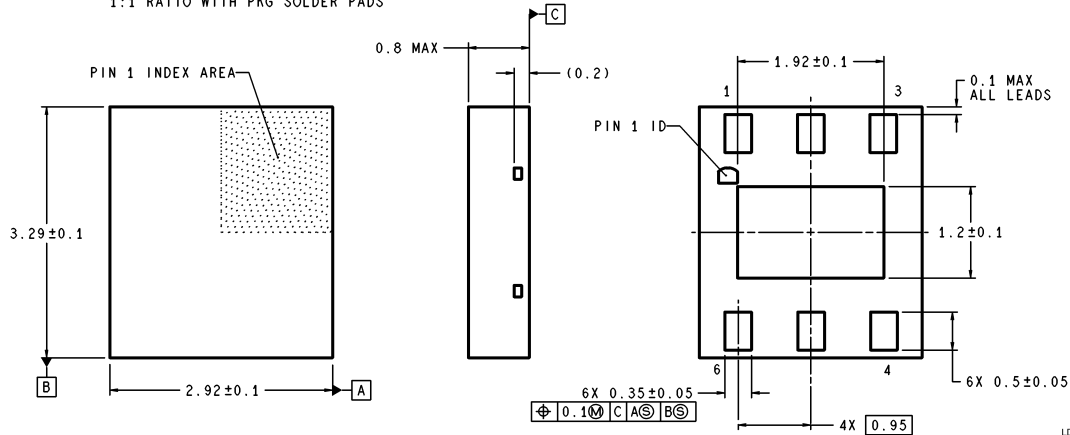

LDE06A (Rev A)

LLP, 6 Lead, Package (SOT23 Land)
NS Package Number LDE06A

LIFE SUPPORT POLICY

NATIONAL'S PRODUCTS ARE NOT AUTHORIZED FOR USE AS CRITICAL COMPONENTS IN LIFE SUPPORT DEVICES OR SYSTEMS WITHOUT THE EXPRESS WRITTEN APPROVAL OF THE PRESIDENT AND GENERAL COUNSEL OF NATIONAL SEMICONDUCTOR CORPORATION. As used herein:

1. Life support devices or systems are devices or systems which, (a) are intended for surgical implant into the body, or (b) support or sustain life, and whose failure to perform when properly used in accordance with instructions for use provided in the labeling, can be reasonably expected to result in a significant injury to the user.
2. A critical component is any component of a life support device or system whose failure to perform can be reasonably expected to cause the failure of the life support device or system, or to affect its safety or effectiveness.

BANNED SUBSTANCE COMPLIANCE

National Semiconductor certifies that the products and packing materials meet the provisions of the Customer Products Stewardship Specification (CSP-9-111C2) and the Banned Substances and Materials of Interest Specification (CSP-9-111S2) and contain no "Banned Substances" as defined in CSP-9-111S2.



National Semiconductor
Americas Customer
Support Center
Email: new.feedback@nsc.com
Tel: 1-800-272-9959

National Semiconductor
Europe Customer Support Center
Fax: +49 (0) 180-530 85 86
Email: europe.support@nsc.com
Deutsch Tel: +49 (0) 69 9508 6208
English Tel: +44 (0) 870 24 0 2171
Français Tel: +33 (0) 1 41 91 8790

National Semiconductor
Asia Pacific Customer
Support Center
Email: ap.support@nsc.com

National Semiconductor
Japan Customer Support Center
Fax: 81-3-5639-7507
Email: jpn.feedback@nsc.com
Tel: 81-3-5639-7560

www.national.com