

Low $V_{CE(SAT)}$ PNP Epitaxial Planar Transistor

BTA1300A3

Description

The BTA1300A3 is designed especially for use in strobo flash and medium power amplifier applications.

Features

- High DC current gain and excellent hFE linearity.
 HFE(1)=140—600($V_{CE}=-1V, I_C=-0.5A$)
 HFE(2)=60(min), 120(typ.)($V_{CE}=-1V, I_C=-4A$)
- Low Saturation Voltage
 $V_{CE(sat)}=-0.5V(max)(I_C=-2A, I_B=-50mA)$.

Symbol

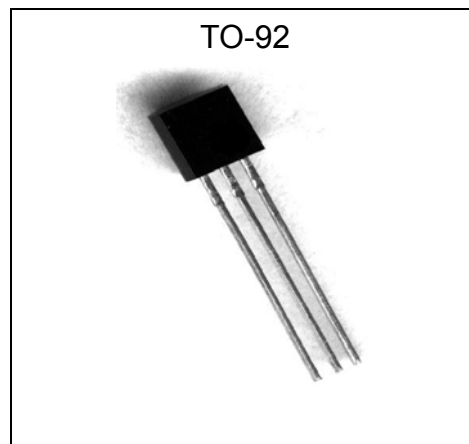
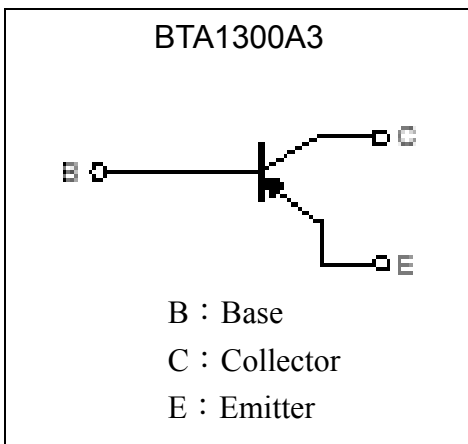

Absolute Maximum Ratings ($T_a=25^{\circ}C$)

Parameter	Symbol	Limits	Unit
Collector-Base Voltage	VCBO	-20	V
Collector-Emitter Voltage	VCES	-20	V
Collector-Emitter Voltage	VCEO	-10	V
Emitter-Base Voltage	VEBO	-6	V
Collector Current(DC)	I_C	-2	A
Collector Current(Pulsed)(Note 1)	I_{CP}	-5	
Power Dissipation	P_d	750	mW
Junction Temperature	T_j	150	$^{\circ}C$
Storage Temperature	T_{stg}	-55~+150	$^{\circ}C$

Note 1: Single pulse, $P_w \leq 10ms, Duty\ Cycle \leq 30\%$.

Characteristics (Ta=25°C)

Symbol	Min.	Typ.	Max.	Unit	Test Conditions
BVCBO	-20	-	-	V	IC=-50uA
BVCEO	-10	-	-	V	IC=-10mA
BVEBO	-6	-	-	V	IE=-1mA
ICBO	-	-	-0.1	uA	VCB=-20V
IEBO	-	-	-0.1	uA	VEB=-6V
*VCE(sat)	-	-	-0.5	V	IC=-2A, IB=-50mA
*VBE(on)	-	-	-1.5	V	VCE=-1V, IC=-2A
*hFE 1	140	-	600	-	VCE=-1V, IC=-500mA
*hFE 2	60	120	-	-	VCE=-1V, IC=-4A
fT	-	140	-	MHz	VCE=-1V, IE=500mA, f=100MHz
Cob	-	50	-	pF	VCB=-10V, IE=0A, f=1MHz

*Pulse Test: Pulse Width ≤380us, Duty Cycle≤2%

Classification Of hFE

Rank	Y	GR	BL
Range	140~280	200~400	300~600

Characteristic Curves

Current Gain vs Collector Current

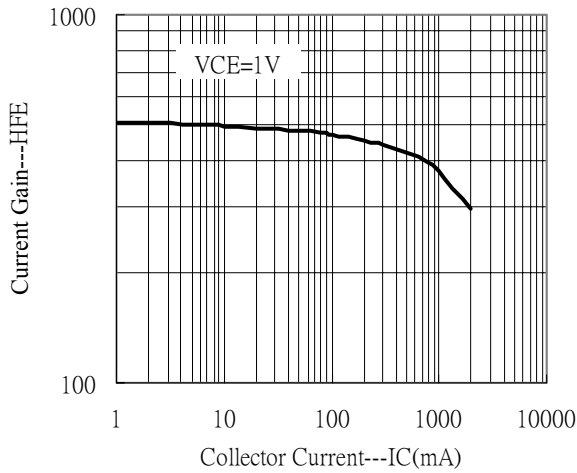

Saturation Voltage vs Collector Current

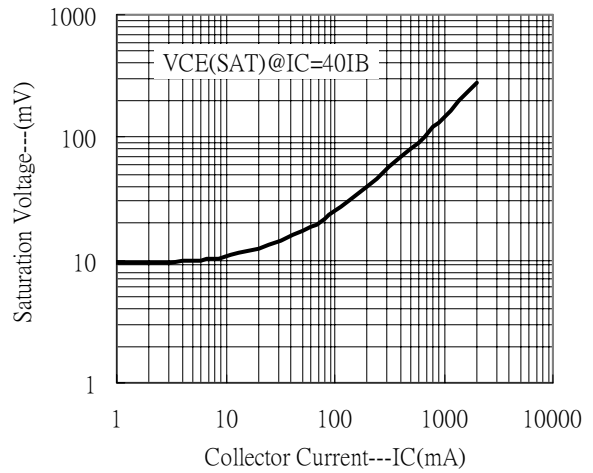

ON Voltage vs Collector Current

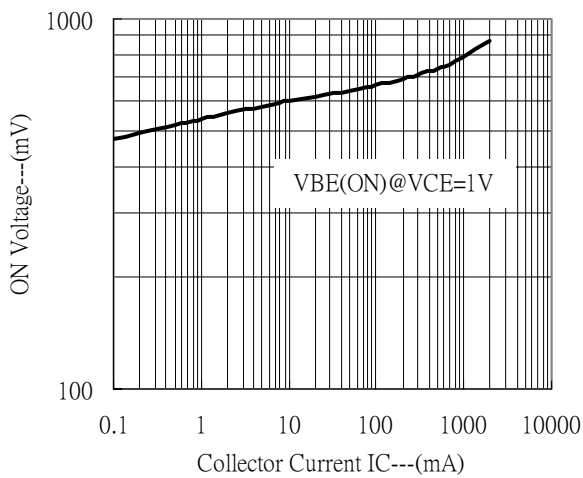

Power Derating Curve

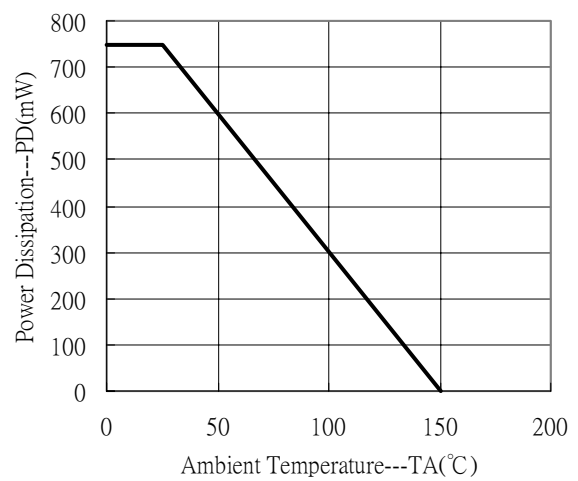

TO-92 Dimension

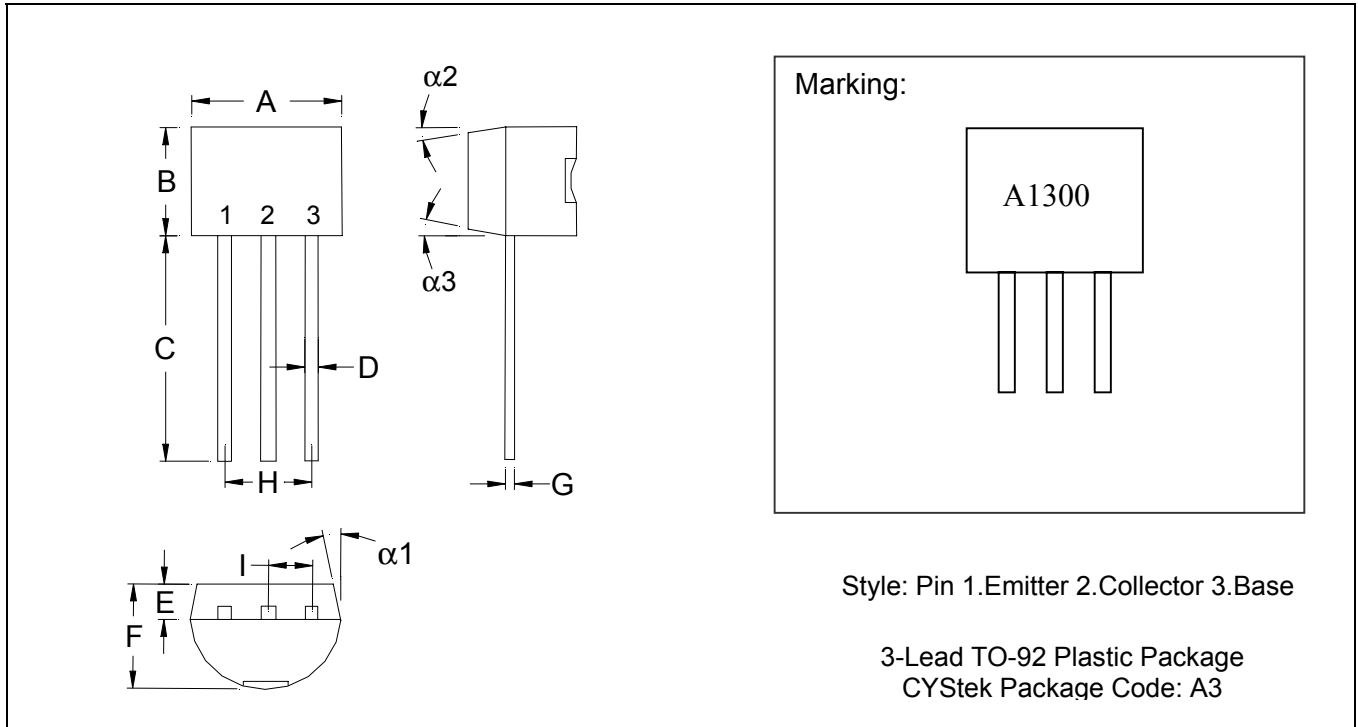

*: Typical

DIM	Inches		Millimeters		DIM	Inches		Millimeters	
	Min.	Max.	Min.	Max.		Min.	Max.	Min.	Max.
A	0.1704	0.1902	4.33	4.83	G	0.0142	0.0220	0.36	0.56
B	0.1704	0.1902	4.33	4.83	H	-	*0.1000	-	*2.54
C	0.5000	-	12.70	-	I	-	*0.0500	-	*1.27
D	0.0142	0.0220	0.36	0.56	α1	-	*5°	-	*5°
E	-	*0.0500	-	*1.27	α2	-	*2°	-	*2°
F	0.1323	0.1480	3.36	3.76	α3	-	*2°	-	*2°

Notes: 1. Controlling dimension: millimeters.
 2. Maximum lead thickness includes lead finish thickness, and minimum lead thickness is the minimum thickness of base material.
 3. If there is any question with packing specification or packing method, please contact your local CYStek sales office.

Material:

- Lead: 42 Alloy ; solder plating
- Mold Compound: Epoxy resin family, flammability solid burning class: UL94V-0

Important Notice:

- All rights are reserved. Reproduction in whole or in part is prohibited without the prior written approval of CYStek.
- CYStek reserves the right to make changes to its products without notice.
- CYStek **semiconductor products are not warranted to be suitable for use in Life-Support Applications, or systems.**
- CYStek assumes no liability for any consequence of customer product design, infringement of patents, or application assistance.