

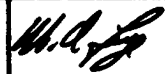



REVISIONS													
LTR	DESCRIPTION	DATE (YR-MO-DA)	APPROVED										
A	Change t <sub>PLH</sub> , t <sub>PHL</sub> , and footnotes in table I. Add figure 3. Editorial changes throughout. Change footnote 1/ in 1.3.	1988 APR 04											

REV													
SHEET													
REV													
SHEET													
REV STATUS OF SHEETS	REV	A	A	A	A	A	A	A	A	A	A		
	SHEET	1	2	3	4	5	6	7	8	9	10		

PMIC N/A	PREPARED BY 	DEFENSE ELECTRONICS SUPPLY CENTER DAYTON, OHIO 45444
<b>STANDARDIZED MILITARY DRAWING</b>	CHECKED BY 	MICROCIRCUIT, DIGITAL, BIPOLAR, ADVANCED LOW POWER SCHOTTKY TTL, NOR GATES, MONOLITHIC SILICON
	APPROVED BY 	THIS DRAWING IS AVAILABLE FOR USE BY ALL DEPARTMENTS AND AGENCIES OF THE DEPARTMENT OF DEFENSE
	DRAWING APPROVAL DATE 17 AUGUST 1987	SIZE <b>A</b>
AMSC N/A	REVISION LEVEL A	CAGE CODE <b>67268</b>
		SHEET 1 OF 10

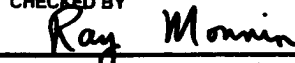
DESC FORM 193  
SEP 87

U.S. GOVERNMENT PRINTING OFFICE: 1987 - 748-129/60911  
5962-E824-4

DISTRIBUTION STATEMENT A. Approved for public release; distribution is unlimited.

1. SCOPE

1.1 Scope. This drawing describes device requirements for class B microcircuits in accordance with 1.2.1 of MIL-STD-883, "Provisions for the use of MIL-STD-883 in conjunction with compliant non-JAN devices".

1.2 Part number. The complete part number shall be as shown in the following example:

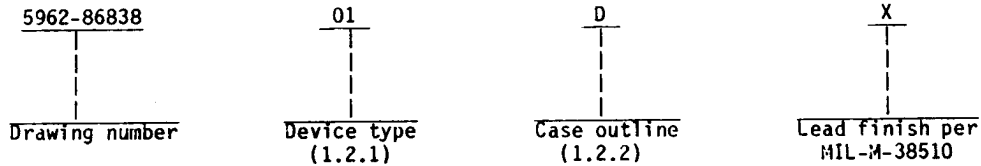

1.2.1 Device type. The device type shall identify the circuit function as follows:

Device type	Generic number	Circuit function
01	54ALS27	Triple, three-input, positive NOR gates

1.2.2 Case outlines. The case outlines shall be as designated in appendix C of MIL-M-38510, and as follows:

Outline letter	Case outline
D	F-2 (14-lead, .390" x .260" x .085" maximum), flat package
2	C-2 (20-terminal, .358" x .358" x .100" maximum), square chip carrier package

1.3 Absolute maximum ratings.

Supply voltage range - - - - -	-0.5 V dc minimum to +7.0 V dc maximum
Input voltage range- - - - -	-1.5 V dc at -18 mA to +7.0 V dc
Storage temperature- - - - -	-65°C to +150°C
Maximum power dissipation (P <sub>D</sub> ) per device 1/ - - -	22.0 mW
Lead temperature (soldering, 10 seconds) - - - -	+300°C
Thermal resistance, junction-to-case (θ <sub>JC</sub> ) - - - -	See MIL-M-38510, appendix C
Junction temperature (T <sub>J</sub> ) - - - - -	+175°C

1.4 Recommended operating conditions.

Supply voltage range (V <sub>CC</sub> ) - - - - -	+4.5 V dc minimum to +5.5 V dc maximum
Minimum high level input voltage (V <sub>IH</sub> ) - - - - -	2.0 V dc
Maximum low level input voltage (V <sub>IL</sub> ):	
T <sub>C</sub> = +125°C - - - - -	0.7 V dc
T <sub>C</sub> = -55°C - - - - -	0.8 V dc
T <sub>C</sub> = +25°C - - - - -	0.8 V dc
Case operating temperature range (T <sub>C</sub> ) - - - - -	-55°C to +125°C

1/ Maximum power dissipation is defined as V<sub>CC</sub>\*I<sub>CC</sub>, and must withstand the added P<sub>D</sub> due to short circuit test, e.g., I<sub>O</sub>.

<b>STANDARDIZED MILITARY DRAWING</b> DEFENSE ELECTRONICS SUPPLY CENTER DAYTON, OHIO 45444	SIZE <b>A</b>	5962-86838
	REVISION LEVEL <b>A</b>	SHEET <b>2</b>

2. APPLICABLE DOCUMENTS

2.1 Government specification and standard. Unless otherwise specified, the following specification and standard, of the issue listed in that issue of the Department of Defense Index of Specifications and Standards specified in the solicitation, form a part of this drawing to the extent specified herein.

SPECIFICATION

MILITARY

MIL-M-38510 - Microcircuits, General Specification for.

STANDARD

MILITARY

MIL-STD-883 - Test Methods and Procedures for Microelectronics.

(Copies of the specification and standard required by manufacturers in connection with specific acquisition functions should be obtained from the contracting activity or as directed by the contracting activity.)

2.2 Order of precedence. In the event of a conflict between the text of this drawing and the references cited herein, the text of this drawing shall take precedence.

3. REQUIREMENTS

3.1 Item requirements. The individual item requirements shall be in accordance with 1.2.1 of MIL-STD-883, "Provisions for the use of MIL-STD-883 in conjunction with compliant non-JAN devices" and as specified herein.

3.2 Design, construction, and physical dimensions. The design, construction, and physical dimensions shall be as specified in MIL-M-38510 and herein.

3.2.1 Terminal connections and logic diagram. The terminal connections and logic diagram shall be as specified on figure 1.

3.2.2 Truth table. The truth table shall be as specified on figure 2.

3.2.3 Switching waveform and test circuit. The switching waveform and test circuit shall be as specified on figure 3.

3.2.4 Case outlines. The case outlines shall be in accordance with 1.2.2 herein.

3.3 Electrical performance characteristics. Unless otherwise specified, the electrical performance characteristics are as specified in table I and apply over the full case operating temperature range.

3.4 Marking. Marking shall be in accordance with MIL-STD-883 (see 3.1 herein). The part shall be marked with the part number listed in 1.2 herein. In addition, the manufacturer's part number may also be marked as listed in 6.4 herein.

<b>STANDARDIZED MILITARY DRAWING</b> DEFENSE ELECTRONICS SUPPLY CENTER DAYTON, OHIO 45444	SIZE <b>A</b>	5962-86838
	REVISION LEVEL A	SHEET 3

TABLE I. Electrical performance characteristics. 1/ 2/

Test	Symbol	Conditions -55°C < T <sub>C</sub> < +125°C unless otherwise specified		Group A subgroups	Limits		Unit
					Min	Max	
High level output voltage	V <sub>OH</sub>	V <sub>IH</sub> = 2.0 V V <sub>CC</sub> = 4.5 V I <sub>OH</sub> = -0.4 mA <u>3/ 4/</u>	V <sub>IL</sub> = 0.8 V	1,3	2.5		V
			V <sub>IL</sub> = 0.7 V	2			
Low level output voltage	V <sub>OL</sub>	V <sub>IH</sub> = 2.0 V V <sub>CC</sub> = 4.5 V I <sub>OL</sub> = 4.0 mA <u>5/ 4/</u>	V <sub>IL</sub> = 0.8 V	1,3	0.4		V
			V <sub>IL</sub> = 0.7 V	2			
Input clamp voltage	V <sub>IC</sub>	V <sub>CC</sub> = 4.5 V I <sub>IN</sub> = -18 mA		1,2,3	-1.5		V
High level input current	I <sub>IH1</sub>	V <sub>CC</sub> = 5.5 V V <sub>IN</sub> = 2.7 V All other inputs = 0.0 V		1,2,3	20		μA
	I <sub>IH2</sub>	V <sub>CC</sub> = 5.5 V V <sub>IN</sub> = 7.0 V All other inputs = 0.0 V		1,2,3	100		μA
Low level input current	I <sub>IL</sub>	V <sub>CC</sub> = 5.5 V V <sub>IN</sub> = 0.4 V All other inputs = 4.5 V		1,2,3	-0.1		mA
Output current	I <sub>O</sub>	V <sub>CC</sub> = 5.5 V V <sub>OUT</sub> = 2.25 V <u>6/</u>		1,2,3	-30	-112	mA
High level supply current	I <sub>CCH</sub>	V <sub>CC</sub> = 5.5 V V <sub>IN</sub> ≤ 0.4 V (All inputs)		1,2,3	1.8		mA
Low level supply current	I <sub>CCL</sub>	V <sub>CC</sub> = 5.5 V V <sub>IN</sub> ≥ 4.5 V (All inputs)		1,2,3	4.0		mA
Functional tests		See 4.3.1c <u>7/</u>		7,8			
Propagation delay time, any input to Y	t <sub>PHL</sub>	V <sub>CC</sub> = 4.5 V to 5.5 V C <sub>L</sub> = 50 pF R <sub>L</sub> = 500Ω <u>8/</u>		9,10,11	1	8	ns
	t <sub>PLH</sub>	See figure 3		9,10,11	2	16	ns

1/ Unused inputs that do not directly control the pin under test must be ≥ 2.5 V or ≤ 0.4 V.

2/ Unused inputs shall not exceed 5.5 V or go less than 0.0 V. No inputs shall be floated.

<b>STANDARDIZED MILITARY DRAWING</b> DEFENSE ELECTRONICS SUPPLY CENTER DAYTON, OHIO 45444	SIZE <b>A</b>	5962-86838
	REVISION LEVEL    A	SHEET    4

- 3/ One input to gate under test must =  $V_{IL}$ , the other inputs shall be  $\leq 0.7 V$ .
- 4/ All outputs must be tested. In the case where only one input at  $V_{IL}$  maximum or  $V_{IH}$  minimum produces the proper output state, the test must be performed with each input being selected as the  $V_{IL}$  maximum or  $V_{IH}$  minimum input.
- 5/ One input to gate under test must =  $V_{IH}$ , the other inputs shall be  $\leq 0.7 V$ .
- 6/ The output conditions have been chosen to produce a current that closely approximates one-half of the true short circuit output current,  $I_{OS}$ . Not more than one output will be tested at a time and the duration of the test condition shall not exceed one second.
- 7/ Functional tests shall be conducted at input test conditions of  $0.0 V \leq V_{IL} \leq V_{OL}$  and  $V_{OH} \leq V_{IH} \leq V_{CC}$ .
- 8/ The propagation delay limits are based on single output switching. Unused inputs =  $3.5 V$  or  $\leq 0.3 V$ .

3.5 Certificate of compliance. A certificate of compliance shall be required from a manufacturer in order to be listed as an approved source of supply in 6.4. The certificate of compliance submitted to DESC-ECS prior to listing as an approved source of supply shall state that the manufacturer's product meets the requirements of MIL-STD-883 (see 3.1 herein) and the requirements herein.

3.6 Certificate of conformance. A certificate of conformance as required in MIL-STD-883 (see 3.1 herein) shall be provided with each lot of microcircuits delivered to this drawing.

3.7 Notification of change. Notification of change to DESC-ECS shall be required in accordance with MIL-STD-883 (see 3.1 herein).

3.8 Verification and review. DESC, DESC's agent, and the acquiring activity retain the option to review the manufacturer's facility and applicable required documentation. Offshore documentation shall be made available onshore at the option of the reviewer.

4. QUALITY ASSURANCE PROVISIONS

4.1 Sampling and inspection. Sampling and inspection procedures shall be in accordance with section 4 of MIL-M-38510 to the extent specified in MIL-STD-883 (see 3.1 herein).

4.2 Screening. Screening shall be in accordance with method 5004 of MIL-STD-883, and shall be conducted on all devices prior to quality conformance inspection. The following additional criteria shall apply:

- a. Burn-in test, method 1015 of MIL-STD-883.
  - (1) Test condition A, B, C, or D using the circuit submitted with the certificate of compliance (see 3.5 herein).
  - (2)  $T_A = +125^\circ C$ , minimum.
- b. Interim and final electrical test parameters shall be as specified in table II herein, except interim electrical parameter tests prior to burn-in are optional at the discretion of the manufacturer.

4.3 Quality conformance inspection. Quality conformance inspection shall be in accordance with method 5005 of MIL-STD-883 including groups A, B, C, and D inspections. The following additional criteria shall apply.

<b>STANDARDIZED MILITARY DRAWING</b> DEFENSE ELECTRONICS SUPPLY CENTER DAYTON, OHIO 45444	SIZE <b>A</b>	5962-86838
	REVISION LEVEL A	SHEET 5

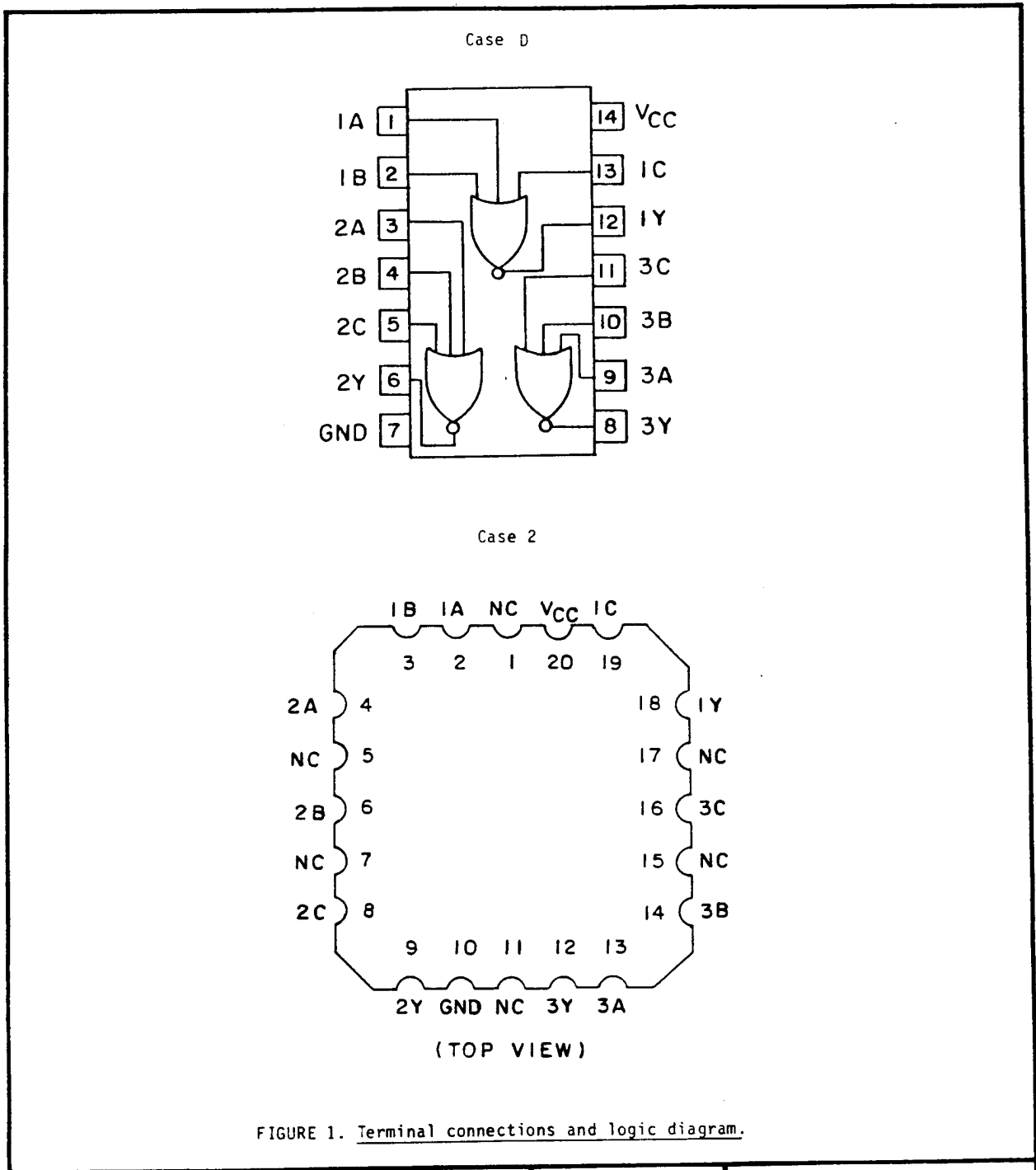

<b>STANDARDIZED MILITARY DRAWING</b> DEFENSE ELECTRONICS SUPPLY CENTER DAYTON, OHIO 45444	SIZE <b>A</b>	5962-86838
	REVISION LEVEL A	SHEET 6

DESC FORM 193A  
SEP 87

U.S. GOVERNMENT PRINTING OFFICE: 1967-748 (25-4894)

Inputs			Output
A	B	C	Y
H	X	X	L
X	H	X	L
X	X	H	L
L	L	L	H

H = High voltage level  
L = Low voltage level  
X = Irrelevant

FIGURE 2. Truth table.

<b>STANDARDIZED MILITARY DRAWING</b> DEFENSE ELECTRONICS SUPPLY CENTER DAYTON, OHIO 45444	<b>SIZE</b> A		5962-86838
		<b>REVISION LEVEL</b> A	<b>SHEET</b> 7

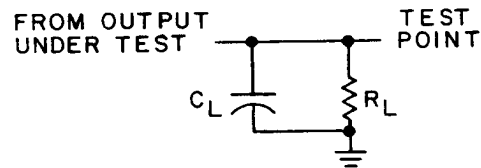

LOAD CIRCUIT FOR BI-STATE TOTEM-POLE OUTPUTS

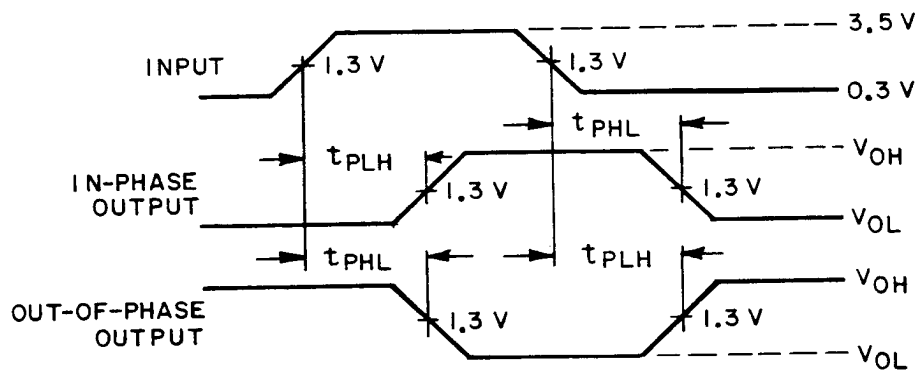

NOTES:

1.  $C_L$  includes probe and jig capacitance.
2. All input pulses have the following characteristics:  $PRR \leq 10$  MHz, duty cycle = 50%,  $t_r = t_f = 3$  ns  $\pm 1$  ns.
3. The outputs are measured one at a time with one input transition per measurement.

FIGURE 3. Switching waveform and test circuit.

<b>STANDARDIZED MILITARY DRAWING</b> DEFENSE ELECTRONICS SUPPLY CENTER DAYTON, OHIO 45444	SIZE <b>A</b>	5962-86838
		REVISION LEVEL    A    SHEET    8

DESC FORM 193A  
SEP 87

U.S. GOVERNMENT PRINTING OFFICE: 1967-748-129-6093



4.3.1 Group A inspection.

- a. Tests shall be as specified in table II herein.
- b. Subgroups 4, 5, and 6 in table I, method 5005 of MIL-STD-883 shall be omitted.
- c. Subgroups 7 and 8 tests shall verify the truth table as specified on figure 2 herein.

4.3.2 Groups C and D inspections.

- a. End-point electrical parameters shall be as specified in table II herein.
- b. Steady-state life test conditions, method 1005 of MIL-STD-883.
  - (1) Test condition A, B, C, or D using the circuit submitted with the certificate of compliance (see 3.5 herein).
  - (2)  $T_A = +125^\circ\text{C}$ , minimum.
  - (3) Test duration: 1,000 hours, except as permitted by method 1005 of MIL-STD-883.

TABLE II. Electrical test requirements.

MIL-STD-883 test requirements	Subgroups (per method 5005, table I)
Interim electrical parameters (method 5004)	---
Final electrical test parameters (method 5004)	1*, 2, 3, 7, 8, 9, 10, 11
Group A test requirements (method 5005)	1, 2, 3, 7, 8, 9, 10, 11
Groups C and D end-point electrical parameters (method 5005)	1, 2, 3

\* PDA applies to subgroup 1.

5. PACKAGING

5.1 Packaging requirements. The requirements for packaging shall be in accordance with MIL-M-38510.

<b>STANDARDIZED MILITARY DRAWING</b> DEFENSE ELECTRONICS SUPPLY CENTER DAYTON, OHIO 45444	SIZE <b>A</b>	5962-86838
	REVISION LEVEL    A	SHEET    9

6. NOTES

6.1 Intended use. Microcircuits conforming to this drawing are intended for use when military specifications do not exist and qualified military devices that will perform the required function are not available for OEM application. When a military specification exists and the product covered by this drawing has been qualified for listing on QPL-38510, the device specified herein will be inactivated and will not be used for new design. The QPL-38510 product shall be the preferred item for all applications.

6.2 Replaceability. Replaceability is determined as follows:

- a. Microcircuits covered by this drawing will replace the same generic device covered by a contractor-prepared specification or drawing.
- b. When a QPL source is established, the part numbered device specified in this drawing will be replaced by the microcircuit identified as part number M38510/37302B--.

6.3 Comments. Comments on this drawing should be directed to DESC-ECS, Dayton, Ohio 45444, or telephone 513-296-5375.

6.4 Approved sources of supply. Approved sources of supply are listed herein. Additional sources will be added as they become available. The vendors listed herein have agreed to this drawing and a certificate of compliance (see 3.5 herein) has been submitted to DESC-ECS.

Military drawing part number	Vendor CAGE number	Vendor similar part number <u>1/</u>	Replacement military specification part number
5962-8683801DX	27014 18324 01295	54ALS27W/883 54ALS27/BDA SNJ54ALS27W	M38510/37302BDX
5962-86838012X	<u>2/</u> 27014 18324 01295	54ALS27E/883 54ALS27/B2A SNJ54ALS27FK	M38510/37302B2X

1/ Caution. Do not use this number for item acquisition. Items acquired to this number may not satisfy the performance requirements of this drawing.

2/ This device is inactive for new design. Use QPL device.

Vendor CAGE number	Vendor name and address
27014	National Semiconductor Corporation 2900 Semiconductor Drive Santa Clara, CA 95051
18324	Signetics Corporation 4130 South Market Court Sacramento, CA 95834
01295	Texas Instruments, Incorporated P.O. Box 6448 Midland, TX 79701

<b>STANDARDIZED MILITARY DRAWING</b> DEFENSE ELECTRONICS SUPPLY CENTER DAYTON, OHIO 45444	SIZE <b>A</b>	5962-86838
	REVISION LEVEL <b>A</b>	SHEET <b>10</b>

DESC FORM 193A  
SEP 87

☆ U.S. GOVERNMENT PRINTING OFFICE 1987-549-096

011934 - - -