

SILICON PLANAR VOLTAGE REGULATOR DIODE

BZX84C2V4 to 75V

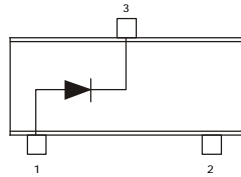
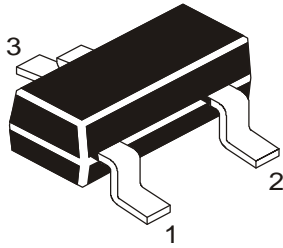

Pin Configuration
 1 = ANODE
 2 = NC
 3 = CATHODE

**SOT-23
 Formed SMD Package**

Low voltage general purpose voltage regulator diode

ABSOLUTE MAXIMUM RATINGS (T_a=25°C)

DESCRIPTION	SYMBOL	VALUE	UNIT
Working Voltage Tolerance		± 5	%
Repetitive Peak Forward Current	I _{FRM}	250	mA
Repetitive Peak Working Current	I _{ZRM}	250	mA
Power Dissipation upto T _a =25°C	*P _D	300	mW
Power Dissipation upto T _c =25°C	**P _D	250	mW
Junction Temperature	T _j	150	°C
Storage Temperature	T _{stg}	- 65 to +150	°C

THERMAL RESISTANCE

Junction to Ambient	*R _{th(j-a)}	420	K/W
---------------------	-----------------------	-----	-----

* Device mounted on a ceramic alumina

** Device mounted on an FR5 printed circuit board

Forward Voltage at V_F <0.9V at 10mA and <1.5V at 200mA

ELECTRICAL CHARACTERISTICS (T_a=25°C unless specified otherwise)

Device	Working Voltage ***V _Z (± 5%) (V) at I _Z test=5mA		Differential Resistance rdiff (W) at I _Z test=5mA	Temperature Coefficient S _Z (mV/K) at I _Z test=5mA		Differential Resistance rdiff (W) at I _Z test=1mA	I _R at V _R mA		Marking
	min	max	max	min	max	max	Max	(V)	
	BZX84C2V4	2.20	2.60	100	-3.5		600	50	
BZX84C2V7	2.50	2.90	100	-3.5		600	20	1.0	Z12
BZX84C3V0	2.80	3.20	95	-3.5		600	10	1.0	Z13
BZX84C3V3	3.10	3.50	95	-3.5		600	5.0	1.0	Z14
BZX84C3V6	3.40	3.80	90	-3.5		600	5.0	1.0	Z15
BZX84C3V9	3.70	4.10	90	-3.5		600	3.0	1.0	Z16
BZX84C4V3	4.00	4.60	90	-3.5		600	3.0	1.0	Z17
BZX84C4V7	4.40	5.00	80	-3.5	0.2	500	3.0	2.0	Z1
BZX84C5V1	4.80	5.40	60	-2.7	1.2	480	2.0	2.0	Z2
BZX84C5V6	5.20	6.00	40	-2.0	2.5	400	1.0	2.0	Z3
BZX84C6V2	5.80	6.60	10	0.4	3.7	150	3.0	4.0	Z4
BZX84C6V8	6.40	7.20	15	1.2	4.5	80	2.0	4.0	Z5
BZX84C7V5	7.00	7.90	15	2.5	5.3	80	1.0	5.0	Z6
BZX84C8V2	7.70	8.70	15	3.2	6.2	80	0.7	5.0	Z7
BZX84C9V1	8.50	9.60	15	3.8	7.0	100	0.5	6.0	Z8
BZX84C10	9.40	10.60	20	4.5	8.0	150	0.2	7.0	Z9

BZX84C2V4_75V Rev_060506E

*** Pulse Test 20ms ≤ tp ≤ 50ms

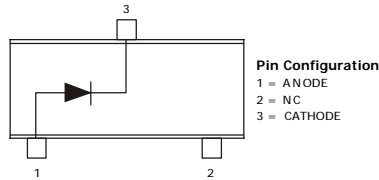
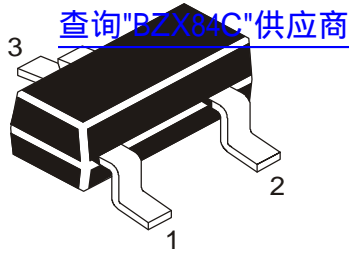

SOT-23
 Formed SMD Package

Forward Voltage at $V_F < 0.9V$ at 10mA and $< 1.5V$ at 200mA

ELECTRICAL CHARACTERISTICS ($T_a=25^\circ C$ unless specified otherwise)

Device	Working Voltage *** $V_Z (\pm 5\%)$ (V) at $I_Z \text{ test}=5\text{mA}$		Differential Resistance rdiff (W) at $I_Z \text{ test}=5\text{mA}$	Temperature Coefficient S_Z (mV/K) at $I_Z \text{ test}=5\text{mA}$		Differential Resistance rdiff (W) at $I_Z \text{ test}=1\text{mA}$	I_R at V_R mA		Marking
	min	max	max	min	max	max	Max	(V)	
BZX84C11	10.40	11.60	20	5.4	9.0	150	0.1	8	Y1
BZX84C12	11.40	12.70	25	6.0	10	150	0.1	8	Y2
BZX84C13	12.40	14.10	30	7.0	11	170	0.1	8	Y3
BZX84C15	13.80	15.60	30	9.2	13	200	0.05	10.5	Y4
BZX84C16	15.30	17.10	40	10.4	14	200	0.05	11.2	Y5
BZX84C18	16.80	19.10	45	12.4	16	225	0.05	12.6	Y6
BZX84C20	18.80	21.20	55	14.4	18	225	0.05	14.0	Y7
BZX84C22	20.80	23.30	55	16.4	20	250	0.05	15.4	Y8
BZX84C24	22.80	25.60	70	18.4	22	250	0.05	16.8	Y9
	at $I_Z \text{ test}=2\text{mA}$		at $I_Z \text{ Test}=2\text{mA}$	at $I_Z \text{ Test}=2\text{mA}$		at $I_Z \text{ Test}=0.5\text{mA}$			
BZX84C27	25.10	28.90	80	21.4	25.3	300	0.05	18.9	Y10
BZX84C30	28.00	32.00	80	24.4	29.4	300	0.05	21.0	Y11
BZX84C33	31.00	35.00	80	27.4	33.4	325	0.05	23.1	Y12
BZX84C36	34.00	38.00	90	30.4	37.4	350	0.05	25.2	Y13
BZX84C39	37.00	41.00	130	33.4	41.2	350	0.05	27.3	Y14
BZX84C43	40.00	46.00	150	37.6	46.6	375	0.05	30.1	Y15
BZX84C47	44.00	50.00	170	42.0	51.8	375	0.05	32.9	Y16
BZX84C51	48.00	54.00	180	46.6	57.2	400	0.05	35.7	Y17
BZX84C56	52.00	60.00	200	52.2	63.8	425	0.05	39.2	Y18
BZX84C62	58.00	66.00	215	58.8	71.6	450	0.05	43.4	Y19
BZX84C68	64.00	72.00	240	65.6	79.8	475	0.05	47.6	Y20
BZX84C75	70.00	79.00	255	73.4	88.6	500	0.05	52.5	Y21

BZX84C2V4_75V Rev_060506E

*** Pulse Test $20\text{ms} \leq t_p \leq 50\text{ms}$

SOT-23 Formed SMD Package

SOT-23 Package Reel Information
Reel specification for W" Packing (13" reel)

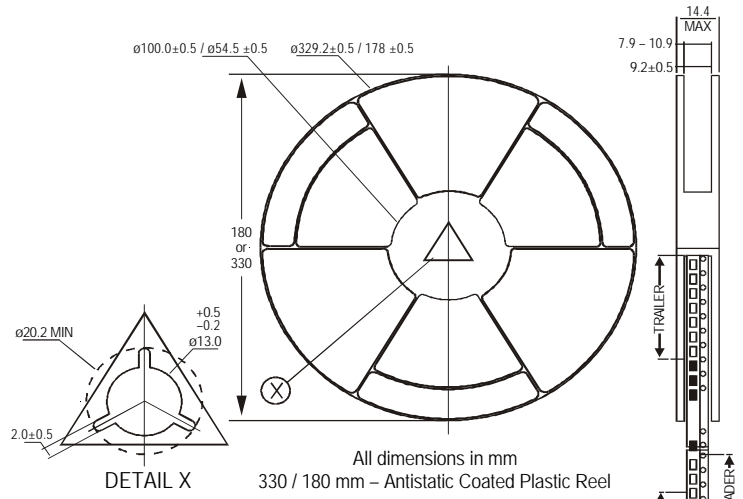
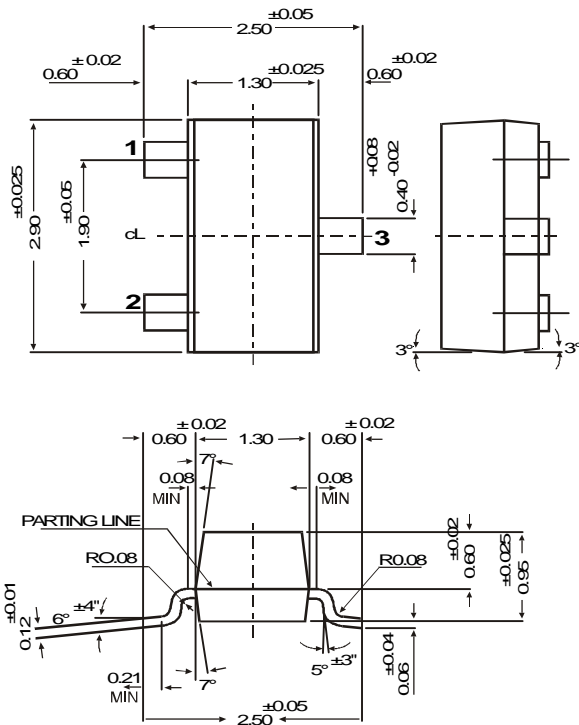

- NOTES:
- | | 8mm Tape
Size of Reel | 8mm Tape
Size of Reel |
|----------------|--------------------------|--------------------------|
| | 330 mm (13") | 180 mm (7") |
| No. of Devices | 10,000 Pcs | 3,000 Pcs |
- The bandolier of 330 mm reel contains at least 10,000 devices.
 - The bandolier of 180 mm reel contains at least 3,000 devices.
 - No more than 0.5% missing devices / reel. 50 empty compartments for 330 mm reel. 15 empty compartments for 180 mm reel.
 - Three consecutive empty places might be found provided this gap is followed by 6 consecutive devices.
 - The carrier tape (leader) starts with at least 75 empty positions (equivalent to 330 mm). In order to fix the carrier tape a self adhesive tape of 20 to 50 mm is applied. At the end of the bandolier at least 40 empty positions (equivalent to 160 mm) are there.

Tape Specification for SOT-23 Surface Mount Device

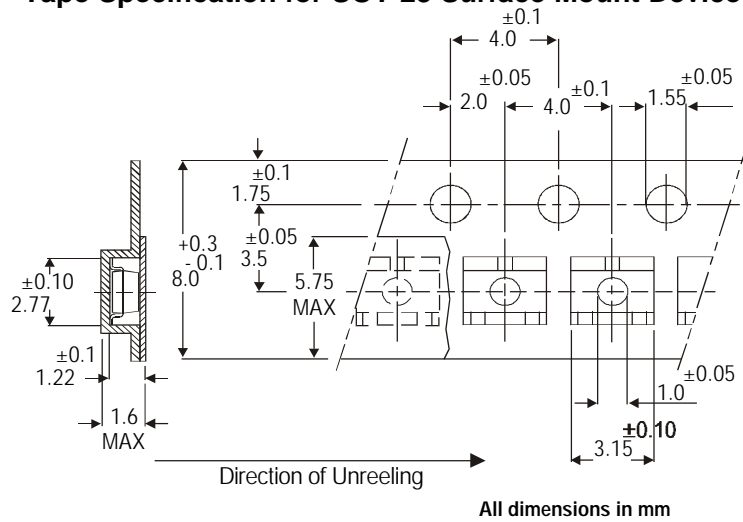

Packing Detail

PACKAGE	STANDARD PACK		INNER CARTON BOX		OUTER CARTON BOX		
	Details	Net Weight/Qty	Size	Qty	Size	Qty	Gr Wt
SOT-23 T&R	3K/reel	136 gm/3K pcs	3" x 7.5" x 7.5"	12 K	17" x 15" x 13.5"	192 K	12 kgs
	10K/reel	415 gm/10K pcs	9" x 9" x 9"	51 K	19" x 19" x 19"	408 K	28 kgs
			13" x 13" x 0.5"	10 K	17" x 15" x 13.5"	300 K	16 kgs

[查询"BZX84C"供应商](#)SOT-23
Formed SMD Package

Component Disposal Instructions

1. CDIL Semiconductor Devices are RoHS compliant, customers are requested to please dispose as per prevailing Environmental Legislation of their Country.
2. In Europe, please dispose as per EU Directive 2002/96/EC on Waste Electrical and Electronic Equipment (WEEE).

Disclaimer

The product information and the selection guides facilitate selection of the CDIL's Semiconductor Device(s) best suited for application in your product(s) as per your requirement. It is recommended that you completely review our Data Sheet(s) so as to confirm that the Device(s) meet functionality parameters for your application. The information furnished in the Data Sheet and on the CDIL Web Site/CD are believed to be accurate and reliable. CDIL however, does not assume responsibility for inaccuracies or incomplete information. Furthermore, CDIL does not assume liability whatsoever, arising out of the application or use of any CDIL product; neither does it convey any license under its patent rights nor rights of others. These products are not designed for use in life saving/support appliances or systems. CDIL customers selling these products (either as individual Semiconductor Devices or incorporated in their end products), in any life saving/support appliances or systems or applications do so at their own risk and CDIL will not be responsible for any damages resulting from such sale(s).

CDIL strives for continuous improvement and reserves the right to change the specifications of its products without prior notice.



CDIL is a registered Trademark of
Continental Device India Limited

C-120 Naraina Industrial Area, New Delhi 110 028, India.

Telephone + 91-11-2579 6150, 4141 1112 Fax + 91-11-2579 5290, 4141 1119

email@cdil.com www.cdilsemi.com