

IGBT MODULE (F series)

■ Features

- Low Saturation Voltage
- Voltage Drive
- Isolated Package

■ Applications

- Ideal for Shunt Regulator Application
- Inverter for Motor Drive
- AC and DC Servo Drive Amplifier
- Uninterruptible Power Supply
- Industrial Machines, such as Welding Machines

■ Maximum Ratings and Characteristics

● Absolute Maximum Ratings

Items	Symbols	Ratings	Units
Collector-Emitter Voltage	V _{CEs}	1200	V
Gate-Emitter Voltage	V _{GES}	±20	V
Collector Current	Continuous	I _c	25
	1ms	I _{c pulse}	50
	Continuous	-I _c	25
	1ms	-I _{c pulse}	50
Max. Power Dissipation	P _c	220	W
Operating Temperature	T _j	+150	°C
Storage Temperature	T _{stg}	-40 to +125	°C
Isolation Voltage	AC. 1min.	V _{is}	2500
Screw Torque	Mounting *1	3.5	N·m
	Terminals *1	3.5	

*1 Recommendable Value 2.5 to 3.5 N·m (M5)

● Electrical Characteristics (T_j=25°C)

Items	Symbols	Test Conditions	Min.	Typ.	Max.	Units
Zero Gate Voltage Collector Current	I _{CEs}	V _{GE} =0V V _{CE} =1200V T _j =25°C			1.0	mA
		V _{GE} =0V V _{CE} =1200V T _j =125°C			—	mA
Gate-Emitter Leakage Current	I _{GES}	V _{CE} =0V V _{GE} =±20V			100	nA
Gate-Emitter Threshold Voltage	V _{GE(th)}	V _{CE} =20V I _c =25mA	3.0		6.0	V
Collector-Emitter Saturation Voltage	V _{CE(sat)}	V _{GE} =15V I _c =25A			2.5	V
Input Capacitance	C _{ies}	V _{GE} =0V		4500		pF
Output Capacitance	C _{oes}	V _{CE} =10V		—		
Reverse Transfer Capacitance	C _{res}	f=1MHz		—		
Turn-on Time	t _{on}	V _{CC} =600V I _c =25A	Resistive load		0.8	μs
	t _r				0.6	
Turn-off Time	t _{off}	V _{GE} =±15V R _G =50Ω	Inductive load		1.5	μs
	t _f				1.0	
Diode Forward On-Voltage	V _F	I _F =25A, V _{GE} =0V			2.5	V
Reverse Recovery Time	t _{rr}	I _F =25A, -di/dt=75A/μs V _{GE} =-10V			350	ns

● Thermal Characteristics

Items	Symbols	Test Conditions	Min.	Typ.	Max.	Units
Thermal Resistance	R _{th(j-c)}	IGBT			0.568	°C/W
	R _{th(j-c)}	Diode			1.33	
	R _{th(c-f)}	With Thermal compound		0.05		

■ Outline Drawings

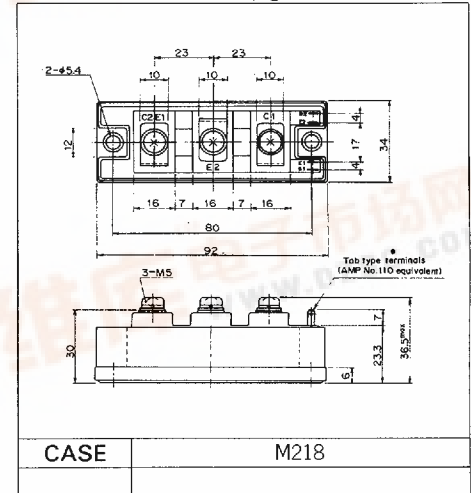

■ Equivalent Circuit Schematic

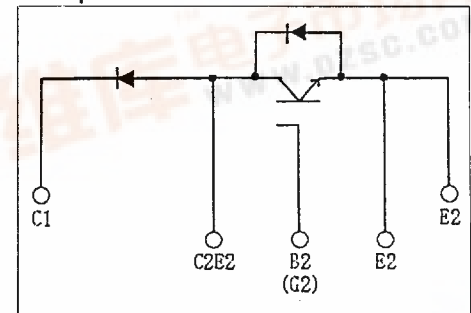

■ 查询"1MBI25FE-120"供应商

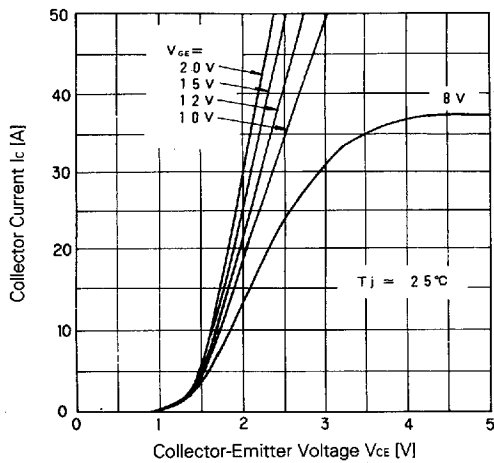

Collector Current vs. Collector-Emitter Voltage

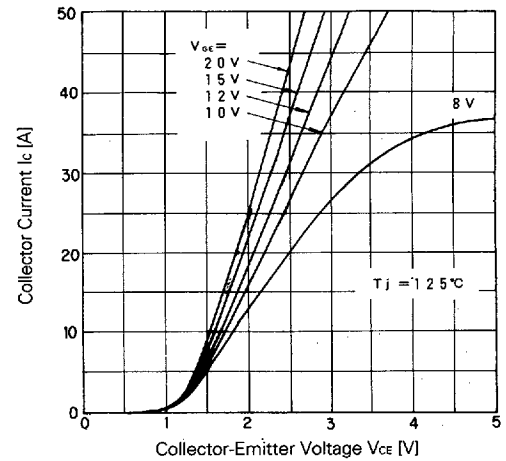

Collector Current vs. Collector-Emitter Voltage

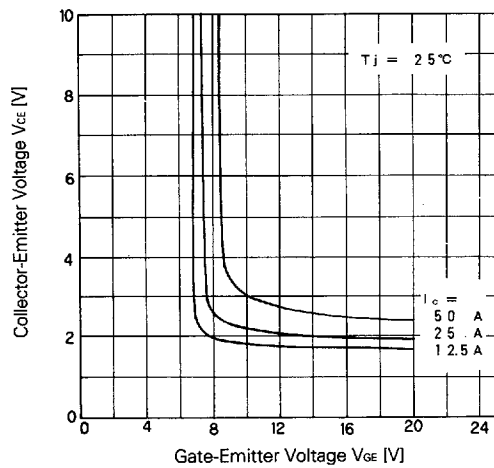

Collector-Emitter Voltage vs. Gate-Emitter Voltage

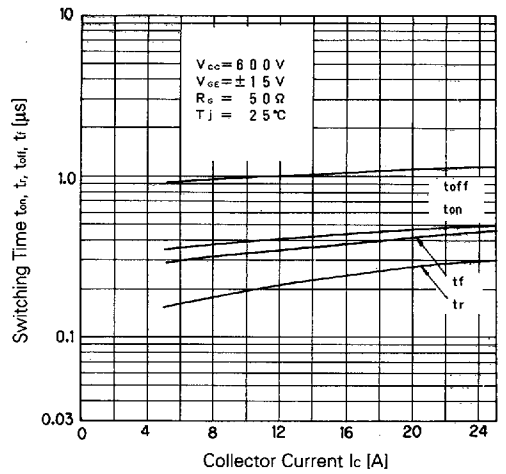

Switching Time

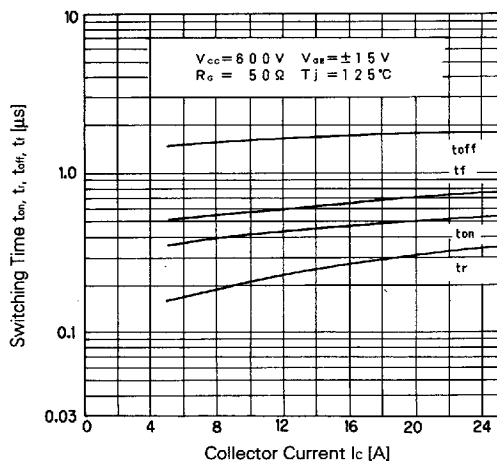

Switching Time

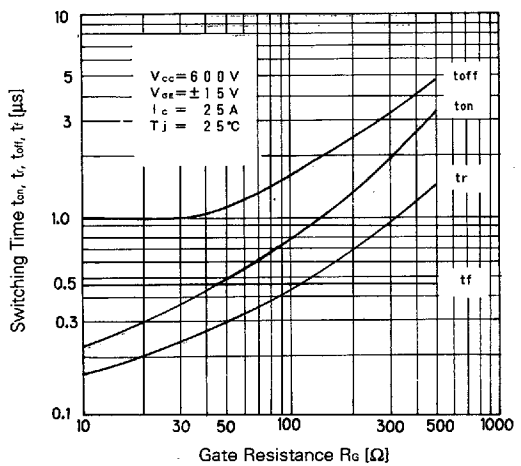

Switching Time-Gate Resistance

[查询"1MBI25FE120"供应商](#)

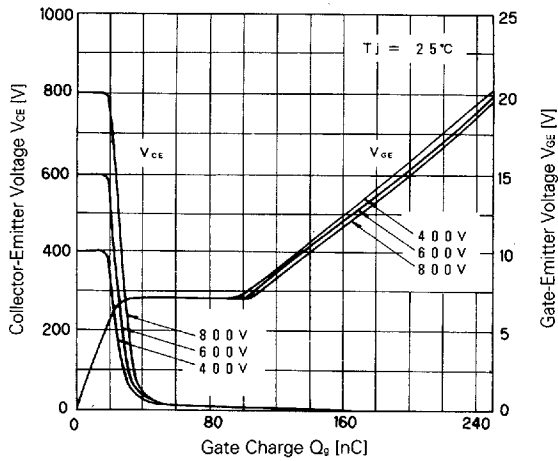

Dynamic Input Characteristic

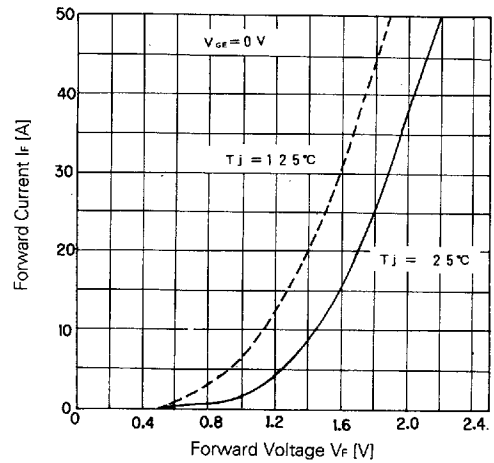

Forward Voltage of Free Wheel Diode

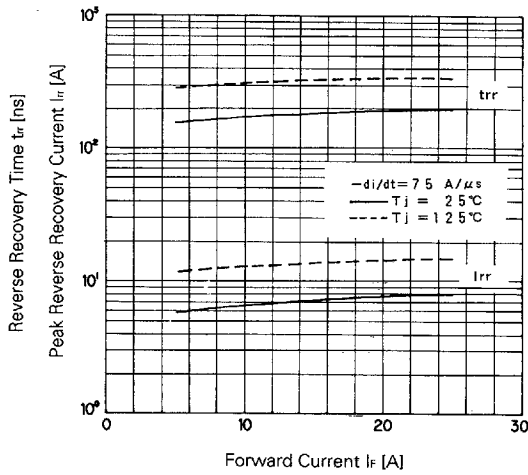

$T_{rr}, I_{rr}-I_f$

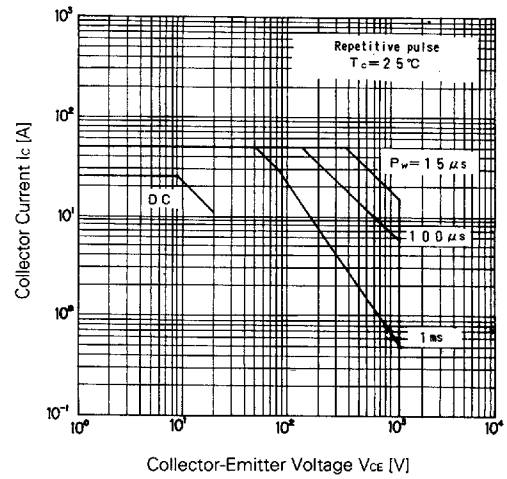

Safe Operating Area

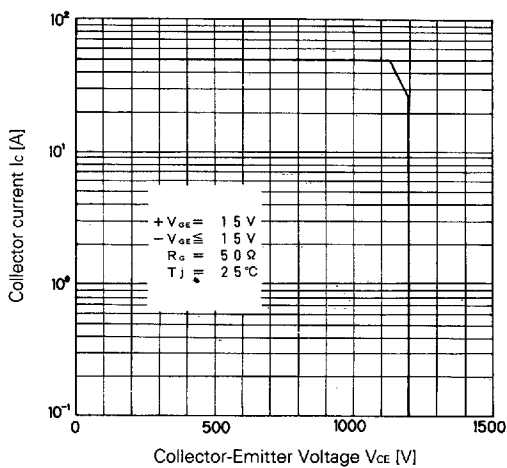

Reverse Biased Safe Operating Area

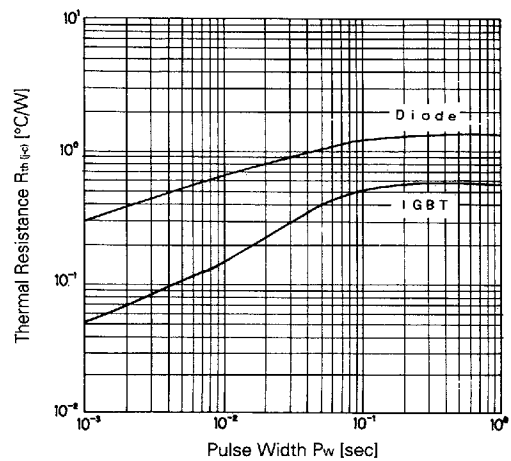

Transient Thermal Resistance