



Zero-Drift, High-Voltage, Programmable Gain INSTRUMENTATION AMPLIFIER

Check for Samples: [PGA280](#)

FEATURES

- **WIDE INPUT RANGE:** $\pm 15.5\text{V}$ at $\pm 18\text{V}$ SUPPLY
- **BINARY GAIN STEPS:** 128V/V to 1/8V/V
- **ADDITIONAL SCALING FACTOR:** 1V/V and $1\frac{3}{8}\text{V/V}$
- **LOW OFFSET VOLTAGE:** $3\mu\text{V}$ at $G = 128$
- **NEAR-ZERO LONG-TERM DRIFT OF OFFSET VOLTAGE**
- **NEAR-ZERO GAIN DRIFT:** $0.5\text{ppm}/^\circ\text{C}$
- **EXCELLENT LINEARITY:** 1.5ppm
- **EXCELLENT CMRR:** 140dB
- **HIGH INPUT IMPEDANCE**
- **VERY LOW 1/f NOISE**
- **DIFFERENTIAL SIGNAL OUTPUT**
- **OVERLOAD DETECTION**
- **INPUT CONFIGURATION SWITCH MATRIX**
- **WIRE BREAK TEST CURRENT**
- **EXPANDABLE SPI™ WITH CHECKSUM**
- **GENERAL-PURPOSE I/O PORT**
- **TSSOP-24 PACKAGE**

APPLICATIONS

- **HIGH-PRECISION SIGNAL INSTRUMENTATION**
- **MULTIPLEXED DATA ACQUISITION**
- **HIGH-VOLTAGE ANALOG INPUT AMPLIFIER**
- **UNIVERSAL INDUSTRIAL ANALOG INPUT**

DESCRIPTION

The PGA280 is a high-precision instrumentation amplifier with digitally-controllable gain and signal integrity test capability. This device offers low offset voltage, near-zero offset and gain drift, excellent linearity, and nearly no 1/f noise with superior common-mode and supply rejection to support high-resolution precision measurement. The 36V supply capability and wide, high-impedance input range comply with requirements for universal signal measurement.

Special circuitry prevents inrush currents from multiplexer (MUX) switching. In addition, the input switch matrix enables easy reconfiguration and system-level diagnostics—overload conditions are indicated.

The configurable general-purpose input/output (GPIO) offers several control and communication features. The SPI can be expanded to communicate with more devices, supporting isolation with only four ISO couplers. The PGA280 is available in a TSSOP-24 package and is specified from -40°C to $+105^\circ\text{C}$.

RELATED PRODUCTS

FEATURES	PRODUCT
23-bit resolution, $\Delta\Sigma$ analog-to-digital converter	ADS1259
Chopper-stabilized instrumentation amplifier, RR I/O, 5V single-supply	INA333
High-precision PGA, $G = 1, 10, 100, 1000$	PGA204
High-precision PGA, JFET Input, $G = 1, 2, 4, 8$	PGA206

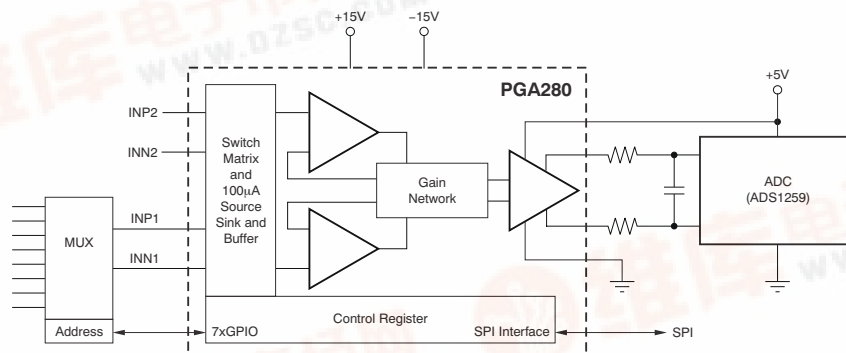

Please be aware that an important notice concerning availability, standard warranty, and use in critical applications of Texas Instruments semiconductor products and disclaimers thereto appears at the end of this data sheet.

SPI is a trademark of Motorola.

All other trademarks are the property of their respective owners.

PRODUCTION DATA information is current as of publication date. Products conform to specifications per the terms of the Texas Instruments standard warranty. Production processing does not necessarily include testing of all parameters.





This integrated circuit can be damaged by ESD. Texas Instruments recommends that all integrated circuits be handled with appropriate precautions. Failure to observe proper handling and installation procedures can cause damage.

ESD damage can range from subtle performance degradation to complete device failure. Precision integrated circuits may be more susceptible to damage because very small parametric changes could cause the device not to meet its published specifications.

PACKAGE INFORMATION⁽¹⁾

PRODUCT	PACKAGE-LEAD	PACKAGE DESIGNATOR	PACKAGE MARKING
PGA280	TSSOP-24	PW	PGA280A

(1) For the most current package and ordering information see the Package Option Addendum at the end of this document, or see the TI web site at www.ti.com.

ABSOLUTE MAXIMUM RATINGS⁽¹⁾

Over operating free-air temperature range, unless otherwise noted.

		PGA280	UNIT
Supply Voltage	VSN to VSP	40	V
	VSON to VSOP, and DGND to DVDD	6	V
Signal Input Terminals, Voltage ⁽²⁾		VSN – 0.5 to VSP + 0.5	V
Signal Input Terminals, Current ⁽²⁾		±10	mA
Output Short-Circuit ⁽³⁾		Continuous	
Operating Temperature		–55 to +140	°C
Storage Temperature		–65 to +150	°C
Junction Temperature		+150	°C
ESD Ratings	Human Body Model (HBM)	2000	V

- (1) Stresses above these ratings may cause permanent damage. Exposure to absolute maximum conditions for extended periods may degrade device reliability. These are stress ratings only, and functional operation of the device at these or any other conditions beyond those specified is not implied.
- (2) Terminals are diode-clamped to the power-supply (VON and VOP) rails. Signals that can swing more than 0.5V beyond the supply rails must be current-limited.
- (3) Short-circuit to VSON or VSOP, respectively, DGND or DVDD.

ELECTRICAL CHARACTERISTICS

Boldface limits apply over the specified temperature range, $T_A = -40^{\circ}\text{C}$ to $+105^{\circ}\text{C}$.

At $T_A = +25^{\circ}\text{C}$, $V_{SP} = +15\text{V}$, $V_{SN} = -15\text{V}$, $V_{SON} = 0\text{V}$, $V_{SOP} = 5\text{V}$, $DV_{DD} = +3\text{V}$, $DG_{ND} = 0\text{V}$, $R_L = 2.5\text{k}\Omega$ to $VSOP/2 = VO_{CM}$, $G = 1\text{V/V}$, using internal clock, BUF inactive, $V_{CM} = 0\text{V}$, and differential input and output, unless otherwise noted.

PARAMETER	CONDITIONS	PGA280			UNIT
		MIN	TYP	MAX	
INPUT					
Offset Voltage, RTI ⁽¹⁾	V_{OS} Gain = 1V/V, 1.375V/V		±50	±250	μV
	Gain = 128V/V		±3	±15	μV
vs Temperature ⁽²⁾	Gain = 1V/V		±0.2	±0.6	μV/°C
	Gain = 128V/V		±0.03	±0.17	μV/°C
vs Power Supply, RTI	PSR VSP – VSN = 10 and 36V, Gain = 1V/V, 128V/V		±0.3	±3	μV/V
vs External Clock, RTI ⁽³⁾	dV_{OS}/df 0.8MHz to 1.2MHz, Gain = 1V/V		±0.05		μV/kHz
	0.8MHz to 1.2MHz, Gain = 128V/V		±0.001		μV/kHz
Long-Term Stability ⁽⁴⁾	Gain=128		3.5		nV/month
Input Impedance	Single-ended and Differential		>1		GΩ
Input Capacitance, IN1 / IN2	Single-ended		12 / 8		pF
Input Voltage Range	Gain = 1V/V, Gain = 128V/V	(VSN) + 2.5		(VSP) – 2.5	V
Common-Mode Rejection, RTI	CMR Gain = 1V/V		±0.3	±3	μV/V
	Gain = 128V/V		±0.08	±0.8	μV/V
Over Temperature	Gain = 128V/V		±0.1	±1.5	μV/V
SINGLE-ENDED OUTPUT CONNECTION					
Offset Voltage, RTI, SE Out	V_{OS} Gain = 1V/V, 1.375V/V, SE		±120		μV
	Gain = 128V/V, SE		±3		μV
vs Temperature, SE Out	Gain = 1V/V, SE		0.6		μV/°C
	Gain = 64V/V, SE		0.05		μV/°C
INPUT BIAS CURRENT ⁽³⁾					
Bias Current	I_B Gain = 1V/V		±0.3	±1	nA
	Gain = 128V/V		±0.8	±2	nA
Over Temperature	I_B Gain = 1V/V, Gain = 128V/V		±0.6	±2	nA
Offset Current	I_{OS} Gain = 1V/V, Gain = 128V/V		±0.1	±0.5	nA
Over Temperature	I_{OS} Gain = 1V/V, Gain = 128V/V		±0.9	±2	nA
NOISE					
Voltage Noise, RTI; Target	e_{NI}				
f = 0.01Hz to 10Hz	$R_S = 0\Omega, G = 128$		420		nV _{PP}
f = 1kHz	$R_S = 0\Omega, G = 128$		22		nV/√Hz
f = 0.01Hz to 10Hz	$R_S = 0\Omega, G = 1$		4.5		μV _{PP}
f = 1kHz	$R_S = 0\Omega, G = 1$		240		nV/√Hz
Current Noise, RTI	I_N				
f = 0.01Hz to 10Hz	$R_S = 10\text{M}\Omega, G = 128$		1.7		pA _{PP}
f = 1kHz	$R_S = 10\text{M}\Omega, G = 128$		90		fA/√Hz

(1) RTI: Referred to input.

(2) Specified by design; not production tested.

(3) See [Application Information](#) section and typical characteristic graphs.

(4) 300-hour life test at $+150^{\circ}\text{C}$ demonstrated randomly distributed variation in the range of measurement limits.

ELECTRICAL CHARACTERISTICS (continued)

Boldface limits apply over the specified temperature range, $T_A = -40^\circ\text{C}$ to $+105^\circ\text{C}$.

At $T_A = +25^\circ\text{C}$, $V_{SP} = +15\text{V}$, $V_{SN} = -15\text{V}$, $V_{SON} = 0\text{V}$, $V_{SOP} = 5\text{V}$, $DVDD = +3\text{V}$, $DGND = 0\text{V}$, $R_L = 2.5\text{k}\Omega$ to $V_{SOP}/2 = \text{VOCM}$, $G = 1\text{V}/\text{V}$, using internal clock, BUF inactive, $V_{CM} = 0\text{V}$, and differential input and output, unless otherwise noted.

PARAMETER	CONDITIONS	PGA280			UNIT
		MIN	TYP	MAX	
GAIN	Output Swing: $\pm 4.5\text{V}^{(5)}$				
Range of Input Gain			$\frac{1}{8}$ to 128		V/V
Range of Output Gain: 1V/V and 1%			1 and 1%		V/V
Gain Error, All Binary Steps vs Temperature⁽⁶⁾ (7)	All Gains No Load, All Gains Except G = 128V/V No Load, G = 128V/V		± 0.03 -0.5 -1	± 0.15 ± 2 ± 3	% ppm/°C ppm/°C
Gain Step Matching ⁽⁸⁾ (Gain to gain)	No Load, All Gains	See Typical Characteristics			
Nonlinearity Over Temperature⁽⁶⁾	No Load, All Gains ⁽⁹⁾ No Load, All Gains		1.5 3	10	ppm ppm
OUTPUT					
Voltage Output Swing from Rail⁽⁸⁾	V_{SOP} = 5V, Load Current 2mA V_{SOP} = 2.7V, Load Current 1.5mA		40	100	mV
Capacitive Load Drive			500		pF
Short-Circuit Current	I_{SC} To $V_{SOP}/2$, Gain = 1.375V/V	7	15	25	mA
Output Resistance	Each output VOP and VON		200		m Ω
VOLTAGE RANGE FOR VO_{CM}	V_{SP}-2V > VO_{CM}	(V_{SON}) + 0.1		(V_{SOP}) - 0.1	V
Bias Current into VO _{CM}	I_B		3	100	nA
VO _{CM} Input Resistance			1		G Ω
INTERNAL OSCILLATOR					
Frequency of Internal Clock ⁽⁶⁾ (8)		0.8	1	1.2	MHz
Ext. Oscillator Frequency Range		0.8	1	1.2	MHz
FREQUENCY RESPONSE					
Gain Bandwidth Product ⁽⁸⁾	GBP $G > 4$		6		MHz
Slew Rate ⁽⁸⁾ , 4V _{PP} Output Step	SR $G = 1, C_L = 100\text{pF}$, BUF On $G = 8, C_L = 100\text{pF}$ $G = 128, C_L = 100\text{pF}$		1 2 1		V/ μs V/ μs V/ μs
Settling Time ⁽⁸⁾	t_S				
0.01%	$G = 8, V_O = 8V_{PP}$ Step		20		μs
0.001%	$G = 8, V_O = 8V_{PP}$ Step		30		μs
0.01%	$G = 128, V_O = 8V_{PP}$ Step		40		μs
0.001%	$G = 128, V_O = 8V_{PP}$ Step		40		μs
Overload Recovery, Input ⁽⁸⁾	0.5V Over Supply, $G = \frac{1}{8}$ to 128		8		μs
Overload Recovery, Output ⁽⁸⁾	$\pm 5.5V_p$ Input, $G = 1\text{V}/\text{V}$		6		μs
INPUT MULTIPLEXER (Two-Channel)					
Crosstalk, INP1 to INP2	At dc; Gain = 128V/V		< -130		dB
Series-Resistance ⁽⁸⁾ —see Figure 44			600		Ω
Switch On-Resistance ⁽⁸⁾			450		Ω
Current Source and Sink ⁽⁸⁾	To GND	70	95	125	μA
INPUT CURRENT BUFFER (BUF)					
Offset Voltage ⁽⁸⁾	V_{OS} Buffer Active		15		mV

(5) Gains smaller than $\frac{1}{2}$ are measured with smaller output swing.

(6) Specified by design; not production tested.

(7) See [Figure 10](#) for typical gain error drift of various gain settings.

(8) See [Application Information](#) section and typical characteristic graphs.

(9) Only $G = 1$ is production tested.

ELECTRICAL CHARACTERISTICS (continued)

Boldface limits apply over the specified temperature range, $T_A = -40^{\circ}\text{C}$ to $+105^{\circ}\text{C}$.

At $T_A = +25^{\circ}\text{C}$, $V_{SP} = +15\text{V}$, $V_{SN} = -15\text{V}$, $V_{SON} = 0\text{V}$, $V_{SOP} = 5\text{V}$, $DVDD = +3\text{V}$, $DGND = 0\text{V}$, $R_L = 2.5\text{k}\Omega$ to $V_{SOP}/2 = VO_{CM}$, $G = 1\text{V}/\text{V}$, using internal clock, BUF inactive, $V_{CM} = 0\text{V}$, and differential input and output, unless otherwise noted.

PARAMETER	CONDITIONS	PGA280			UNIT
		MIN	TYP	MAX	
DIGITAL I/O	Supply: 2.7V to 5.5V				
Input (Logic Low Threshold)		0		(DVDD)x0.2	V
Input (Logic High Threshold)		0.8x(DVDD)		DVDD	V
Output (Logic Low)	$I_{OUT} = 4\text{mA}$, Sink			0.7	V
Output (Logic High)	$I_{OUT} = 2\text{mA}$, Source	DVDD – 0.5			V
SCLK, Frequency				10	MHz
POWER SUPPLY: Input Stage (VSN – VSP)					
Specified Voltage Range		10		36	V
Operating Voltage Range			10 to 38		V
Quiescent Current (VSP) I_q			2.4	3	mA
Quiescent Current (VSN) I_q			2.1	3	mA
POWER SUPPLY: Output Stage (VSOP – VSON)					
Specified Voltage Range	$V_{SP} - 1.5\text{V} \geq V_{SOP}$	2.7		5.5	V
Voltage Range for VSOP, Upper Limit	$(V_{SP} - 2\text{V}) > VO_{CM}$, $(V_{SP} - 5\text{V}) > V_{SON}$		(VSP)		V
Voltage Range for VSON	$(V_{SP} - 2\text{V}) > VO_{CM}$, $V_{SP} \geq V_{SOP}$		(VSN) to (VSP) – 5		V
Quiescent Current I_q	VSOP		0.75	1	mA
POWER SUPPLY: Digital (DVDD – DGND)					
Specified Voltage Range		2.7		5.5	V
Voltage Range for DVDD, Upper Limit			(VSP) – 1		V
Voltage Range for DGND, Lower Limit			(VSN)		V
Quiescent Current⁽¹⁰⁾ I_q	Static Condition, No External Load, DVDD = 3V		0.07	0.13	mA
TEMPERATURE RANGE					
Specified Range		–40		+105	$^{\circ}\text{C}$
Operating Range		–55		+140	$^{\circ}\text{C}$
Thermal Resistance θ_{JA}					
SSOP	High-K Board, JESD51		80		$^{\circ}\text{C}/\text{W}$

(10) See [Application Information](#) section and typical characteristic graphs.

PIN CONFIGURATION

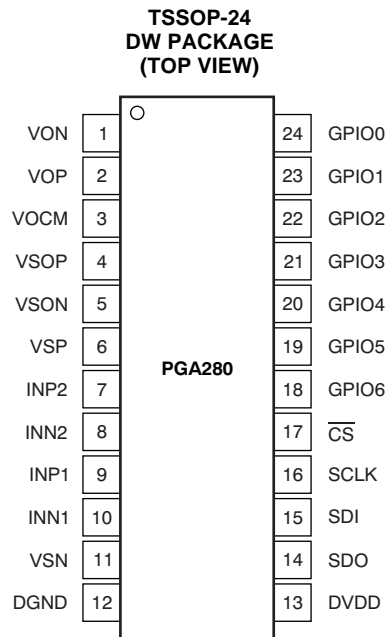

PIN DESCRIPTIONS

PIN NO.	NAME	DESCRIPTION	PIN NO.	NAME	DESCRIPTION
1	VON	Inverting signal output	13	DVDD	Digital supply
2	VOP	Noninverting signal output	14	SDO	SPI slave data output
3	VOCM	Input, output common-mode voltage	15	SDI	SPI slave data input
4	VSOP	Positive supply for output	16	SCLK	SPI clock input
5	VSON	Negative supply for output, AGND	17	\overline{CS}	SPI chip select input; active low
6	VSP	Positive high-voltage supply	18	GPIO6	GPIO 6, SYNC (in), OSC (out), $\overline{ECS6}$
7	INP2	AUX input, noninverting	19	GPIO5	GPIO 5, BUFA (out), $\overline{ECS5}$
8	INN2	AUX input, inverting	20	GPIO4	GPIO 4, BUFT (in), $\overline{ECS4}$
9	INP1	Signal input, noninverting	21	GPIO3	GPIO 3, EF (out), $\overline{ECS3}$
10	INN1	Signal input, inverting	22	GPIO2	GPIO 2, $\overline{ECS2}$, MUX2
11	VSN	Negative high-voltage supply	23	GPIO1	GPIO 1, $\overline{ECS1}$, MUX1
12	DGND	Digital ground	24	GPIO0	GPIO 0, $\overline{ECS0}$, MUX0

TYPICAL CHARACTERISTICS

At $T_A = +25^\circ\text{C}$, $V_{SP} = +15\text{V}$, $V_{SN} = -15\text{V}$, $V_{SON} = 0\text{V}$, $V_{SOP} = 5\text{V}$, $DV_{DD} = +3\text{V}$, $DGND = 0\text{V}$, $R_L = 2.5\text{k}\Omega$ to $V_{SOP}/2 = V_{OCM}$, $G = 1\text{V/V}$, using internal clock, BUF inactive, $V_{CM} = 0\text{V}$, and differential input and output, unless otherwise noted.

OFFSET VOLTAGE PRODUCTION DISTRIBUTION (G = 128)

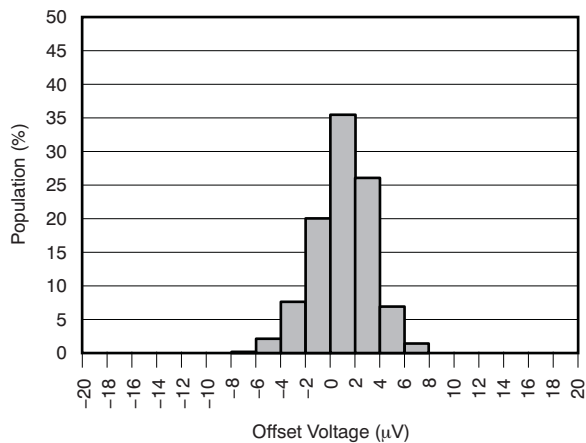

Figure 1.

OFFSET VOLTAGE PRODUCTION DISTRIBUTION (G = 1)

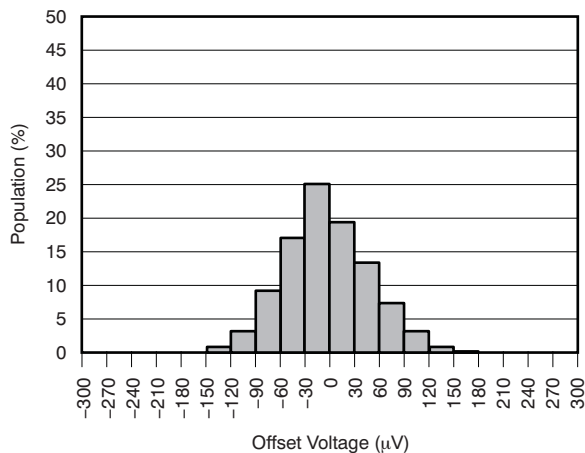

Figure 2.

OFFSET VOLTAGE DRIFT DISTRIBUTION (G = 128)

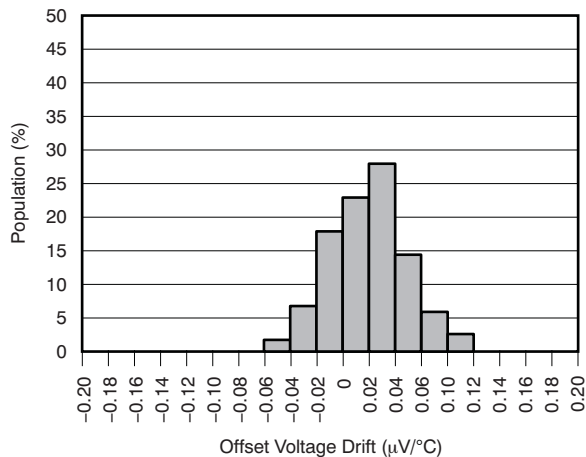

Figure 3.

OFFSET VOLTAGE DRIFT DISTRIBUTION (G = 1)

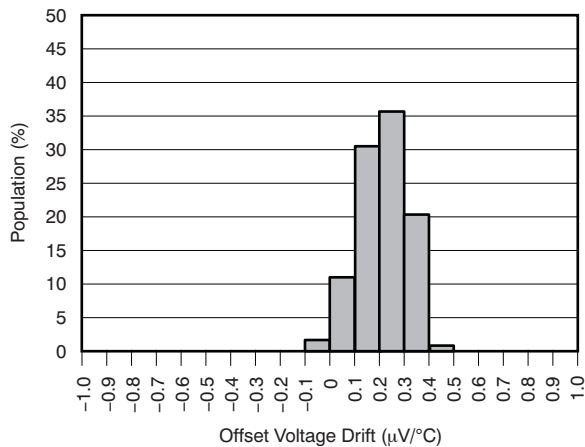

Figure 4.

TYPICAL CHARACTERISTICS (continued)

At $T_A = +25^\circ\text{C}$, $V_{SP} = +15\text{V}$, $V_{SN} = -15\text{V}$, $V_{SON} = 0\text{V}$, $V_{SOP} = 5\text{V}$, $DV_{DD} = +3\text{V}$, $DG_{ND} = 0\text{V}$, $R_L = 2.5\text{k}\Omega$ to $V_{SOP}/2 = \text{VO}_{CM}$, $G = 1\text{V/V}$, using internal clock, BUF inactive, $V_{CM} = 0\text{V}$, and differential input and output, unless otherwise noted.

COMMON-MODE REJECTION DISTRIBUTION (G = 128)

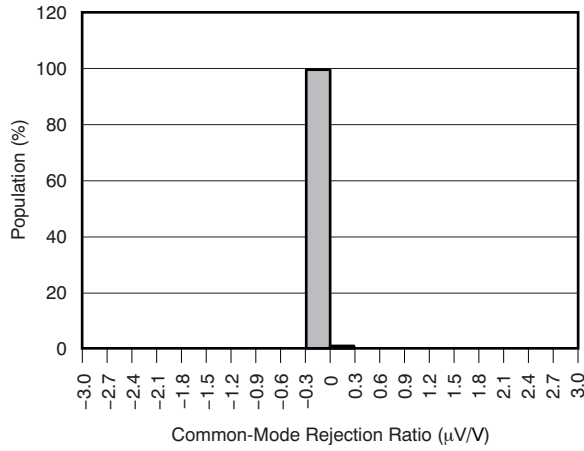

Figure 5.

COMMON-MODE REJECTION DISTRIBUTION (G = 1)

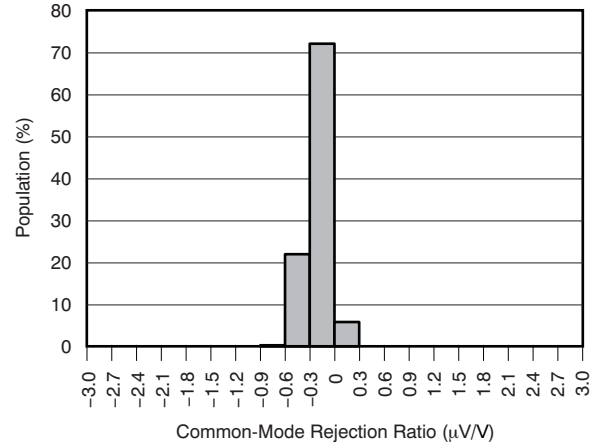

Figure 6.

GAIN ERROR DISTRIBUTION (G = 128)

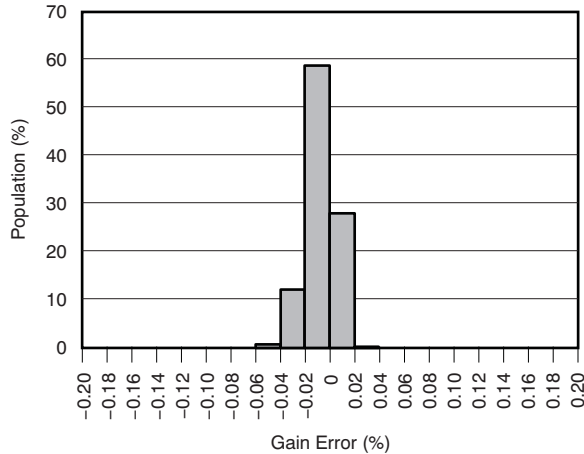

Figure 7.

GAIN ERROR DISTRIBUTION (G = 1)

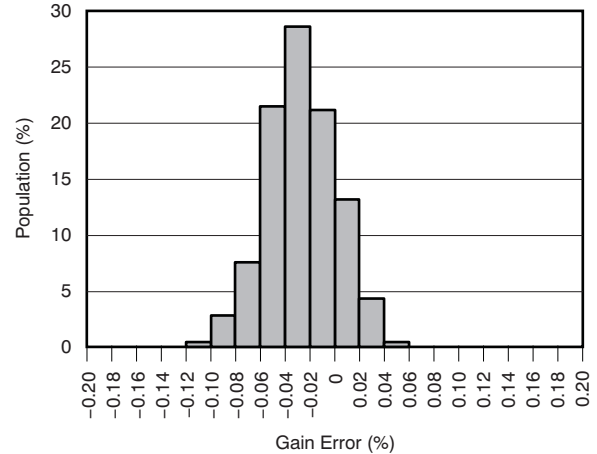

Figure 8.

TYPICAL CHARACTERISTICS (continued)

At $T_A = +25^\circ\text{C}$, $V_{SP} = +15\text{V}$, $V_{SN} = -15\text{V}$, $V_{SON} = 0\text{V}$, $V_{SOP} = 5\text{V}$, $DV_{DD} = +3\text{V}$, $DGND = 0\text{V}$, $R_L = 2.5\text{k}\Omega$ to $V_{SOP}/2 = VO_{CM}$, $G = 1\text{V}/\text{V}$, using internal clock, BUF inactive, $V_{CM} = 0\text{V}$, and differential input and output, unless otherwise noted.

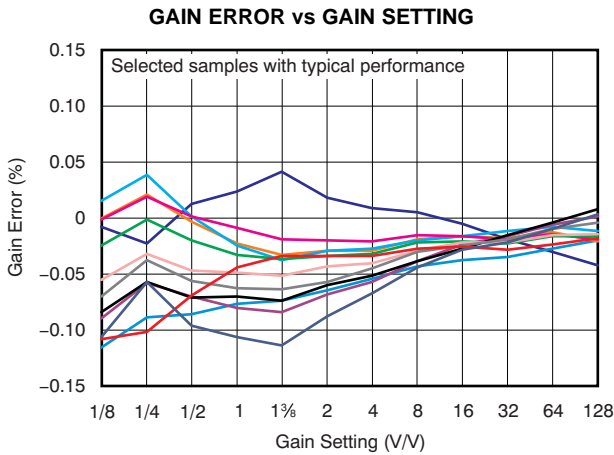

Figure 9.

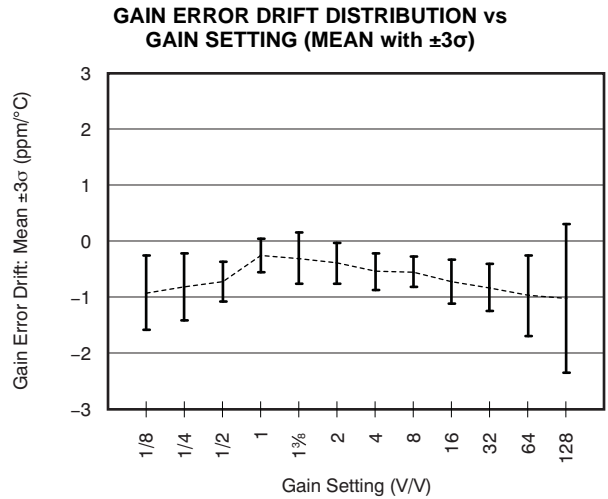

Figure 10.

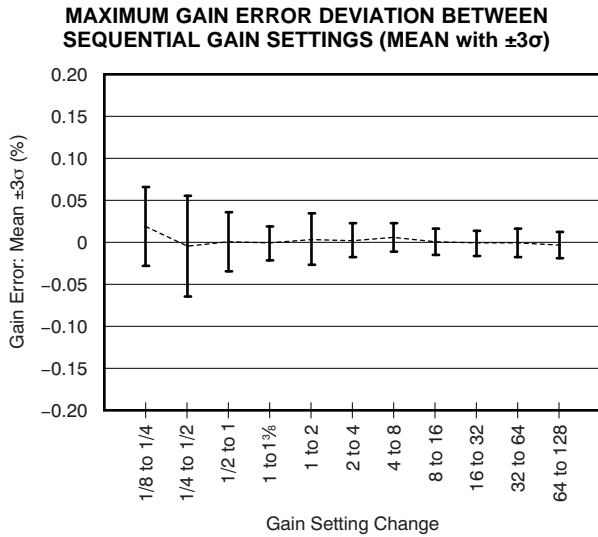

Figure 11.

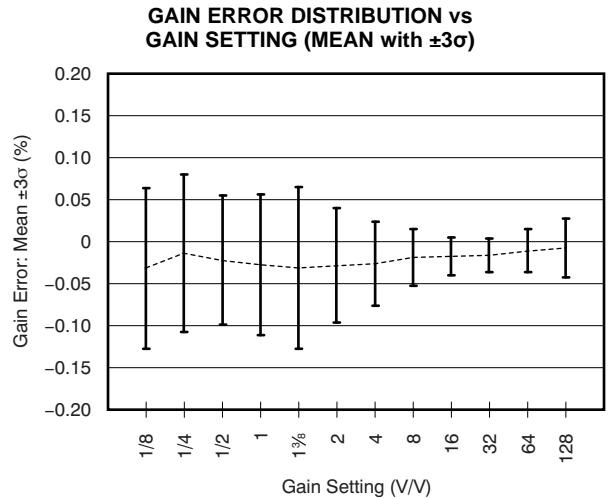

Figure 12.

TYPICAL CHARACTERISTICS (continued)

At $T_A = +25^\circ\text{C}$, $V_{SP} = +15\text{V}$, $V_{SN} = -15\text{V}$, $V_{SON} = 0\text{V}$, $V_{SOP} = 5\text{V}$, $DV_{DD} = +3\text{V}$, $DG_{ND} = 0\text{V}$, $R_L = 2.5\text{k}\Omega$ to $V_{SOP}/2 = V_{OCM}$, $G = 1\text{V/V}$, using internal clock, BUF inactive, $V_{CM} = 0\text{V}$, and differential input and output, unless otherwise noted.

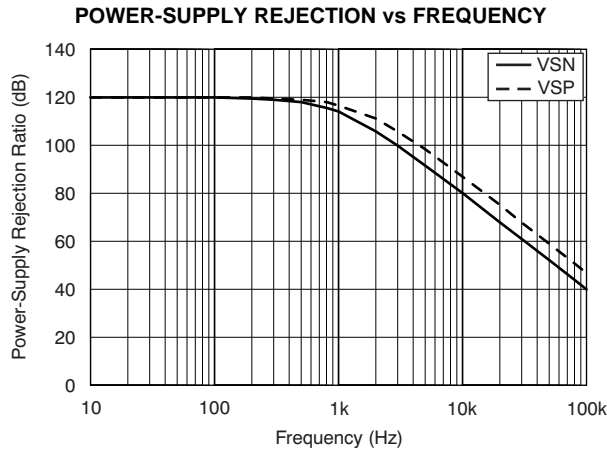

Figure 13.

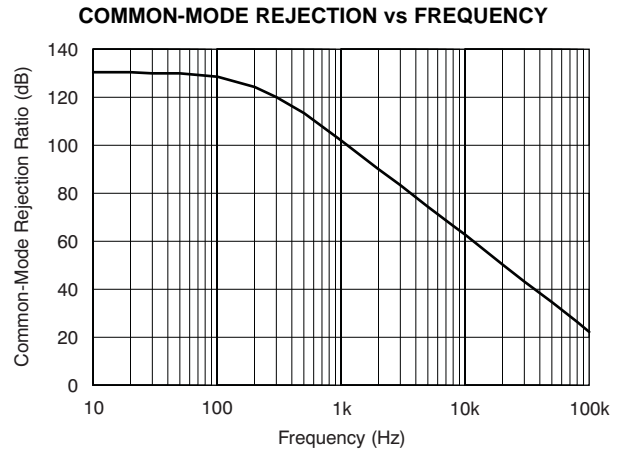

Figure 14.

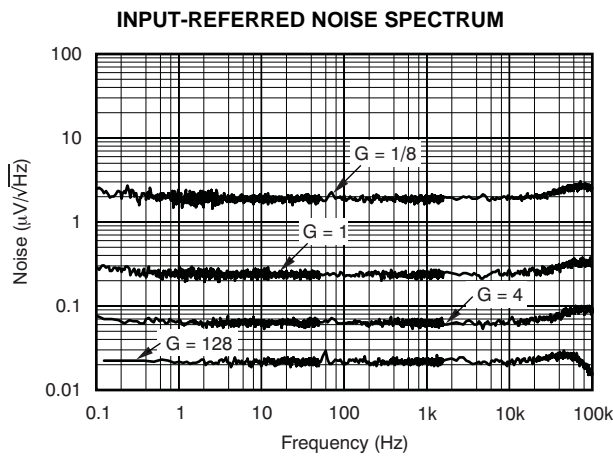

Figure 15.

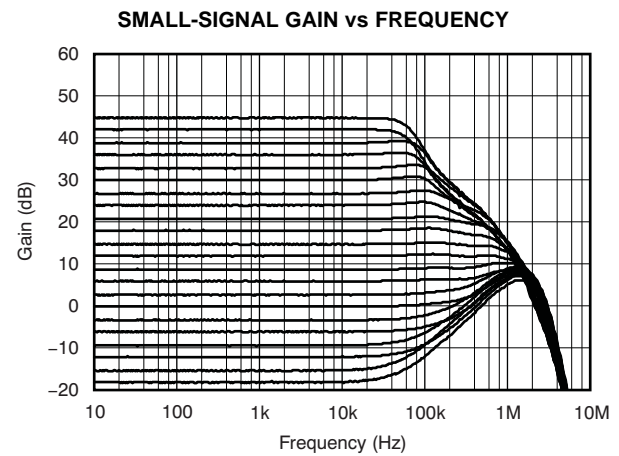

Figure 16.

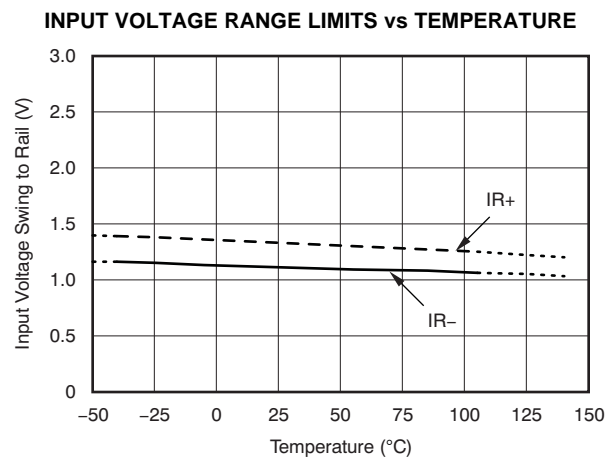

Figure 17.

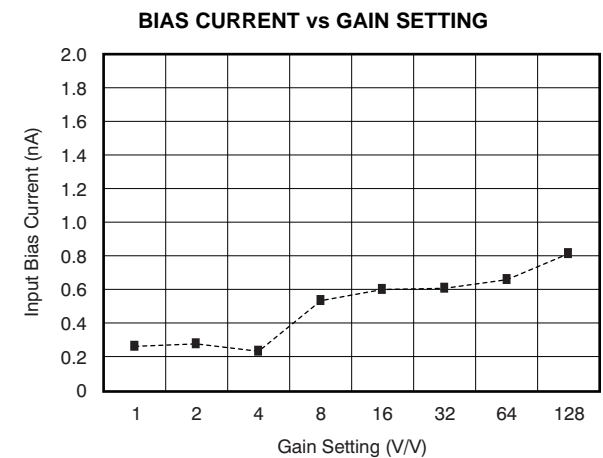

Figure 18.

TYPICAL CHARACTERISTICS (continued)

At $T_A = +25^\circ\text{C}$, $V_{SP} = +15\text{V}$, $V_{SN} = -15\text{V}$, $V_{SON} = 0\text{V}$, $V_{SOP} = 5\text{V}$, $DV_{DD} = +3\text{V}$, $DG_{ND} = 0\text{V}$, $R_L = 2.5\text{k}\Omega$ to $V_{SOP}/2 = \text{VO}_{CM}$, $G = 1\text{V/V}$, using internal clock, BUF inactive, $V_{CM} = 0\text{V}$, and differential input and output, unless otherwise noted.

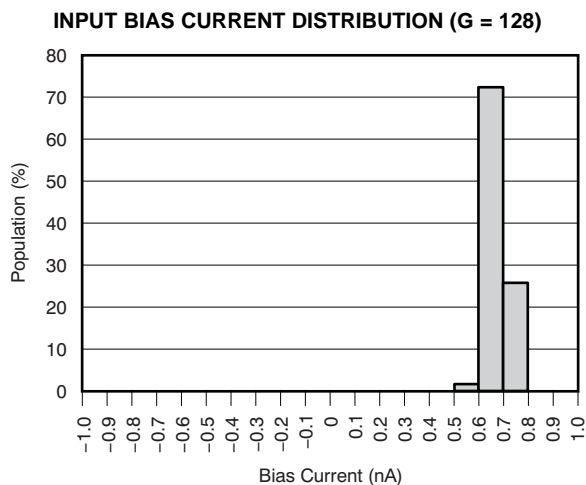

Figure 19.

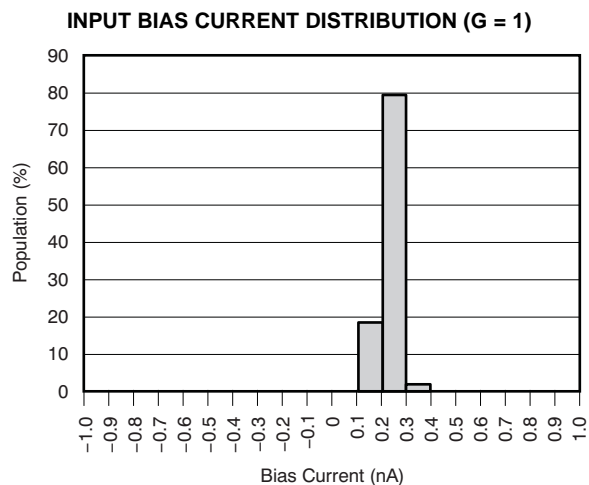

Figure 20.

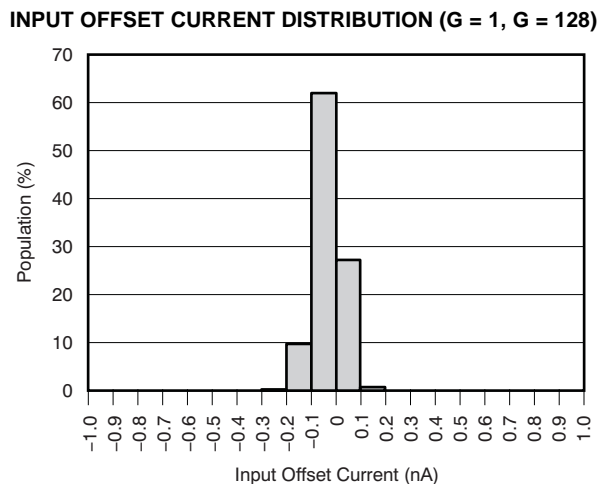

Figure 21.

INPUT BIAS CURRENT AND INPUT OFFSET CURRENT vs TEMPERATURE

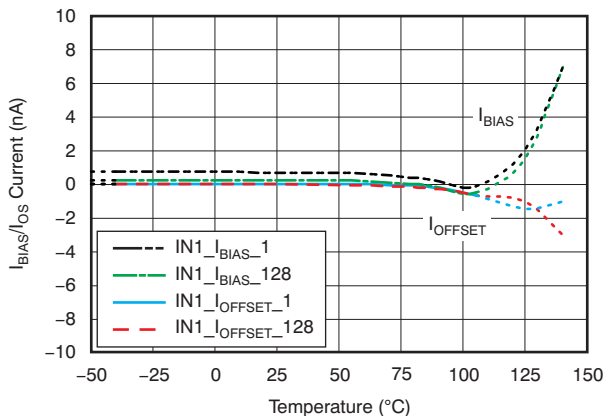

Figure 22.

TYPICAL CHARACTERISTICS (continued)

At $T_A = +25^\circ\text{C}$, $V_{SP} = +15\text{V}$, $V_{SN} = -15\text{V}$, $V_{SON} = 0\text{V}$, $V_{SOP} = 5\text{V}$, $DV_{DD} = +3\text{V}$, $DG_{ND} = 0\text{V}$, $R_L = 2.5\text{k}\Omega$ to $V_{SOP}/2 = \text{VOCM}$, $G = 1\text{V/V}$, using internal clock, BUF inactive, $V_{CM} = 0\text{V}$, and differential input and output, unless otherwise noted.

QUIESCENT CURRENT FROM SUPPLIES (VSP AND VSOP) vs TEMPERATURE

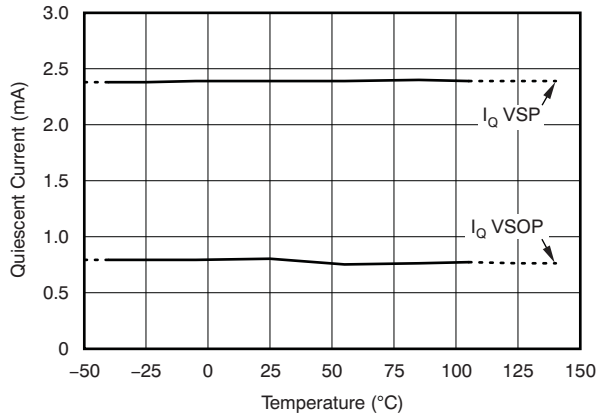

Figure 23.

DIGITAL SUPPLY CURRENT WITH AND WITHOUT SPI COMMUNICATION vs TEMPERATURE

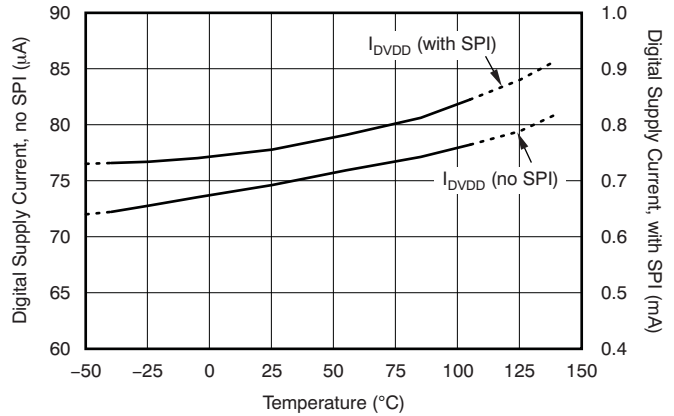

Figure 24.

GAIN NONLINEARITY WITH END-POINT CALIBRATION (G = 1)

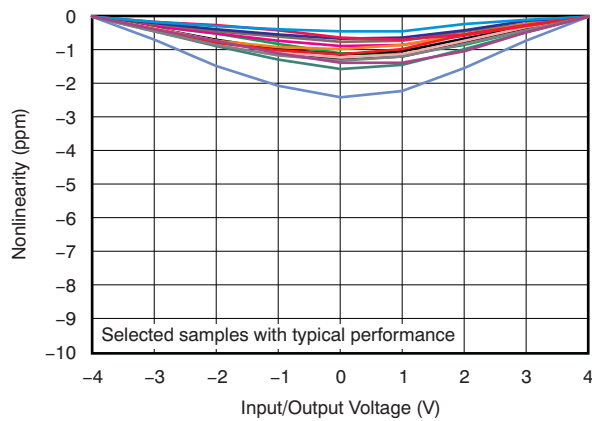

Figure 25.

GAIN NONLINEARITY vs TEMPERATURE

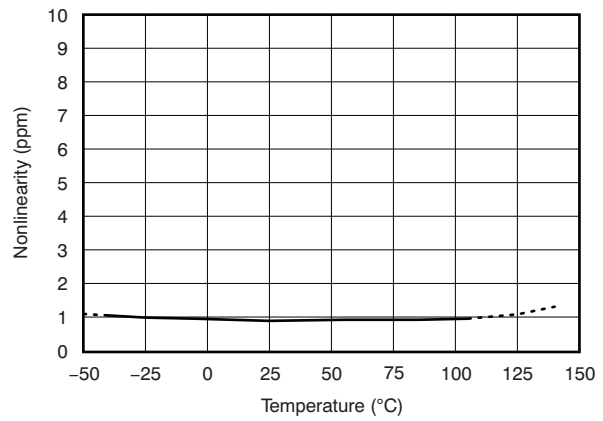

Figure 26.

TYPICAL CHARACTERISTICS (continued)

At $T_A = +25^\circ\text{C}$, $V_{SP} = +15\text{V}$, $V_{SN} = -15\text{V}$, $V_{SON} = 0\text{V}$, $V_{SOP} = 5\text{V}$, $DV_{DD} = +3\text{V}$, $DG_{ND} = 0\text{V}$, $R_L = 2.5\text{k}\Omega$ to $V_{SOP}/2 = \text{VOCM}$, $G = 1\text{V/V}$, using internal clock, BUF inactive, $V_{CM} = 0\text{V}$, and differential input and output, unless otherwise noted.

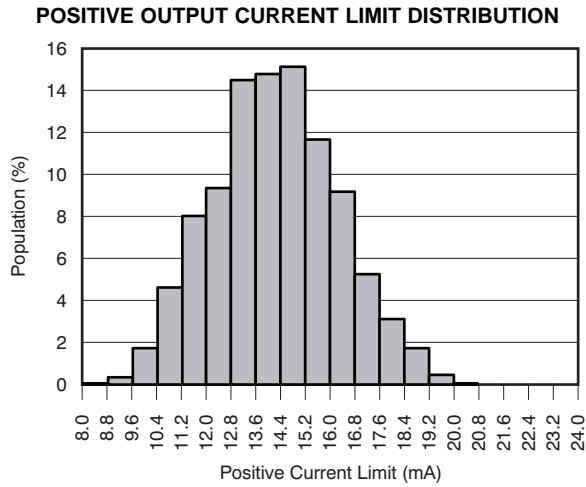

Figure 27.

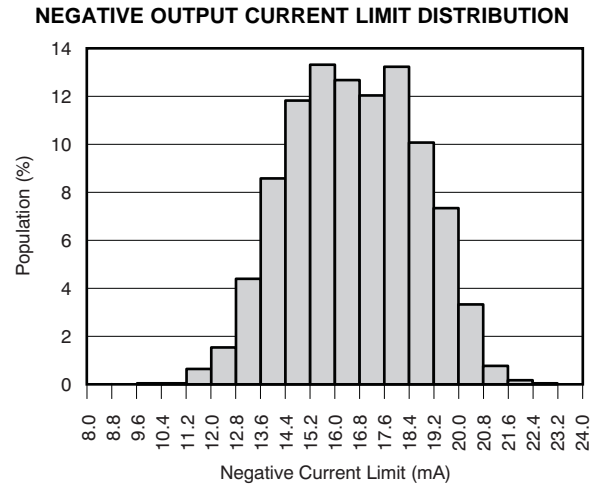

Figure 28.

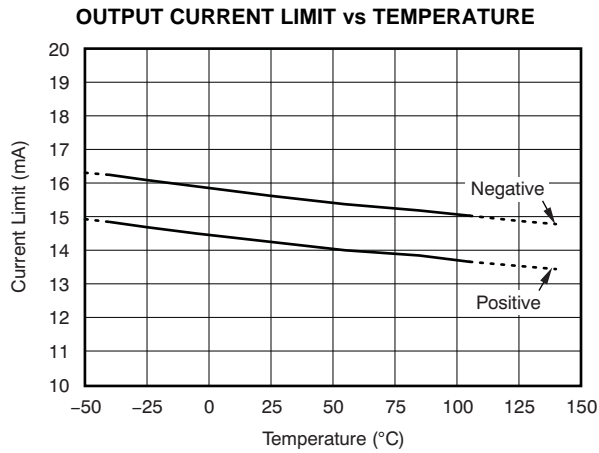

Figure 29.

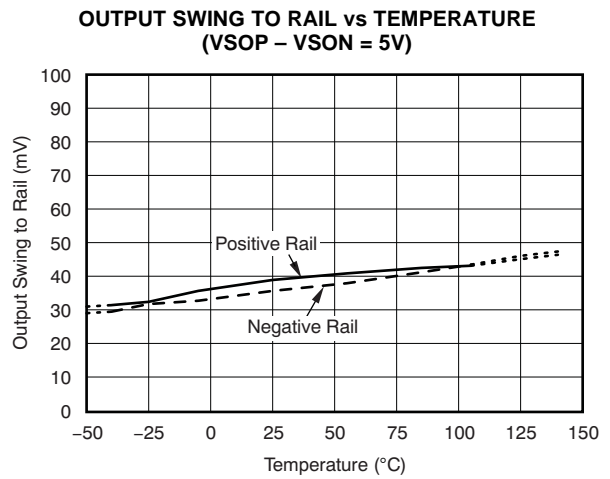

Figure 30.

TYPICAL CHARACTERISTICS (continued)

At $T_A = +25^\circ\text{C}$, $V_{SP} = +15\text{V}$, $V_{SN} = -15\text{V}$, $V_{SON} = 0\text{V}$, $V_{SOP} = 5\text{V}$, $DV_{DD} = +3\text{V}$, $DG_{ND} = 0\text{V}$, $R_L = 2.5\text{k}\Omega$ to $V_{SOP}/2 = \text{VOCM}$, $G = 1\text{V/V}$, using internal clock, BUF inactive, $V_{CM} = 0\text{V}$, and differential input and output, unless otherwise noted.

SWITCH-ON RESISTANCE AND SERIES INPUT RESISTANCE vs COMMON-MODE VOLTAGE AT VARIOUS SUPPLY VOLTAGES

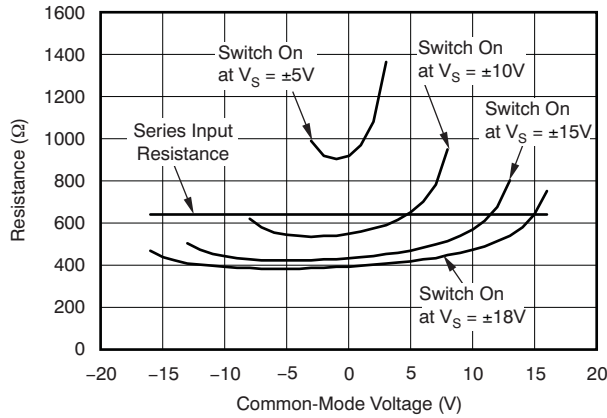

Figure 31.

SWITCH-ON RESISTANCE AND SERIES INPUT RESISTANCE vs TEMPERATURE

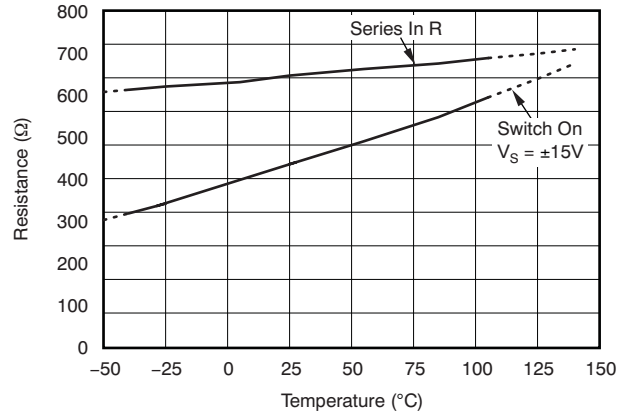

Figure 32.

WIRE BREAK CURRENT DISTRIBUTION

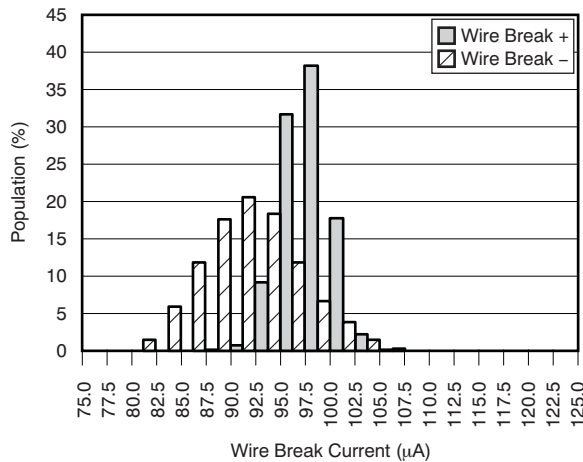

Figure 33.

WIRE BREAK CURRENT MAGNITUDE vs TEMPERATURE

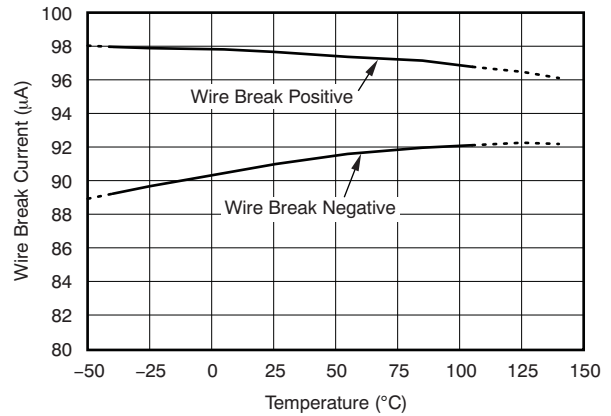

Figure 34.

TYPICAL CHARACTERISTICS (continued)

At $T_A = +25^\circ\text{C}$, $V_{SP} = +15\text{V}$, $V_{SN} = -15\text{V}$, $V_{SON} = 0\text{V}$, $V_{SOP} = 5\text{V}$, $DV_{DD} = +3\text{V}$, $DG_{ND} = 0\text{V}$, $R_L = 2.5\text{k}\Omega$ to $V_{SOP}/2 = \text{VOCM}$, $G = 1\text{V/V}$, using internal clock, BUF inactive, $V_{CM} = 0\text{V}$, and differential input and output, unless otherwise noted.

INFLUENCE OF EXTERNAL CLOCK FREQUENCY TO VOS PERFORMANCE (G = 128)

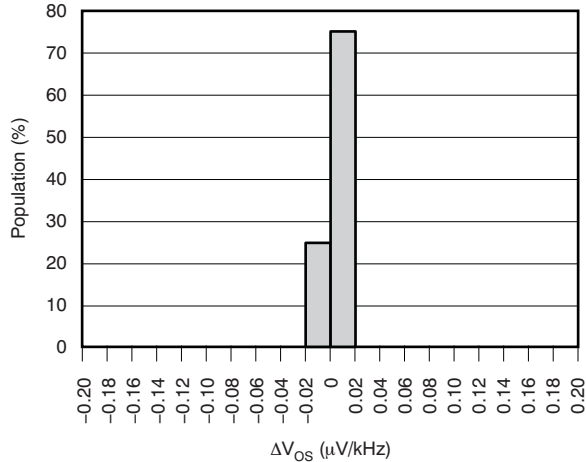

Figure 35.

INFLUENCE OF EXTERNAL CLOCK FREQUENCY TO VOS PERFORMANCE (G = 1)

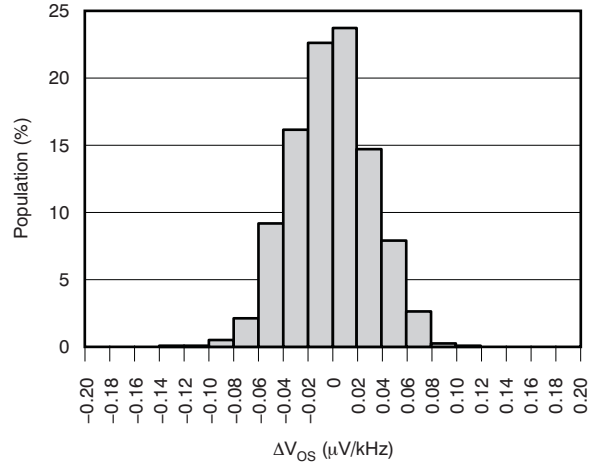

Figure 36.

STEP RESPONSE (G = 128)

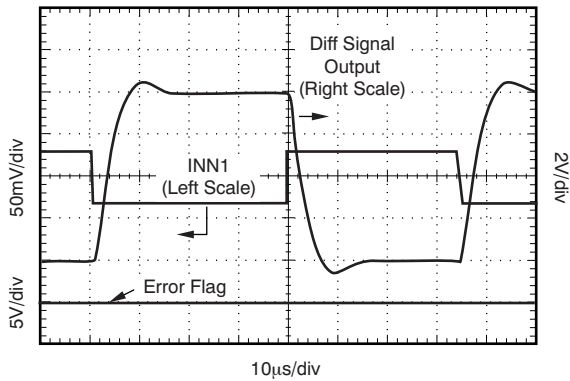

Figure 37.

STEP RESPONSE (G = 8)

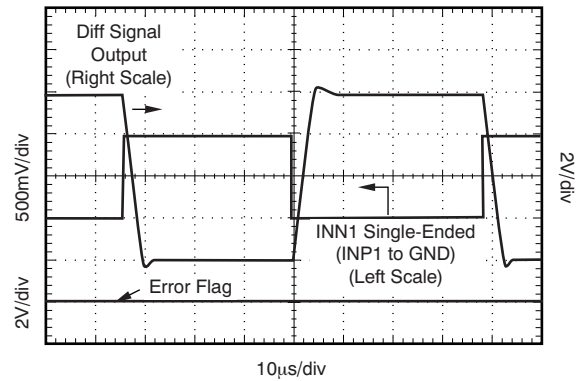

Figure 38.

STEP RESPONSE (G = 1)

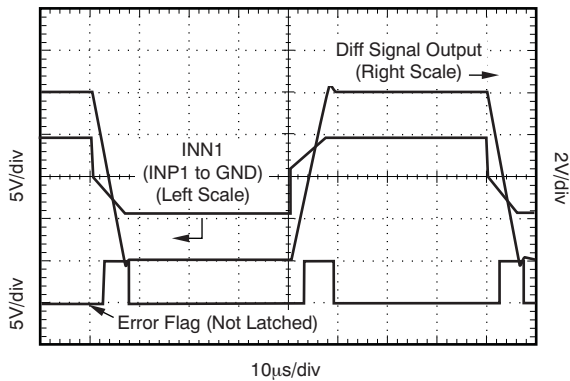

Figure 39.

OUTPUT OVERLOAD RECOVERY

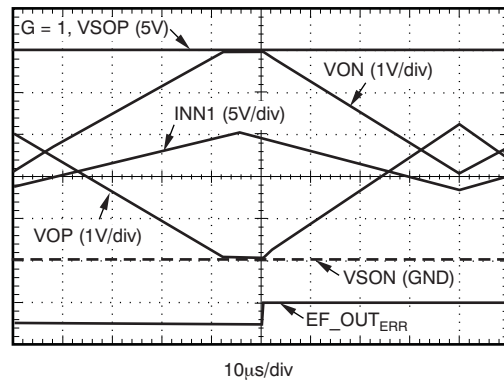

Figure 40.

TYPICAL CHARACTERISTICS (continued)

At $T_A = +25^\circ\text{C}$, $V_{SP} = +15\text{V}$, $V_{SN} = -15\text{V}$, $V_{SON} = 0\text{V}$, $V_{SOP} = 5\text{V}$, $DV_{DD} = +3\text{V}$, $DG_{ND} = 0\text{V}$, $R_L = 2.5\text{k}\Omega$ to $V_{SOP}/2 = \text{VOCM}$, $G = 1\text{V/V}$, using internal clock, BUF inactive, $V_{CM} = 0\text{V}$, and differential input and output, unless otherwise noted.

OSCILLATOR FREQUENCY vs TEMPERATURE

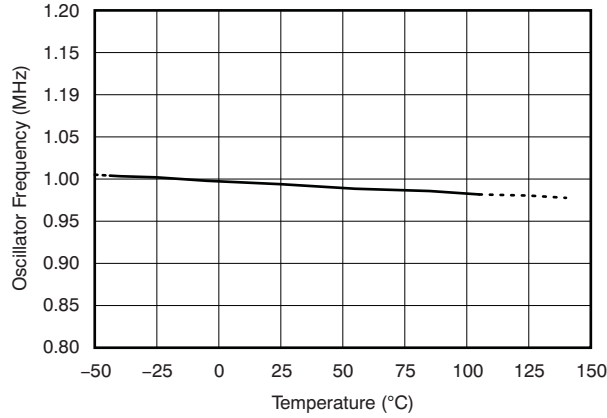

Figure 41.

INPUT CURRENT BUFFER OFFSET VOLTAGE DISTRIBUTION

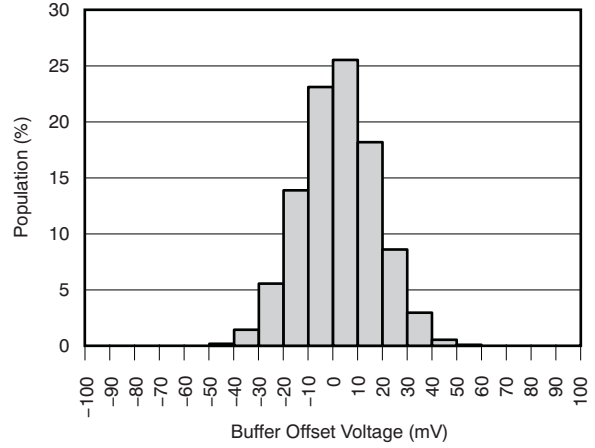

Figure 42.

APPLICATION INFORMATION

DESCRIPTION

The PGA280 is a universal high-voltage instrumentation amplifier with digital gain control. It offers excellent dc precision and long-term stability using modern chopper technology with internal filters that minimize chopper-related noise. The input gain extends from $\frac{1}{8}V/V$ (attenuation) to $128V/V$ in binary steps. The output stage offers a gain multiplying factor of $1V/V$ and $1\frac{3}{4}V/V$ for optimal gain adjustment. The output stage connects to the low-voltage (5V or 3V) supply. [Figure 43](#) shows a block diagram of the device.

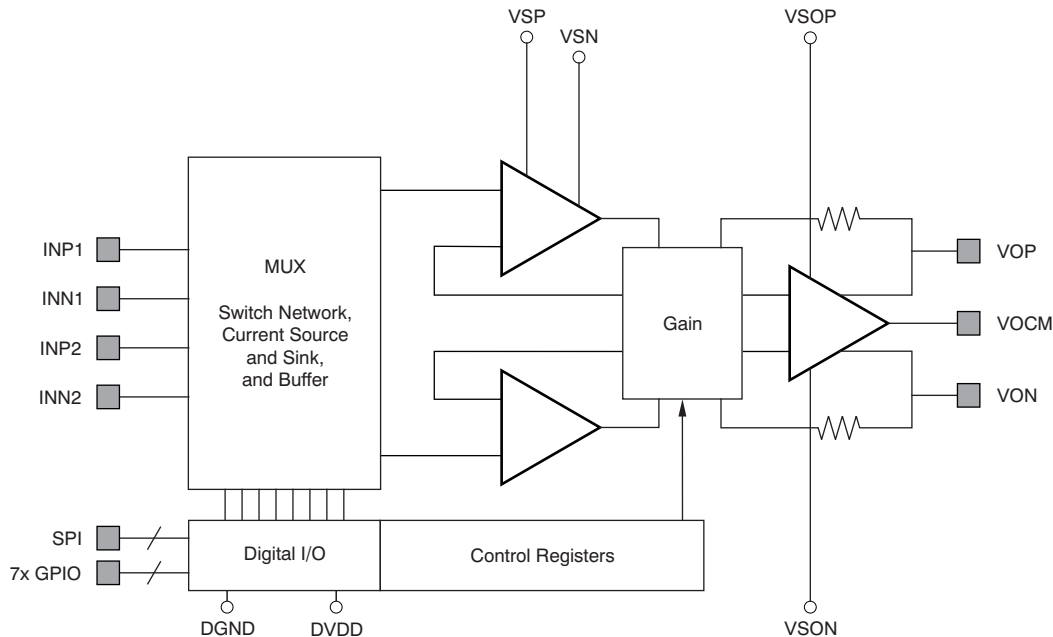

Figure 43. PGA280 Block Diagram

A signal multiplexer provides two differential inputs. Several signal switches allow signal diagnosis of wire break, input disconnect, single-ended (versus differential), and shorted inputs.

The supply voltage of up to $\pm 18V$ offers a wide common-mode range with high input impedance; therefore, large common-mode noise signals and offsets can be suppressed.

A pair of high-speed current buffers can be activated to avoid inrush currents during fast signal transients, such as those generated from switching the signal multiplexers. This feature minimizes discharge errors in passive signal input filters in front of the multiplexer.

The fully differential signal output matches the inputs of modern high-resolution and high-accuracy analog-to-digital converters (ADCs), including Delta-Sigma ($\Delta\Sigma$) as well as successive-approximation response (SAR) converters. The supply voltage for the output stage is normally connected together with the converter supply, thus preventing signal overloads from the high-voltage analog supply.

Internal error detection in the input and output stage provides individual information about the signal condition. Integrating ADCs may hide momentary overloads. Together with the input switch matrix, extensive signal and error diagnosis is made possible.

The serial peripheral interface (SPI) provides write and read access to internal registers. These registers control gain, the current buffer, input switches, and the general-purpose input/output (GPIO) or special function pins, as well as configuration and diagnostics.

The GPIO port controls the multiplexer (MUX) and switches and indicates internal conditions; it can also be individually configured for output or input. A special CS mode for the GPIO extends the communication to other external SPI devices, such as data converters or shift registers. This special function is intended for SPI communication via a minimum number of isolation couplers. Additional proof for communication integrity is provided by an optional checksum byte following each communication block.

FUNCTIONAL BLOCKS

Both high-impedance input amplifiers are symmetrical, and have low noise and excellent dc precision. These amplifiers are connected to a resistor network and provide a gain range from 128V/V down to an attenuation of $\frac{1}{8}$. The PGA280 architecture rejects common-mode offsets and noise over a wide bandwidth.

The PGA280 features additional current buffers placed in front of the precision amplifier that can be activated on demand. When activated, these additional current buffers avoid problems that result from input current during dynamic overloads, such as the fast signal transient that follows the channel switching from a multiplexer. Without the use of the additional current buffers, the fast signal transient would overload the precision amplifiers and high bias currents could flow into the protection clamp until the amplifiers recover from the overload. This momentary current can influence the signal source or passive filters in front of the multiplexer and generate long settling tails. Activating this current buffer avoids such an overload current pulse. The buffer disconnects automatically after an adjustable time. For continuous signal measurement, the additional current buffers are not used.

The switches in the input provide signal diagnostic capability and offer an auxiliary input channel (INP2 and INN2; see [Figure 44](#)). Both channels can be switched to diagnose or test conditions, such as a ground-referred, single-ended voltage measurement for either input. In this mode, each of the signal inputs can be observed to analyze common-mode offsets and noise.

The primary input channel [INP1 and INN1] provides switches and current sources for a wire break test. A switch can short both inputs. It can also discharge a filter capacitor after a wire break test, for example.

The signal inputs are diode-clamped to the supply rails. External resistors can be placed in series to the inputs to provide overvoltage protection. Current into the input pins should be limited to $\leq 10\text{mA}$.

The output stage offers a fully-differential signal around the output reference pin, VOVM. The VOVM pin is a high-impedance input and expects an external voltage, typically close to midsupply. The 3V or 5V supply of the converter or amplifier, following the PGA280 outputs, is normally connected to VSOP and VSON; this configuration shares a common supply voltage and protects the circuit from overloads. The fully-differential signal avoids coupling of noise and errors from the supply and ground, and allows large signal swing without the risk of nonlinearities that arise when driving near the supply rails.

The PGA280 signal path has several test points for critical overload conditions. The input amplifiers detect signal overvoltage and overload as a result of high gain. The output stage also detects clipping. These events are filtered with adjustable suppression delays and then stored for readout. A GPIO pin can be dedicated for external indication either as an interrupt or in a monitor mode.

A serial peripheral interface (SPI) controls the gain setting and switches, as well as the operation modes and the GPIO port pins. The SPI allows read and write access to the internal registers. These registers contain conditions, flags, and settings, as described in the [SPI and Register Description](#) section. They represent the gain setting for the input stage from 128V/V to the attenuation of $\frac{1}{8}\text{V/V}$ in binary steps and the output stage gain of 1V/V and 1.375V/V ($1\frac{3}{8}$). The input MUX and switches and the input buffers are also controlled by registers. Internal error conditions are stored and may be masked to activate an external pin in the GPIO port.

This GPIO port can be configured individually for either input or output or for a special function. In special function mode, the port indicates an error condition, generates $\overline{\text{CS}}$ signal, controls an external MUX, and connects to the buffer control and oscillator.

The port pin can act as a $\overline{\text{CS}}$ for an external SPI device. This mode connects other SPI devices [such as an analog-to-digital (A/D) converter] to the primary four-wire SPI. This feature is especially desirable when using galvanically-isolated SPI communication. An optional checksum byte further improves communications integrity.

Input Switch Network

Figure 44 shows the arrangement of the input switches. They are controlled individually via the digital SPI. The switches B1b, B2b, A1b, and A2b are controlled automatically with the buffer (BUF) operation.

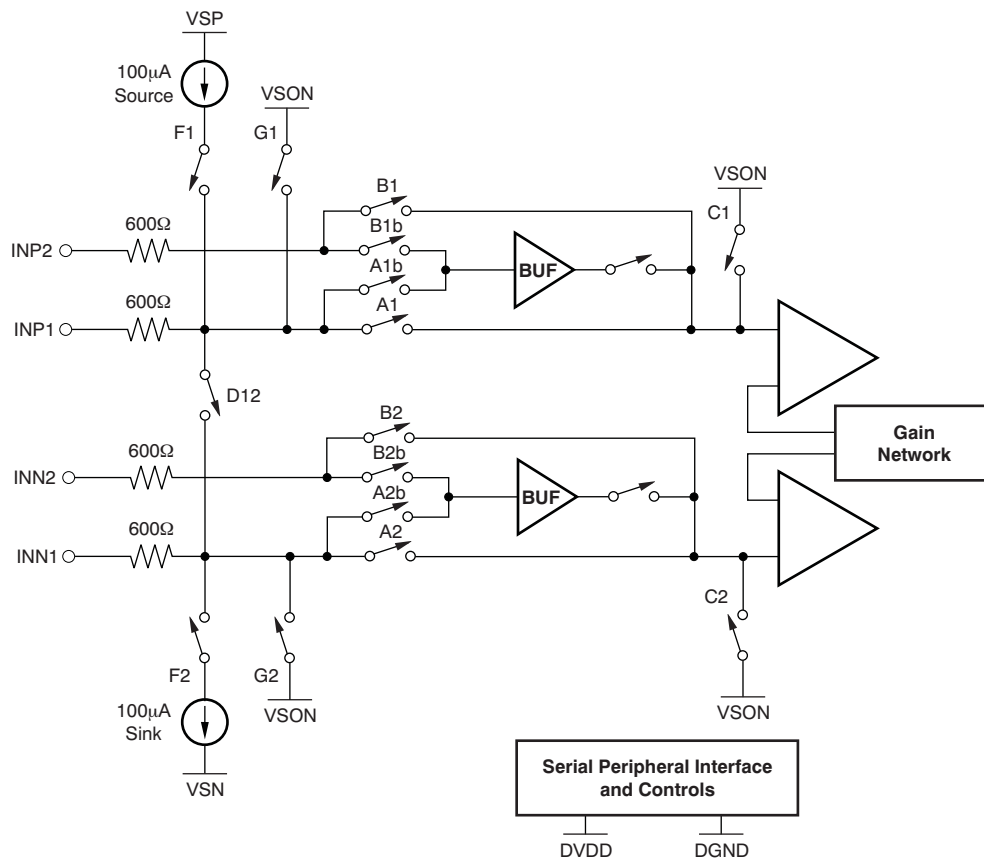

Figure 44. Input Switch Diagram

Switches A and B select the signal input. Input 1 (INP1 and INN1) provides two current sources and two switches that connect to VSON (which is typically the analog ground). This configuration is intended for wire break diagnosis. D12 can discharge an external capacitor or generate a starting condition.

Switches C1 and C2 are used to measure the input voltage referred to GND (VSON); for example, with A1 and C2 closed. This scheme measures the voltage signal connected to the input pin (INP1) referred to a common ground. The BUF output is protected against a short to VSON. See the [SPI and Register Description](#) section for more information about switch control.

Input Amplifier, Gain Network and Buffer

The high-precision input amplifiers present very low dc error and drift as a result of a modern chopper technology with an embedded synchronous filter that removes virtually all chopping noise. This topology reduces flicker noise to a minimum and therefore enables the precise measurement of small dc-signals with high resolution, accuracy, and repeatability. The chopper frequency of 250kHz is derived from an internal 1MHz clock. An external clock can also be connected, if desired.

The gain network for the binary gain steps connects to the input amplifiers, thus providing the best possible signal-to-noise ratio (SNR) and dc accuracy up to the highest gains. Gain is controlled by Register 0. This register can control the gain and address for an external MUX in one byte. Selectable gains (in V/V) are : 128, 64, 32, 16, 8, 4, 2, 1, 1/2, 1/4, and 1/8. The gain is set to 1/8V/V after device reset or power-on.

Programmable gain amplifiers such as the PGA280 use internal resistors to set the gain. Consequently, quiescent current is increased by the current that passes through these resistors. The largest amplitude could increase the supply current by $\pm 0.4\text{mA}$. In maximum overload, gain of 128V/V and each of the inputs connected to the opposite supply voltage, a current of approximately 27mA was measured. External resistors in series with the input pins that are normally present avoid this extreme condition. This current is only limited by the internal 600Ω and the switch-on resistance (see [Figure 44](#)).

Current Buffer

Designed for highest accuracy and low noise, both amplifier inputs are protected from dynamic overvoltages through clamps. The amplifier fast input slew rate (approximately $1\text{V}/\mu\text{s}$) normally prevents these clamps from turning on, provided adequate signal filtering is placed before the input. However, the fast channel switching-transient of a multiplexer or switch is much steeper, and cannot be filtered; this type of transient generates a dynamic overload. The current buffers (BUF) prevent this dynamic overload condition of the input.

With the buffers not activated, [Figure 45](#) indicates the clamp current flowing as a result of a fast signal change. The ramp in the signal, measured at the input pins (INP1), is the resulting voltage drop across the $1.5\text{k}\Omega$ resistor. In the example measurement, this resistor is placed between the signal generator and the input pin of the PGA280.

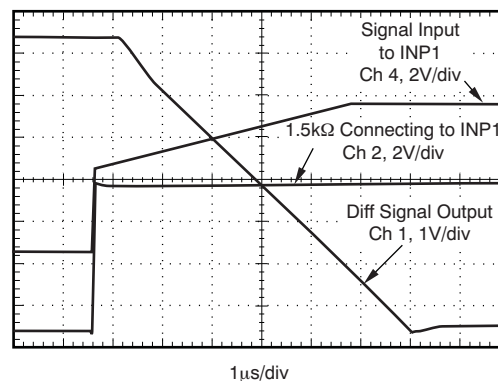
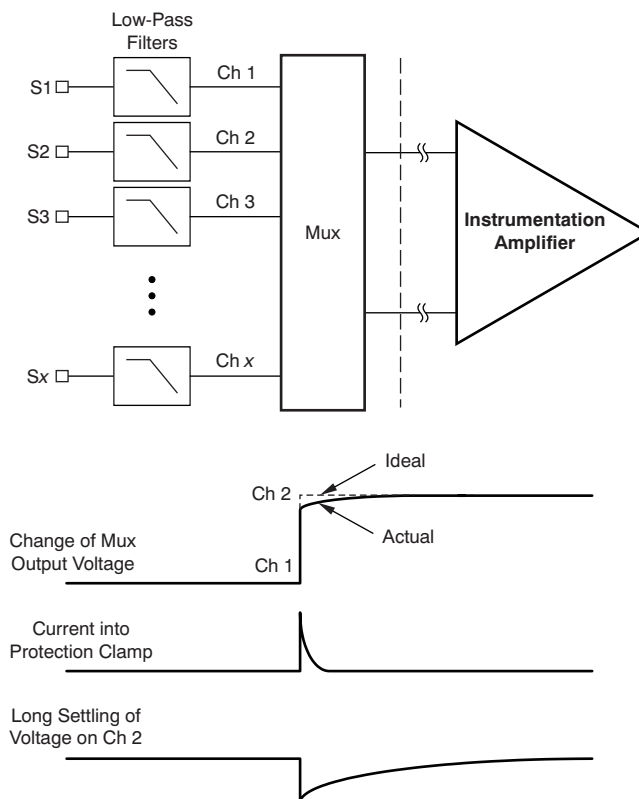

Figure 45. Buffer OFF: Input Clamp Current Flowing

[Figure 46](#) shows a typical block diagram for multiplexed data acquisition. The transient from channel 1 to channel 2, shown as a voltage step, dynamically overloads the amplifier. A current pulse results from the input protection clamp. Without the activation of the buffers (see BUF, [Figure 44](#)), the clamp current charges the filter and the signal source. Input low-pass filters are often set to settling times in the millisecond range; therefore, discharge currents from dynamic overload would produce long settling delays.



Note: Current from the protection clamp into the signal source and filter produces a long settling delay.

Figure 46. Typical Block Diagram for Multiplexed Data Acquisition

Together with the switching command of the multiplexer or internal switching, the current buffers (BUF) can be activated to prevent such clamp currents. The buffers do not have clamps as long as the signal remains within the supply boundaries. Figure 47 shows an example of the input signal settling for both conditions: without and with the buffer activated.

Without the buffer, there is an obvious long settling, depending on signal and filter impedance. With the buffer activated, only the amplifier has to settle and no distorting current is reflected into the signal source and filter; no glitch is visible in this plot. The plot shows the resulting settling of the input signal for a positive and a negative signal step as indicated in Figure 46; also shown are the SPI signal and the BUFA signal.

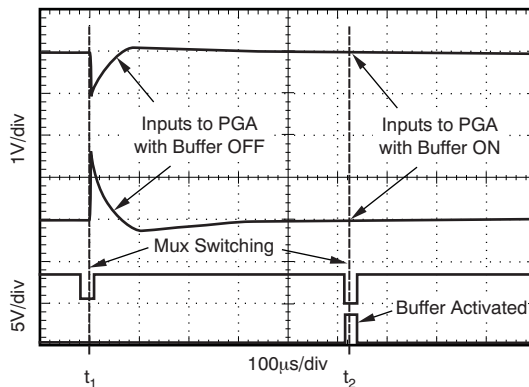

Figure 47. Example for Amplifier Settling Without (t_1) and With (t_2) Buffer (BUF) Activated

The buffers turn off automatically after a preset time (see [Register 3](#), BUFTIM). They are activated from bit 5 ('T') within the command byte. They can also be triggered by an external pin (BUFTin on GPIO4). The BUFA bit is active in conjunction with the buffer, indicating that the buffer is busy (see [Figure 55](#)).

Error detection circuits observe the signal path for signal overvoltage (IOVerr), amplifier output clipping (IARerr), and gain overload (GAINerr). The Input Clamp Activation indicator ICAerr indicates that current was conducted into the dynamic clamp circuit. These indicators help prevent misinterpretation of the analog signal and diagnose critical input signal conditions, such as those that occur with integrating analog-to-digital converters that may hide momentary overloads and present inaccurate results.

The buffers (BUF) prevent current flowing from the signal source with a compromise of offset voltage. As soon as the buffers are turned off, the amplifiers settle back to high precision. For signal measurement without (multiplexer) switching transients, the buffer is not used.

Input Protection

The input terminals are protected with internal diodes connected to VSP and VSN. If the input signal voltage exceeds the power-supply voltage (VSP and VSN), the current should be limited to less than 10mA to protect the internal clamp diodes. This current-limiting can generally be accomplished with a series input resistor.

EMI Susceptibility

Amplifiers vary in susceptibility to electromagnetic interference (EMI), but good layout practices play a critical role. EMI can generally be identified as a variation in offset voltage shifts. The PGA280 has been specifically designed to minimize susceptibility to EMI by incorporating an internal low-pass filter. Additional EMI filters may be required next to the signal inputs of the system, as well as known good practices such as using short traces, low-pass filters, and damping resistors combined with parallel and shielded signal routing, depending on the end system requirements.

Output Stage

The output stage power is connected to the low-voltage supply (normally 3V or 5V) that is used by the subsequent signal path of the system. This design prevents overloading of the low-voltage signal path.

The output signal is fully differential around a common-mode voltage (VOCM). The VOCM input pin is typically connected to midsupply voltage to offer the widest signal amplitude range. VOCM is a high-impedance input that requires an external connection to a voltage within the supply boundaries. The usable voltage range for the VOCM input is specified in the [Electrical Characteristics](#) and must be observed.

The output stage can be set to a gain of 1V/V and 1½V/V. It is set to 1V/V after device reset or power-on, and is controlled by the gain multiplication factor.

Both signal outputs, VOP and VON, swing symmetrically around VOCM. The signal is represented as the voltage between the two outputs and does not require an accurate VOCM. Therefore, the signal output does not include ground noise or grounding errors. Noise or drift on VOCM is normally rejected by the common-mode rejection capability of the subsequent signal stage.

The signal that passes through the output stage is internally monitored for two error conditions: clipping of the signal to the supply rail and overcurrent. In fault conditions, an error flag bit is set (OUTerr).

Output Filter

The PGA280 uses chopper technology for excellent dc stability over temperature and life of operation. It also avoids 1/f frequency (flicker) noise, and therefore enables both high resolution and high repeatability for dc measurements. While the chopper noise components are internally filtered, a minimal residual amount of high-frequency switching noise appears at the signal outputs. An external, passive, low-pass filter after the output stage is recommended to remove this switching noise; [Figure 48](#) shows two examples. This filter can also be used to isolate or decouple the charge switching pulses of an A/D converter input.

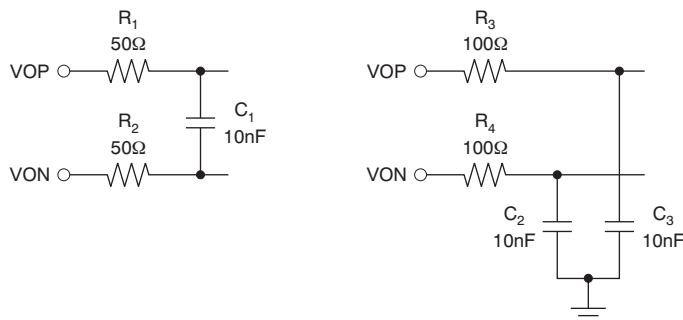

Figure 48. Typical Examples of Recommended Output Filters

Single-Ended Output

The output stage of PGA280 is designed for highest precision. The fully-differential output avoids grounding errors and noise, and delivers twice the signal amplitude compared to single-ended signals. However, if desired, the output can be taken single-ended from one of the output pins referred to the voltage at the VO_{CM} pin. The output stage errors now relate to half the signal amplitude and half the signal gain. The unused output is unconnected, but not disconnected from error detection. The usable voltage range for the VO_{CM} input is specified in the [Electrical Characteristics](#) and must be observed: the output swing (of both outputs) should not saturate to the supply. Separate specifications for offset voltage and drift indicate higher offset voltage at lower gains, because some error sources are not cancelled in the output stage connected in single-ended mode. Note that the gain is one-half of the gain set in reference to the gain table (see [Table 2](#)).

Error Detection

The PGA280 is designed for high dc precision and universal use, but it also allows monitoring of signal integrity. The device contains an input switch network for signal tests and sense points that can indicate critical conditions. These added features support fully automated system setup and diagnostic capability. Out-of linear range conditions are detected and stored in the Error Status Register ([Register 4](#)) until reset. The input switches shown in [Figure 44](#) can be used to short the input to GND, disconnect the signal, insert a 100μA test current, discharge external capacitance, and switch to a ground (V_{SON})-referenced signal measurement to observe the signal at the pin (versus the differential measurement). [Figure 49](#) illustrates the diagnostic points available for error detection in the device architecture.

All switches are controlled through the SPI. The error signals can be combined using a logic OR function to an output pin and eventually be used as an error interrupt signal. Errors are normally latched, unless the LTD bit (latch disable) is set.

The error sensors are filtered with a suppression delay ([Register 11](#)). These error signals are normally suppressed during the buffer (BUFA) active time.

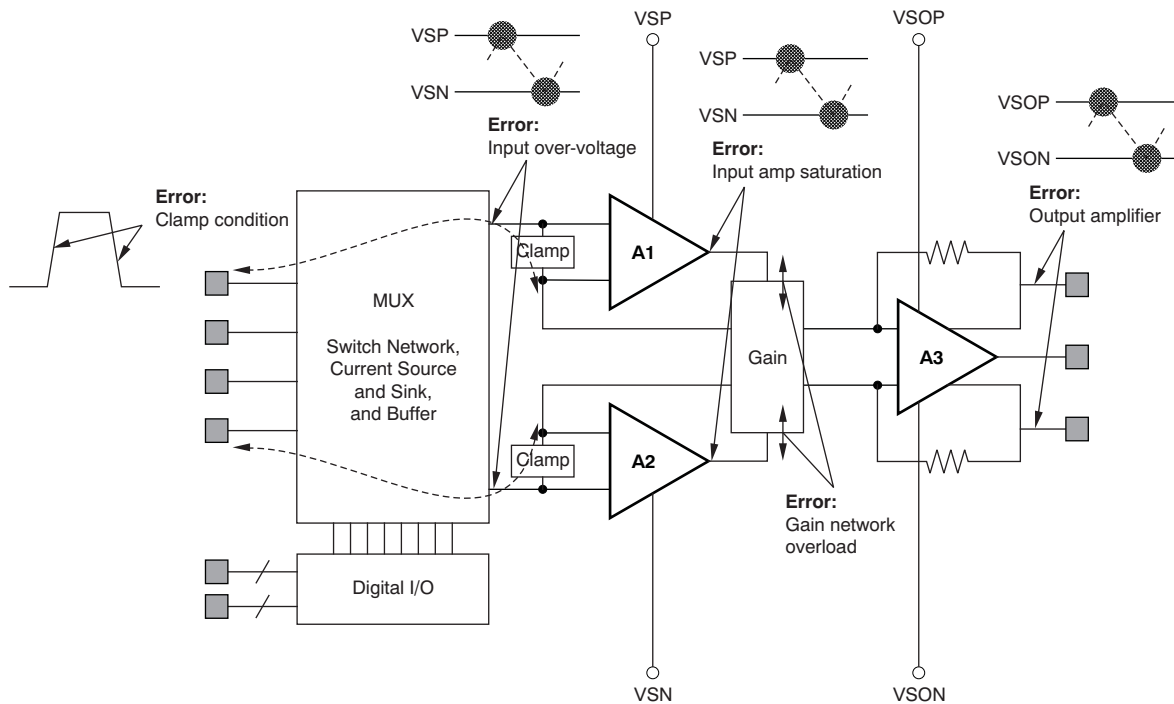

Note: The signal path is observed for possible limitations; flags are stored and indicated in [Register 4](#).

Figure 49. Diagnostic Points for Error Detection

ERROR INDICATORS

Input Clamp Conduction (ICAerr)

The input clamp protects the precision input amplifier from large voltages between the inputs that occur from a fast signal slew rate in the input. This clamp circuit pulls current from the input pins while active. Current flowing through the clamp can influence the signal source and cause long settling delays on passive signal filters. The current is limited by internal resistors of approximately 2.4kΩ. Dynamic overload can result from the difference signal as well as the common-mode signal.

The input clamp turns on when the input signal slew rate is faster than the amplifier slew rate (see the [Electrical Characteristics](#) specification) and larger than $\pm 1V$. Appropriate input filtering avoids the activation. However, transients from MUX switching, internal switches, and gain switching action cannot be filtered; therefore, to avoid these transients, it is recommended that the current buffer (BUF) be activated. The buffer isolates the signal input from the clamp, and therefore avoids the current pulse (see [Figure 44](#)).

Input Overvoltage (IOVerr)

The input amplifier can only operate at high performance within a certain input voltage range to the supply rail. The IOVerr flag indicates a loss of performance because of the input voltage or the amplifier output approaching the rail.

Gain Network Overload (GAINerr)

The gain setting network is protected against overcurrent conditions that arise because of an improper gain setting. The current into the resistors is proportional to the voltage between both inputs and the internal resistor; a low resistor value results in high gains. This error flag indicates such an overload condition that is the result of an improper gain setting.

Output Amplifier (OUTerr)

The output stage is monitored for signal clipping to the supply rail and for overcurrent conditions.

Checksum Error (CRCerr)

SPI communication can include a checksum byte for increased data integrity, when enabled. It is especially useful for an isolated SPI. This error detection is only active with the checksum activated. See the [Checksum](#) section for details.

POWER SUPPLY

The PGA280 can connect to three supply voltages: the high-voltage analog supply, the low-voltage output amplifier supply, and the digital I/O supply. This architecture allows an optimal interface (level-shift) to the different supply domains.

The high-voltage analog supply, VSP and VSN, powers the high-voltage input section. The substrate of the IC is connected to VSN; therefore, it must be connected to the most negative potential.

The low-voltage analog output supply, VSOP and VSON, can operate within the high-voltage supply boundaries with two minimal limitations:

1. The usable range for VSON is from a minimum 5V below VSP to as low as VSN. This 5V provides the headroom for the output supply voltage of +2.7V to +5V. Even with less than 5V supply, this voltage difference is required for proper operation.
2. The common-mode control input, VOXM, requires a voltage at least 2V from VSP, in order to support internal rail-to-rail performance.

These limits may only come into consideration when using a minimum supply or an extremely asymmetrical high-voltage supply. In most practical cases, VSON is connected to the ground of the system 3V or 5V supply.

VSOP can be turned on first or can be higher than VSP without harm, but operation fails if VSP and VSN are not present.

Observe the maximum voltage applied between VSOP and VSON, because there is no internal protection. This consideration is the same as with other standard operational amplifier devices.

The digital supply, DGND and DVDD, can also be set within the boundaries of VSP and VSN. Only the positive supply, DVDD, cannot be closer than 1V below VSP. It can be turned on without the analog supply being present and is operational, but limited to digital functions in this case. The maximum supply voltage must be observed because there is no internal protection. VSOP and VSON can be connected with DVDD and DGND, if desired.

Current consumption of the digital supply is very low under static conditions, but increases with communications activity. Assuming no external load except the 20pF load to SDO, with an SCLK = 10MHz and a 3V supply, the current momentarily increases by approximately 0.6mA when reading a register (for example, reading Register 14). With a 5V digital supply, the increase is in the range of 0.8mA. This additional current is only required during communication; a larger bypass capacitor can supply this current. Driving current into SDO would further increase the current demand.

VSN is connected to the substrate; therefore, the voltage at VSON or DGND must not turn on the substrate diode to VSN. Use external Schottky diodes from VSON to VSN and from DGND to VSN (refer to [Figure 50](#)) to prevent such a condition.

The PGA280 uses an internal chopper technology and therefore works best with good supply decoupling. Series resistors in the supply are recommended to build an RC low-pass filter. With the small supply current, these series resistors can be in the range of 15Ω to 22Ω. The RC filter also prevents a very fast rise time of the supply voltage, thus avoiding parasitic currents in the IC. Connecting supply wires into an already-turned on supply (very fast rise time) without such a filter can damage the IC as a result of voltage overshoot and parasitic charge currents. [Figure 50](#) shows an example of a supply connection using RC bypass filters. DVDD may not need decoupling, but if the digital supply is noisy, a filter is recommended at C₄ and R₄.

NOTE

Rise and fall times for the high-voltage supplies must be slower than 1V/μs.

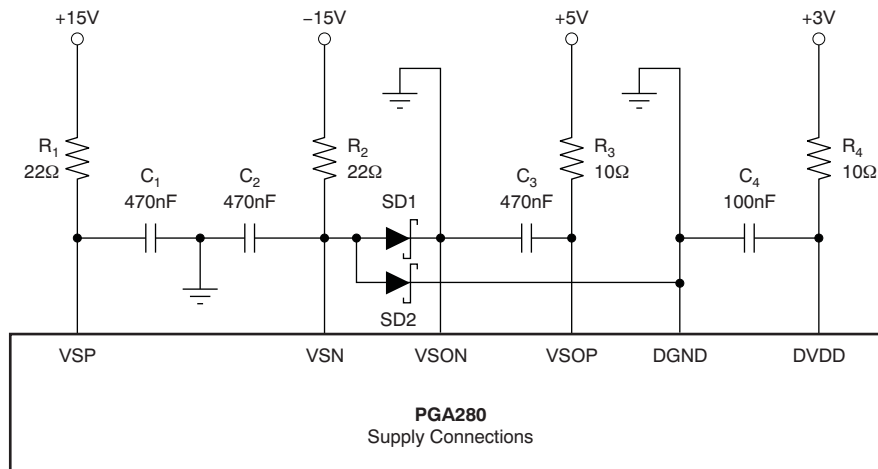

Note: In this example, the Schottky diodes prevent substrate reversing. The supply voltages shown are only example values.

Figure 50. Supply Connection Example Using RC Bypass Filters for Good Decoupling

External Clock Synchronization

The PGA280 uses an internal oscillator of 1MHz, nominally. This clock can be brought out to pin GPIO6 if configured by the internal register setting to allow synchronization of external systems to this clock. If the PGA280 must be controlled by an external clock, GPIO6 can be configured as an oscillator input, thus overriding the internal oscillator. The frequency range must be within the specified range shown in the [Electrical Characteristics](#) in order to maintain stable device performance. The clock pulse width is not critical, because it is internally divided down; however, less than 30% deviation is recommended. The GPIO6 input assumes a standard logic signal. Prevent overshoot at this pin, and provide approximately equal rise and fall time for the lowest influence on offset voltage as a result of coupled noise.

Expect a small amount of additional noise during the transition from internal to external clock, or vice-versa, for approximately eight clock periods because of phase mismatch.

Quiescent Current

The PGA280 uses internal resistor networks and switches to set the signal gain. Consequently, the current through the resistor network may vary with the gain and signal amplitude. Under normal operation, the gain-related current is low (less than 400µA). However, in signal overload conditions while a high gain is selected, this amount of current can increase.

Settling Time

The PGA280 provides very low drift and low noise, and therefore allows repeatable settling to a precise value with a negligible tail. Signal-related load and power dissipation variables have minimal effect on the device accuracy.

Overload Recovery

Overload conditions can vary widely, and there are multiple points in an instrumentation amplifier that can be overloaded. During input overload, the PGA280 folds the output signal partially back as a result of the differential signal structure and summing, but the error flags indicate such fault conditions. The amplifier recovers safely after removing the overload condition, as long as it is within the specified operating range as shown in [Figure 51](#).

Avoid dynamic overload by using adequate signal filtering that reduces the input slew rate to the slew rate of the amplifier. Fast signal jumps produced from multiplexed signal sources or gain changes cannot normally be filtered, but the current buffer (BUF) stage can be activated to prevent current flowing through the input into the protection clamp in such situations.

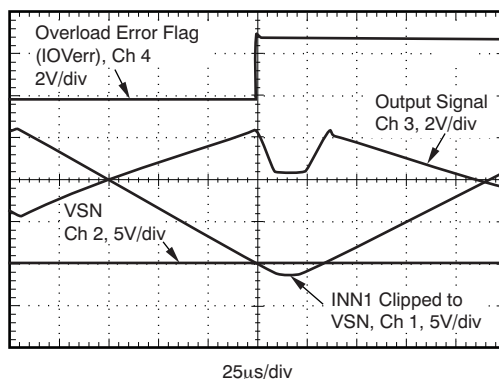

Figure 51. Input Clipping: Negative Side

SPI and Register Description

The serial peripheral interface uses four wires: \overline{CS} (input), clock (SCLK, input), data in (SDI, or slave data input), and data out (SDO, or slave data output) and operates as a slave.

\overline{CS} is active low; data are sampled with the negative clock edge. It is insensitive to the starting condition of SCLK polarity (SPOL = 1 or 0). See [Figure 52](#) and [Figure 53](#).

The SPI communicates to the internal registers, starting with a byte for command and address. It is followed by a single data byte (exception: *11tx 0ccc* requires no data byte). The communication can include a checksum byte. When enabled, this byte follows the last valid byte. Either power on reset or software reset (SftwrRst) disables the checksum mode. Writing to Register 11 enables or disables checksum mode.

On a read command, the device responds with the data byte and the checksum byte. If the checksum is not desired, setting \overline{CS} to high terminates the transmission.

Multiple commands can be chained by holding \overline{CS} low and sending the additional commands after the checksum byte (if checksum is disabled, send a dummy byte). In this mode, read and write instructions can be mixed.

This interface allows clock rates up to 10MHz. Such high clock rates require careful board layout, short wire lengths, and low parasitic capacitance and inductance. Observe delays and distortion generated from isolation couplers. External drivers may be required to drive long and terminated cables.

COMMAND STRUCTURE AND REGISTER OVERVIEW

Bit 7 is the most significant bit (MSB); bit 0 is the least significant bit (LSB). Binary numbers are denoted with 'b'. 'aaaa' is used to denote the encoded register pointer, 0000b to 1111b. 'T' denotes the buffer trigger bit. Writing to unassigned bits is ignored, but it is recommend to write a '0' for all unassigned bits. PGA280 registers, addresses, and functional information are summarized in the Register Map ([Table 1](#)).

Command Byte

01T0 aaaa dddd dddd: Write

Write 'dddd dddd' to internal PGA280 register at address *aaaa*

1000 aaaa 0000 0000: Read

Read from specified internal PGA280 register at address *aaaa* [no BUFT on read]. The number of trailing zeros provides the clock for reading data. 16 SCLK pulses are required when reading the data byte plus checksum.

00T0 aaaa:

Factory-reserved commands.

11T0 0ccc: Direct \overline{CS} Command

Controls \overline{CS} to pin (all pins are \overline{CS} -capable, but not simultaneously; only one at a time) for *ccc* = 0 to 6, corresponding to GPIO0 to GPIO6, if \overline{CS} mode is activated.

Within the command byte, T = 1 triggers the current buffer (BUF). Each command is terminated with setting \overline{CS} to high; commands can be chained within a period of \overline{CS} active low, but require a checksum byte, or a dummy byte when checksum mode is disabled.

NOTE

BUF cannot be triggered during a read command.

Here are several examples (discrete commands):

Read Register 3:

Send 0x8300; response: 0xzz19 (this value is the initial setting of BUFTIM).

The first byte zz contains the line state (3-state) of SDO. The second byte is data.

NOTE

The PGA280 sends the CHKsum, if clocks are available while \overline{CS} : Send 0x830000.
Response: 0xzz1937

Write Register 0:

Send 0x4018; set gain to 1V/V.

Write Register 4:

Send 0x44FF; reset all error flags.

Read Register 4:

Send 0x8400; response: 0xzz00 (no error flags set).

Extended \overline{CS}

The PGA280 can generate an extended chip select (\overline{ECS}) for other devices that are connected to the same SPI wires: SDO, SDI, and SCLK. This \overline{ECS} signal redirects the SPI communication to the connected device, while the PGA280 ignores data and SCLK. The \overline{CS} signal to the PGA280 must stay low during such communication; as soon as \overline{CS} returns high, SPI communication is terminated. See the [GPIO Operation Mode](#) section for details.

Table 1. REGISTER MAP⁽¹⁾

REGISTER (Decimal, [Hex]) ⁽²⁾	aaaa (Binary)	R/W	B7	B6	B5	B4	B3	B2	B1	B0	DESCRIPTION	RESET VALUES ⁽³⁾
0	0000	W/R	G4	G3	G2	G1	G0	MUX2	MUX1	MUX0	Gain and optional MUX register	0000 0000b
1	0001	W								SftwrRst Note2x	Write-only register, soft reset, write 1	0000 0000b
2	0010	W/R		CP6	CP5	CP4	CP3	CP2	CP1	CP0	SPI-MODE selection to GPIO-pin	0000 0000b
3	0011	W/R			BUFTIM5	BUFTIM 4	BUFTIM3	BUFTIM 2	BUFTIM1	BUFTIM 0	Set BUF time-out	0001 1001b
4	0100	W/R	CHKerr	IARerr	BUFA	ICAerr	EF	OUTerr	GAINerr	IOVerr	Error Register; reset error bit: write 1	0000 0000b
5	0101	W/R		GPIO6	GPIO5	GPIO4	GPIO3	GPIO2	GPIO1	GPIO0	GPIO Register Data force out or sense	0000 0000b
6	0110	W/R		SW-A1	SW-A2	SW-B1	SW-B2	SW-C1	SW-C2	SW-D12	Input switch control	0110 0000b
7	0111	W/R					SW-F1	SW-F2	SW-G1	SW-G2	Input switch control	0000 0000b
8	1000	W/R		DIR6	DIR5	DIR4	DIR3	DIR2	DIR1	DIR0	Configure pin to out = 1 or in = 0	0000 0000b
9	1001	W/R		ECS6	ECS5	ECS4	ECS3	ECS2	ECS1	ECS0	Extended \overline{CS} mode (1 = enable)	0000 0000b
10 [A]	1010	W/R	MUX-D dis	IARerr dis	BUFAPol at pin	ICAerr dis	ED BUFA suppress	OUTerr dis	GAINerr dis	IOVerr dis	Various configuration settings	0000 0000b
11 [B]	1011	W/R	LTD		FLGTIM3	FLGTIM 2	FLGTIM1	FLGTIM 0	Reserved	CHKsu mE	Various configuration settings	0001 0000b
12 [C]	1100	W/R	OSCout	SYNCin	BUFAout	BUFTin	EFout	MUX2	MUX1	MUX0	Special function register	0000 0000b
	PIN			GPIO6	GPIO5	GPIO4	GPIO3	GPIO2	GPIO1	GPIO0	Register bit reference to GPIO pin ⁽⁴⁾	

- (1) Blank register bits are ignored and undefined.
- (2) Registers 13 to 15 are for test purposes; read-only.
- (3) Power-on reset values are SftwrRst values.
- (4) Details for GPIO pin assignments are shown in [Figure 54](#).

SPI Timing Diagrams (Read and Write)
(SCLK—Data—CS)

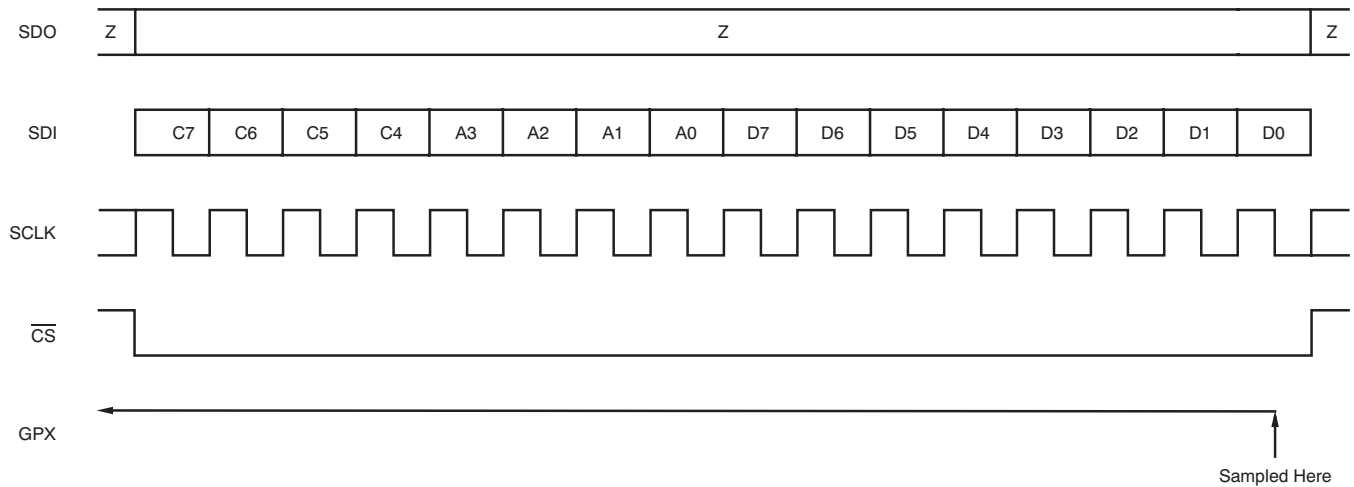

Figure 52. Write (to Device) Timing (GPX: Command Decoding); No Checksum Enabled.
With Checksum, Command Decoding Occurs After 24th Falling Edge of SCLK

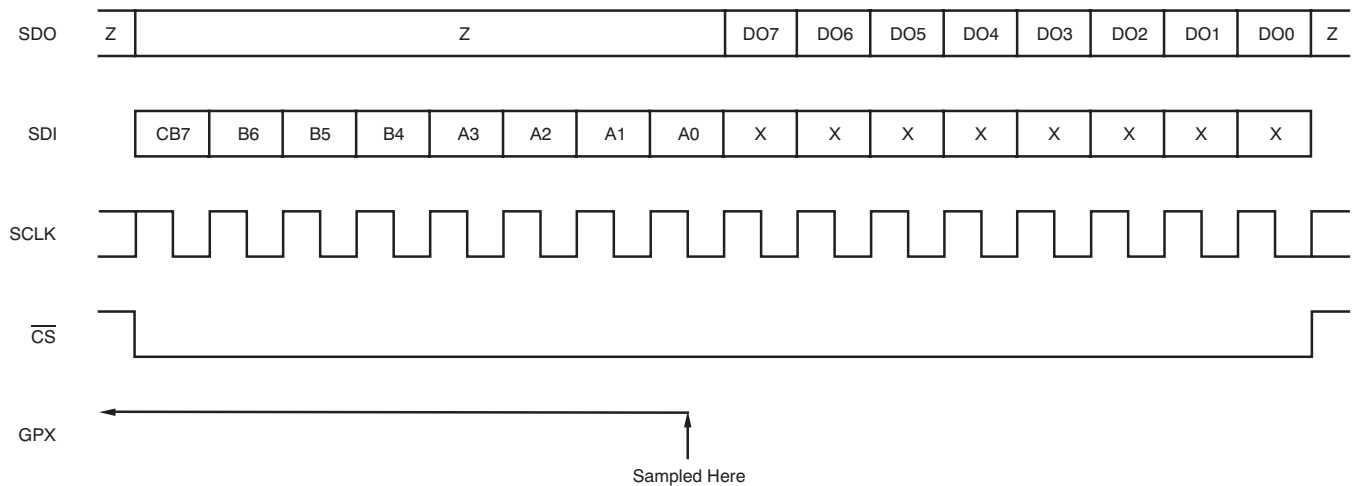

Figure 53. Read (From Register) Timing (GPX: Command Decoding); No Checksum Enabled.
Falling Edge of SCLK Controls Logic

GPIO Pin Reference

As shown in Figure 54, the PGA280 has seven multi-function pins labeled GPIO0 through GPIO6. These pins can function as general purpose input-output (GPIO) pins either to read a digital input or to output a digital signal as an interrupt or control. GPIO functions are controlled through Register 5 and Register 8.

These pins can also be programmed to have additional special functions for the PGA280. Each of these seven pins can be used as an output for the extended chip select function ($\overline{\text{ECS}}$), using the PGA280 to redirect the SPI communications to other connected devices. $\overline{\text{CS}}$ Configuration Mode is enabled through Register 9. Additionally, Register 2 controls the clock polarity (CP) of each $\overline{\text{ECS}}$. For each bit set to '1', a positive edge of SCLK follows $\overline{\text{CS}}$ (CP = 0); for each bit set to '0', a negative edge of SCLK follows $\overline{\text{CS}}$ (CP = 1).

Together with the GPIO and $\overline{\text{ECS}}$ functions, the seven pins can perform more specialized input and output tasks as controlled by Register 12, the Special Functions Register.

GPIO0, GPIO1, and GPIO2 can be used to control an external multiplexer. If the MUX function is enabled in the first three bits of Register 12, the output value on the MUX pins is controlled through Register 0. This configuration allows for simultaneous control of the PGA280 gain and external multiplexer settings by writing to a single register.

GPIO3 can be used to output an error flag. As with bit 3 of Register 4, this option would be the logical OR of the error bits in Register 10 (IARerr, ICAerr, OUTerr, GAINerr, and IOVerr).

GPIO4 can be used as an input to trigger the current buffer. The low-to-high edge of a pulse starts the buffer with a delay of three to four clock cycles. If held high, the buffer [BUFA] remains active. It is extended by a minimum of three to four clock cycles in addition to the time set with FLAGTIM.

GPIO5 can be configured as an output to indicate a buffer active condition. The polarity is controlled by BUFApol of bit 5 in Register 10.

GPIO6 can be configured as either an output or an input with the Special Functions Register. With Bit 7, OSCOUT connects the internal oscillator to GPIO6. With Bit 6, SYNCIN allows an external oscillator to provide the master clock to the PGA280.

To use any of these functions, Register 8 must first be set to '0' for input or to '1' for an output (for GPIO, $\overline{\text{ECS}}$, or special function).

Once set, any 1s in Register 9 supersede the GPIO function for the related pin, allowing for $\overline{\text{CS}}$ configuration.

Likewise, any 1s in Register 12 supersede the GPIO function and $\overline{\text{CS}}$ configuration, allowing for any of the pin-specific special functions to operate.

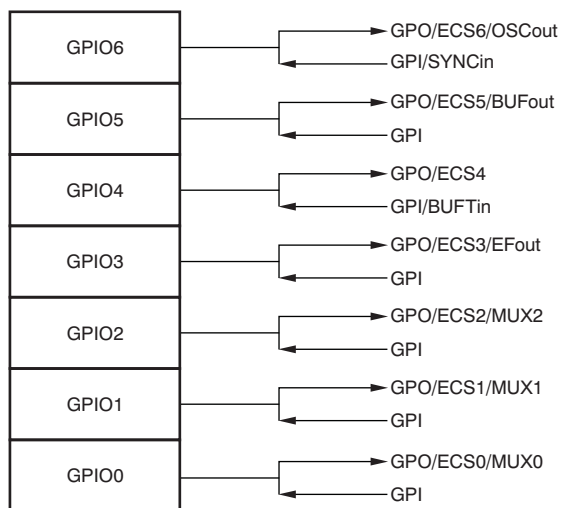

Figure 54. Special Function to Pin Assignment Reference

REGISTER INFORMATION

REGISTER DETAILS

Register 0: Gain and External MUX Address (Read = 0x8000; Write with BUF Off = 0x40, Write with BUF On = 0x60)

Bit #	D7	D6	D5	D4	D3	D2	D1	D0
Bit Name	G4	G3	G2	G1	G0	MUX2	MUX1	MUX0
POR Value	0	0	0	0	0	0	0	0

Bit Descriptions:

G4: Output stage gain setting. This setting is independent of the gain selected in the input stage and acts as a multiplication factor to the input gain.

0 = 1V/V output gain (power-on default)

1 = 1.375V/V output gain (= 1³/₈V/V)

G[3:0]: Input stage gain setting. Refer to [Table 2](#).

MUX[2:0]: These ports can be used to control an external multiplexer.

Table 2. INPUT STAGE GAIN SETTINGS

G3	G2	G1	G0	Gain
0	0	0	0	1/8
0	0	0	1	1/4
0	0	1	0	1/2
0	0	1	1	1
0	1	0	0	2
0	1	0	1	4
0	1	1	0	8
0	1	1	1	16
1	0	0	0	32
1	0	0	1	64
1	0	1	0	128
1	0	1	1	Reserved
1	1	0	0	Reserved
1	1	0	1	Reserved
1	1	1	0	Reserved
1	1	1	1	Reserved
1	1	1	1	Reserved

Register 1: Software Reset Register (Write = 0x4101; Write with Checksum = 0x4101DD)

Bit #	D7	D6	D5	D4	D3	D2	D1	D0
Bit Name	—	—	—	—	—	—	—	SftwrRst
POR Value	0	0	0	0	0	0	0	0

Bit Descriptions:

SftwrRst: Software Reset.

Setting this bit to '1' generates a system reset that has the same effect as a power-on reset. All registers are reset to the respective default values; this bit self-clears.

Register 2: SPI: MODE Selection to GPIO-Pin (Read = 0x8200, Write = 0x012)

Bit #	D7	D6	D5	D4	D3	D2	D1	D0
Bit Name	—	CP6	CP5	CP4	CP3	CP2	CP1	CP0
POR Value	0	0	0	0	0	0	0	0

Bit Descriptions:

CP[6:0] SPI mode₁ or mode₂ can be configured for each individual $\overline{\text{ECS}}$ (extended CS) output if activated in Register 9. See $\overline{\text{CS}}$ Mode in [GPIO Operation Mode](#) for details. CP6 controls ECS6, for example. For SPI mode₁, set the respective bit to '1': a positive edge of SCLK follows $\overline{\text{CS}}$ (Clock Polarity, CP = 0). For SPI mode₂, set the respective bit to '0': a negative edge of SCLK follows $\overline{\text{CS}}$ (CP = 1). See also [Figure 56](#).

Register 3: BUF Timeout Register (Read = 0x8300, Write = 0x43)

Bit #	D7	D6	D5	D4	D3	D2	D1	D0
Bit Name	—	—	BUFTIM5	BUFTIM4	BUFTIM3	BUFTIM2	BUFTIM1	BUFTIM0
POR Value	0	0	0	1	1	0	0	1

Bit Descriptions:

BUFTIM[5:0] Defines BUF timeout length. The LSB equivalent is 4*t CLK (nominal value is 4μs with a 1MHz clock). Setting this register to 0x00 disables the BUF. The minimum timeout length that can be set is approximately 6μs. The default/POR setting sets BUFA time on to 100μs. The BUFA bit of the Error Register [D5] indicates the buffer active status. See [Figure 55](#).

Register 4: Error Register (Read = 0x8400, Write = 0x44)

Bit #	D7	D6	D5	D4	D3	D2	D1	D0
Bit Name	CHKerr	IARerr	BUFA	ICAerr	EF	OUTerr	GAINerr	IOVerr
POR Value	0	0	0	0	0	0	0	0

The Error Register flags activate whenever an error condition is detected. These flags are cleared when a '1' is written to the error bit.

Bit Descriptions:

CHKerr: Checksum error in SPI. This bit is only active if checksum is enabled. This bit is set to '1' when the checksum byte is incorrect.

IARerr: Input Amplifier Saturation

BUFA: Buffer Active

ICAerr: Input Clamp Active

EF: Error Flag. Logic OR combination of error bits of Register 10. This bit can be connected to GPIO3 pin if it is configured for output (Register 8) and as a special function (Register 12).

OUTerr: Output Stage Error (allow approximately 6μs activation delay).

GAINerr: Gain Network Overload

IOVerr: Input Overvoltage

Register 5: GPIO Register (Read = 0x8500, Write = 0x45)

Bit #	D7	D6	D5	D4	D3	D2	D1	D0
Bit Name	—	GPIO6	GPIO5	GPIO4	GPIO3	GPIO2	GPIO1	GPIO0
POR Value	0	0	0	0	0	0	0	0

Bit Descriptions:

GPIO[6:0]: The GPIO bits correspond to GPIO6 through GPIO0, respectively. The function of each bit depends on whether the GPIO pin is configured as an input pin or an output pin, which is determined by the setting in Register 8. When the GPIO pin is configured as an input, reading this register samples the GPIO pin. When the GPIO pin is configured as an output, reading from this register reads back the forced data.

Register 6: Input Switch Control Register 1 (Read = 0x8600, Write = 0x46)

Bit #	D7	D6	D5	D4	D3	D2	D1	D0
Bit Name	—	SW-A1	SW-A2	SW-B1	SW-B2	SW-C1	SW-C2	SW-D12
POR Value	0	1	1	0	0	0	0	0

Bit Descriptions:

Switch control; see [Figure 44](#) for switch designation (switch closed = 1).

Example: Select INP2 and INN2: 0x18 // opens A1 and A2, and closes B1 and B2.

Register 7: Input Switch Control Register 2 (Read = 0x8700, Write = 0x47)

Bit #	D7	D6	D5	D4	D3	D2	D1	D0
Bit Name	—	—	—	—	SW-F1	SW-F2	SW-G1	SW-G2
POR Value	0	0	0	0	0	0	0	0

Bit Descriptions:

Switch control; see [Figure 44](#) for switch designation.

Register 8: GPIO Configuration Register (Read = 0x8800, Write = 0x48)

Bit #	D7	D6	D5	D4	D3	D2	D1	D0
Bit Name	—	DIR6	DIR5	DIR4	DIR3	DIR2	DIR1	DIR0
POR Value	0	0	0	0	0	0	0	0

Bit Descriptions:

DIR[6:0]: GPIO configuration for input or output; 0 for input; 1 for output. Power-on default is all *inputs* (requires external termination or set to output).

Register 9: \overline{CS} Configuration Mode Register (Read = 0x8900, Write = 0x49)

Bit #	D7	D6	D5	D4	D3	D2	D1	D0
Bit Name	—	ECS6	ECS5	ECS4	ECS3	ECS2	ECS1	ECS0
POR Value	0	0	0	0	0	0	0	0

Bit Descriptions:

ECS[6:0]: Configure \overline{CS} function to respective pins. See \overline{CS} Mode, in the [GPIO Operation Mode](#) section (a single byte command applies).

Register 10: Configuration Register 1 (Read = 0x8A00, Write = 0x4A)

Bit #	D7	D6	D5	D4	D3	D2	D1	D0
Bit Name	MUX-D	IARerr	BUFA Pol	ICAerr	ED BUFA	OUTerr	GAINerr	IOVerr
POR Value	0	0	0	0	0	0	0	0

Bit Descriptions:

MUX-D: Set this bit to '1' to disable MUX control from Register 0; set to '0' after reset.

BUFA Pol: Controls BUF active indication polarity. Set to '0' for high = active; set to '1' for low = active.

ED BUFA Suppress: Error detection is normally disabled during BUFA active. Errors are not suppressed if ED BUFA = 1.

Error flags are logic OR-combined and connected to the 'EFout' in Register 12 as well as connected to the GPIO3 output pin if configured. The EFout signal is active high. Assigned errors can be disabled individually using this OR function, with the exception of 'CHKerr', by writing a '1' to the error bit position. [IARerr; ICAerr; OUTerr; GAINerr; IOVerr]

Register 11: Configuration Register 2 (Read = 0x8B00, Write = 0x4B)

Bit #	D7	D6	D5	D4	D3	D2	D1	D0
Bit Name	LTD	—	FLGTIM3	FLGTIM2	FLGTIM1	FLGTIM0	Reserved	CHKsumE
POR Value	0	0	0	1	0	0	0	0

Bit Descriptions:

LTD: Individual error signals are not latched if this bit is set to '1'. With EFout activated on GPIO3, the error condition can be observed in real time, but error suppression time is applied. Clear errors in Register 4 after writing '1' to this bit.

FLAGTIM0 to 3: Choose the number of clock cycles (nominally 1MHz) according to [Table 3](#) for suppression of the error flags in Register 4. The timeout starts after the end of BUFA. Alternatively, it can start with the event if the buffer is not active or Register 10, bit 3 is set high. Allow delayed activation for the individual error sources in the microsecond range.

Table 3. Error Flag Suppression Time

FLGTIM [3:0]	CLOCK CYCLES ⁽¹⁾
0000	0
0001	1
0010	2
0011	3
0100	4
0101	5
0110	6
0111	7
1000	8
1001	12
1010	16
1011	24
1100	32
1101	48
1110	64
1111	127

(1) Clock cycles refer to internal clock or SYNCin; nominally 1MHz.

CHKsum is enabled by writing a '1' to this bit. A correct checksum is always required for enabling. Once set, all communication to the device requires a valid checksum, until '0' is written to this bit. Alternatively, a software reset [0x4101DD] or power-on reset can be performed to reset this function.

Register 12: Special Functions Register (Read = 0x8C00, Write = 0x4C)

Bit #	D7	D6	D5	D4	D3	D2	D1	D0
Bit Name	OSCOut	SYNCin	BUFAout	BUFTin	EFout	MUX2	MUX1	MUX0
POR Value	0	0	0	0	0	0	0	0

Bit Descriptions:

Special function pin designation: Set to '1' for activation.

OSCOut: Internal oscillator connected to pin GPIO6 for output (GPIO6 configured as an output).

SYNCin: External connection for external oscillator input to pin GPIO6 (GPIO6 configured as an input).

BUFAout: Pin GPIO5 indicates a buffer active condition (if configured as an output). The BUFA output signal is active high by default, but can be inverted to active low by BUFA Pol.

BUFTin: The current buffer can be triggered externally by pin GPIO4, if configured as an input. The low-to-high edge of a pulse starts the buffer with a delay of three to four clock cycles. If held high, the buffer [BUFA] remains active. It is extended by a minimum of three to four clock cycles plus the time set with FLAGTIM.

EFout: A logic OR combination of error bits; see [Register 10](#). This flag can control GPIO3 if this pin is configured as an output and EFout = 1.

MUX2 to MUX0: If the GPIO pins are configured as outputs and these bits are set to '1', the GPIO pins are controlled from Register 0 (if MUX-D = 0).

GPIO Configuration

Register priority: If GPIO pins are used, follow this procedure:

First, configure individual I/O bits as either inputs or outputs (Register 8); '0' = input, '1' = output. Bits B0 to B6 are connected to GPIO0 to GPIO6, respectively.

Then, configure individual bits to the desired function. When configuring for output, set the Data Register (Register 5) first to avoid glitches.

To configure the GPIO pins for the \overline{CS} function (see [Register 9](#)):

- Configure \overline{ECS} ('0' = disable, '1' = enable). If set to '1' and the I/O configuration is set to output as well, this pin becomes \overline{ECS} . Details of this configuration are described in [GPIO Operation Mode](#), [CS Mode](#).
- Configure for clock polarity (CP), relative to \overline{ECS} in Register 2; see [Register 9](#). Set this bit to '0': a negative edge of SCLK follows \overline{ECS} (CP = 1). Set this bit to '1': a positive edge of SCLK follows \overline{ECS} (CP = 0).
- Configure for special function (Register 12): Special function signals can be assigned to the GPIO pins in this manner: 0 = disable, 1 = enable. Pins *xxout* must be configured as outputs, and *xxin* must be configured as inputs in Register 8.
- GPIO data to force (Register 5) GPIO data (1 = low, 0 = high). Forcing a bit, which is assigned to a special function, may be stored until GPIO is enabled.

NOTE

Data may be stored in internal registers and therefore may show on a given GPIO pin after the configuration is changed.

Buffer Timing

The buffer is used to isolate fast transients from the overload protection of the high-precision amplifier. It avoids current into the overload clamp. Fast transients result from the switching transient of a signal multiplexer or a gain change; these transients cannot be filtered in the signal path.

The buffer can be turned on by software using the 'T' bit in the SPI command or by activating a GPIO pin. The on-time of the buffer is set in Register 3 (BUFTIM).

If controlled by software command, the buffer turns active (indicated by BUFA shown in Figure 55) with the last falling edge of SCLK.

Controlling an external MUX through Register 0 activates the GPIO pins after the rising edge of \overline{CS} , providing an extra delay.

Alternatively, the buffer can be controlled by GPIO4, after configuration (Register 8, bit 4 = 0, and 0x4C10). A rising edge triggers the buffer with a delay of three to four clock cycles. If held high, the buffer [BUFA] remains active. It is extended by a minimum of three to four clock cycles plus FLAGTIM.

The buffer active condition can be observed at GPIO5, after configuration for output and special function (0x4820, 0x4C20). The time reference is the end of \overline{CS} . The buffer is turned on with the 16th falling edge of the SCLK and writing to Register 0 (0x6018). BUFA stays high for 6 μ s (BUFTIM0) after \overline{CS} .

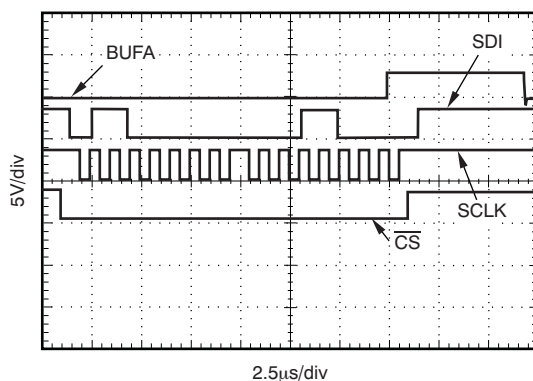

Figure 55. BUFA Timing

GPIO Operation Mode

The six GPIO port pins can be configured individually in several modes: as inputs or outputs; a special \overline{CS} mode; and a connection to the PGA280 internal special function register that contains control signals or indications. See Table 1 for details. The GPIO can be accessed through SPI as soon as supply voltage is connected to DVDD and DGND.

Input: Standard CMOS high-impedance input, no internal termination. Terminate externally if not used or set to output. **Note:** The GPIOs are all set as inputs after a device reset.

Output: Push-pull output. Output current is derived from DVDD and from DGND. Avoid I/O activity and high current during high-precision measurements to avoid coupled noise.

Special Function I/O: The configuration allows connecting a designated pin to the special function register (Register 12): OSCout, SYNCin, BUFAout, BUFTin, EFout, MUX2, MUX1, and MUX0. The pin must be configured as an input or output according to the pin function.

Example (CHKsum not enabled):

0x480B GPIO0, GPIO1, and GPIO3 set to output

0x4C0B GPIO0 and GPIO1 connected to MUX0 and MUX1, EFout connected to GPIO3. MUX0 and MUX1 are controlled from Register 0.

$\overline{\text{CS}}$ Mode

A special $\overline{\text{CS}}$ mode for the GPIO extends the device communications to other external SPI devices, such as data converters or shift registers. This $\overline{\text{CS}}$ function is intended for SPI communication using four isolation couplers. To use this mode, follow this procedure:

Configure the desired GPIO pins as outputs in Register 8, then configure the respective $\overline{\text{ECS}}$ (extended $\overline{\text{CS}}$) bits in Register 9.

Register 2 allows control of the clock mode by CPn (n for the individual $\overline{\text{ECS}}$ pins). CP = 1 asserts $\overline{\text{ECS}}$ after the last negative SCLK edge of the command; CP = 0 asserts $\overline{\text{ECS}}$ after the positive SCLK, as Figure 56 shows.

Use the $\overline{\text{CS}}$ command 1100 0cccb [ccc = $\overline{\text{CS}}$ coded for 0 to 7] to activate $\overline{\text{ECS}}$ on a single GPIO pin.

Example for $\overline{\text{ECS}}$ on pin GPIO1 (CHKsum disabled):

0x4802 GPIO1 configured output (**Note:** GPIO may output a previously stored state; default is all zeroes)

0x4902 Assign $\overline{\text{CS}}$ ($\overline{\text{ECS}}$) mode to GPIO1

0xC1 Single byte command to activate $\overline{\text{CS}}$ on GPIO1

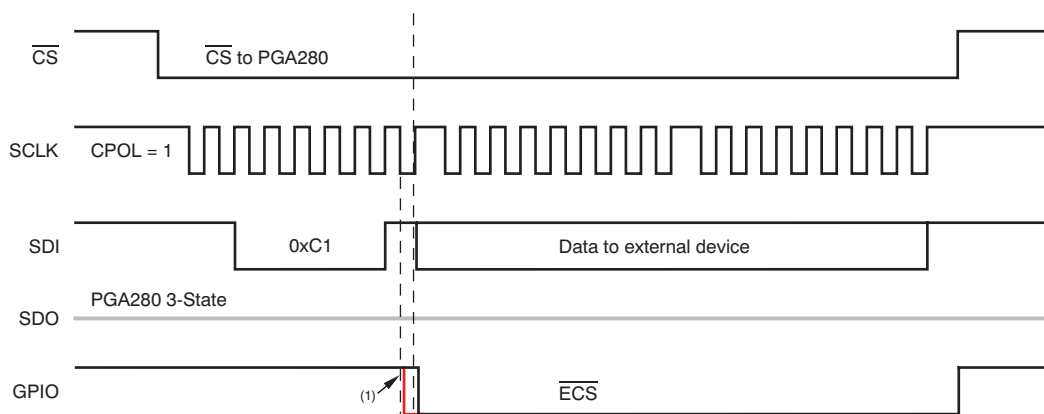

(1) CPn = 0; the red edge applies if CPn = 1.

Figure 56. Timing for GPIO Pin Acting as $\overline{\text{CS}}$ ($\overline{\text{ECS}}$) to External Device

This $\overline{\text{CS}}$ pin ($\overline{\text{ECS}}$) stays low as long as $\overline{\text{CS}}$ to the PGA280 is held low. The PGA280 SDO is turned to a high-impedance output (and requires external termination). The PGA280 ignores both clock and data signals during this time. Therefore, data can be read and written to another device selected by the $\overline{\text{ECS}}$ port. Communication is terminated by setting $\overline{\text{CS}}$ (to the PGA280) to high; this toggle also sets the port $\overline{\text{ECS}}$ to high and terminates the I/O transfer with the other device.

Figure 56 shows the timing for the GPIO-generated $\overline{\text{ECS}}$ pulse in clock mode SPOL = 1 (SCLK is high after $\overline{\text{CS}}$ asserts low). Register 2 allows activating SPOL = 0 by writing a '1' to the CP bit, according to SPI mode1. The initial setting is SPOL = 1.

Mode1; set bit to '1': a positive edge of SCLK follows after $\overline{\text{ECS}}$ asserts low (CP = 0). See the red edge of the GPIO trace in Figure 56.

Mode2; set bit to '0': a negative edge of SCLK follows after $\overline{\text{ECS}}$ asserts high (CP = 1). See the black edge of the GPIO trace in Figure 56.

The negative edge of SCLK senses data. The positive edge of SCLK sets data on the data out line (if applicable).

For SPI modes 0 or 3, SCLK must be inverted to indirectly sense data with the positive edge of SCLK. Figure 57 shows an example of connecting additional SPI devices, addressed by the $\overline{\text{ECS}}$. The OR connection for SDO can be a wired-OR if all devices provide a 3-state output option with the respective device $\overline{\text{CS}}$ ($\overline{\text{ECS}}$) set high.

The SPI interface allows clock rates higher than 10MHz. Clock rates less than 10MHz are recommended when using the $\overline{\text{ECS}}$ mode for less critical printed circuit board (PCB) layout and timing. Observe delays and distortion generated from isolation couplers. External drivers may be required to drive long and terminated cables.

With only four isolation couplers (digital galvanic isolation) connected in the SPI wires, the SPI can provide galvanic isolation for input and output channels. Figure 57 shows a block diagram of how to connect SPI devices selected by the $\overline{\text{ECS}}$ (extended $\overline{\text{CS}}$) signal.

Isolation couples or long SPI cables in harsh industrial environment are sensitive to impairments. For improved communication integrity, the communication can be extended with a checksum byte.

Figure 57 shows an example of the GPIO pins used for both the extended chip select and special functions.

The chip select ($\overline{\text{CS}}$) is connected to the PGA280 alone. The serial data input (SDI) and the serial clock (SCLK) are shared connections, and are connected to all devices [PGA280, A/D converter, and the shift register or digital-to-analog converter (DAC)]. The serial data output comes from each of the devices and are OR-connected or sent to an OR gate, to be received by the master. An OR gate is only required if the connected devices do not support 3-state operation. The PGA280 provides a 3-state output if not active. Pullup resistors may be required.

As mentioned previously, the GPIO pins are used to control an external multiplexer. In Figure 57, the three pins from GPIO0, GPIO1, and GPIO2 are used as a MUX address. Two other GPIO pins are used as $\overline{\text{ECS}}$ to enable communications with other slave devices.

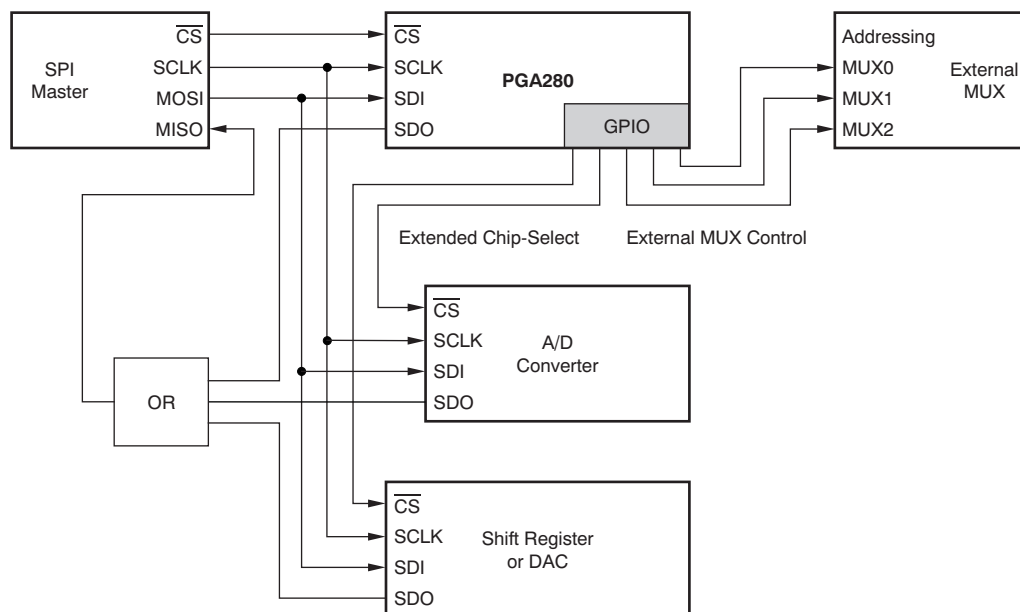

Figure 57. Example for Connecting Two Additional SPI Devices Selected by $\overline{\text{ECS}}$

Checksum

SPI communication can be secured by adding a checksum byte to the write and read data. If this mode is activated by setting CHKsumE (bit 0 in Register 11), the PGA280 expects a valid checksum; otherwise, the device ignores the received data and sets CHKerr in Register 4. This event may require a Register 4 read after each write completes. The PGA280 always responds to a read with checksum if sufficient SCLK pulses (16) are provided after the command byte.

A straight checksum (ignore carry) with a starting value of 0x9B, an 8-bit byte, is used. Polynomial value: $10011010b = 0x9B$ (b denotes binary, $0x$ denotes hex coding)

Write to device: Command byte + Data byte + CHKsum byte
 $CHKsum = \text{Polynomial value} + \text{Command byte} + \text{Data byte}^*$;

Read command to device = Command byte + CHKsum byte

Response: Data byte + CHKsum byte
 $CHKsum = \text{Polynomial value} + \text{Command byte} + \text{Data byte}$

*The command for activating the \overline{CS} on a GPIO pin (after configuration) is only a command byte: '11Tx 0ccc'.

Example: 0xC15C. This instruction activates \overline{CS} on GPIO1. The 5C is the checksum $[(0x9B + 0xC1) \bmod 0x100 = 0x5C]$

The checksum is calculated only for the communication to or from the PGA280. In extended SPI mode, if connecting the \overline{CS} (ECS) for other SPI devices to the PGA280 port, the external device has to provide its own checksum character, if available.

Examples:

0x4101DD Send Reset [CHKsum calculation: $(0x9B + 0x41 + 0x01) \bmod 0x100 = 0xDD$]
 0x4B11F7 Activate CHKsum bit 0 of Register 11. Note that activation of the CHK bit requires proper Checksum.
 0x8B260000 Read Configuration Register 11 (contains 0x11) [$0x9B + 0x8B = 0x26$]
 0x1137 Response includes the CHKsum [$0x9B + 0x8B + 0x11 = 0x37$]
 0x44FFDF Reset all error flags in Register 4 [$0x9B + 0x44 + 0xFF = 0xDF$]
 0x841F0000 Read Register 4 [$0x9B + 0x84 = 0x1F$]
 0x001F No errors indicated if 00 [$0x9B + 0x84 + 0x00 = 0x1F$]

Commands can be chained while \overline{CS} is active low; all bytes are added for checksum:

Examples:

0x4C 07 EE; Activate MUX0, MUX1, and MUX2 to GPIO0, GPIO1, and GPIO2, respectively
 0x64 FF FE 40 1B 59 80 D9 00 00; Write to Register 4 with BUF trigger and reset all error flags
 : Write to Register 0 and set gain 1V/V; MUX0 and MUX1 set high
 : Read Register 0, provide 16 SCLKs

PACKAGING INFORMATION

Orderable Device	Status ⁽¹⁾	Package Type	Package Drawing	Pins	Package Qty	Eco Plan ⁽²⁾	Lead/Ball Finish	MSL Peak Temp ⁽³⁾
PGA280AIPW	ACTIVE	TSSOP	PW	24	60	Green (RoHS & no Sb/Br)	CU NIPDAU	Level-2-260C-1 YEAR
PGA280AIPWR	ACTIVE	TSSOP	PW	24	2000	Green (RoHS & no Sb/Br)	CU NIPDAU	Level-2-260C-1 YEAR

⁽¹⁾ The marketing status values are defined as follows:

ACTIVE: Product device recommended for new designs.

LIFEBUY: TI has announced that the device will be discontinued, and a lifetime-buy period is in effect.

NRND: Not recommended for new designs. Device is in production to support existing customers, but TI does not recommend using this part in a new design.

PREVIEW: Device has been announced but is not in production. Samples may or may not be available.

OBsolete: TI has discontinued the production of the device.

⁽²⁾ Eco Plan - The planned eco-friendly classification: Pb-Free (RoHS), Pb-Free (RoHS Exempt), or Green (RoHS & no Sb/Br) - please check <http://www.ti.com/productcontent> for the latest availability information and additional product content details.

TBD: The Pb-Free/Green conversion plan has not been defined.

Pb-Free (RoHS): TI's terms "Lead-Free" or "Pb-Free" mean semiconductor products that are compatible with the current RoHS requirements for all 6 substances, including the requirement that lead not exceed 0.1% by weight in homogeneous materials. Where designed to be soldered at high temperatures, TI Pb-Free products are suitable for use in specified lead-free processes.

Pb-Free (RoHS Exempt): This component has a RoHS exemption for either 1) lead-based flip-chip solder bumps used between the die and package, or 2) lead-based die adhesive used between the die and leadframe. The component is otherwise considered Pb-Free (RoHS compatible) as defined above.

Green (RoHS & no Sb/Br): TI defines "Green" to mean Pb-Free (RoHS compatible), and free of Bromine (Br) and Antimony (Sb) based flame retardants (Br or Sb do not exceed 0.1% by weight in homogeneous material)

⁽³⁾ MSL, Peak Temp. -- The Moisture Sensitivity Level rating according to the JEDEC industry standard classifications, and peak solder temperature.

Important Information and Disclaimer: The information provided on this page represents TI's knowledge and belief as of the date that it is provided. TI bases its knowledge and belief on information provided by third parties, and makes no representation or warranty as to the accuracy of such information. Efforts are underway to better integrate information from third parties. TI has taken and continues to take reasonable steps to provide representative and accurate information but may not have conducted destructive testing or chemical analysis on incoming materials and chemicals. TI and TI suppliers consider certain information to be proprietary, and thus CAS numbers and other limited information may not be available for release.

In no event shall TI's liability arising out of such information exceed the total purchase price of the TI part(s) at issue in this document sold by TI to Customer on an annual basis.

TAPE AND REEL INFORMATION

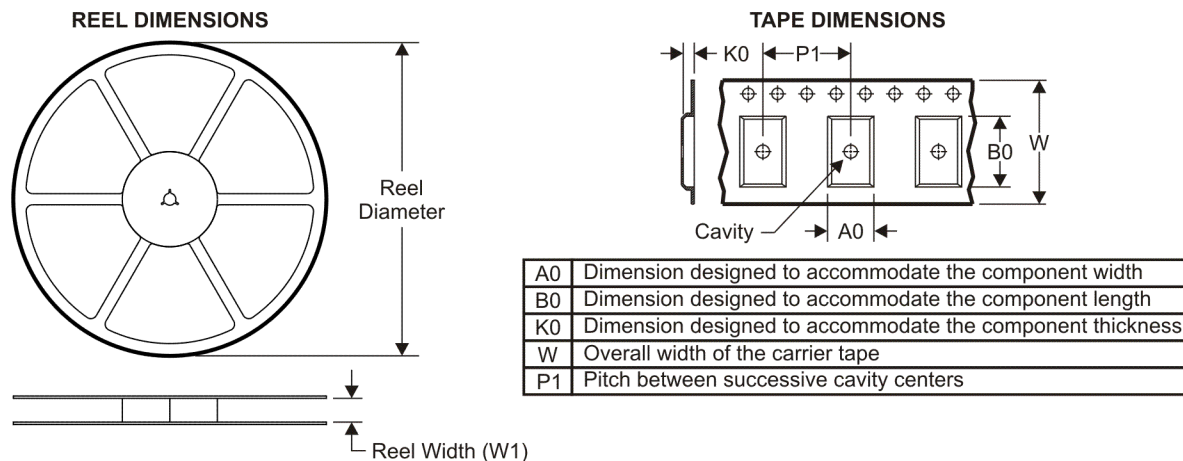

QUADRANT ASSIGNMENTS FOR PIN 1 ORIENTATION IN TAPE



*All dimensions are nominal

Device	Package Type	Package Drawing	Pins	SPQ	Reel Diameter (mm)	Reel Width W1 (mm)	A0 (mm)	B0 (mm)	K0 (mm)	P1 (mm)	W (mm)	Pin1 Quadrant
PGA280AIPWR	TSSOP	PW	24	2000	330.0	16.4	6.95	8.3	1.6	8.0	16.0	Q1

TAPE AND REEL BOX DIMENSIONS



*All dimensions are nominal

Device	Package Type	Package Drawing	Pins	SPQ	Length (mm)	Width (mm)	Height (mm)
PGA280AIPWR	TSSOP	PW	24	2000	346.0	346.0	33.0

PW (R-PDSO-G**)

PLASTIC SMALL-OUTLINE PACKAGE

14 PINS SHOWN

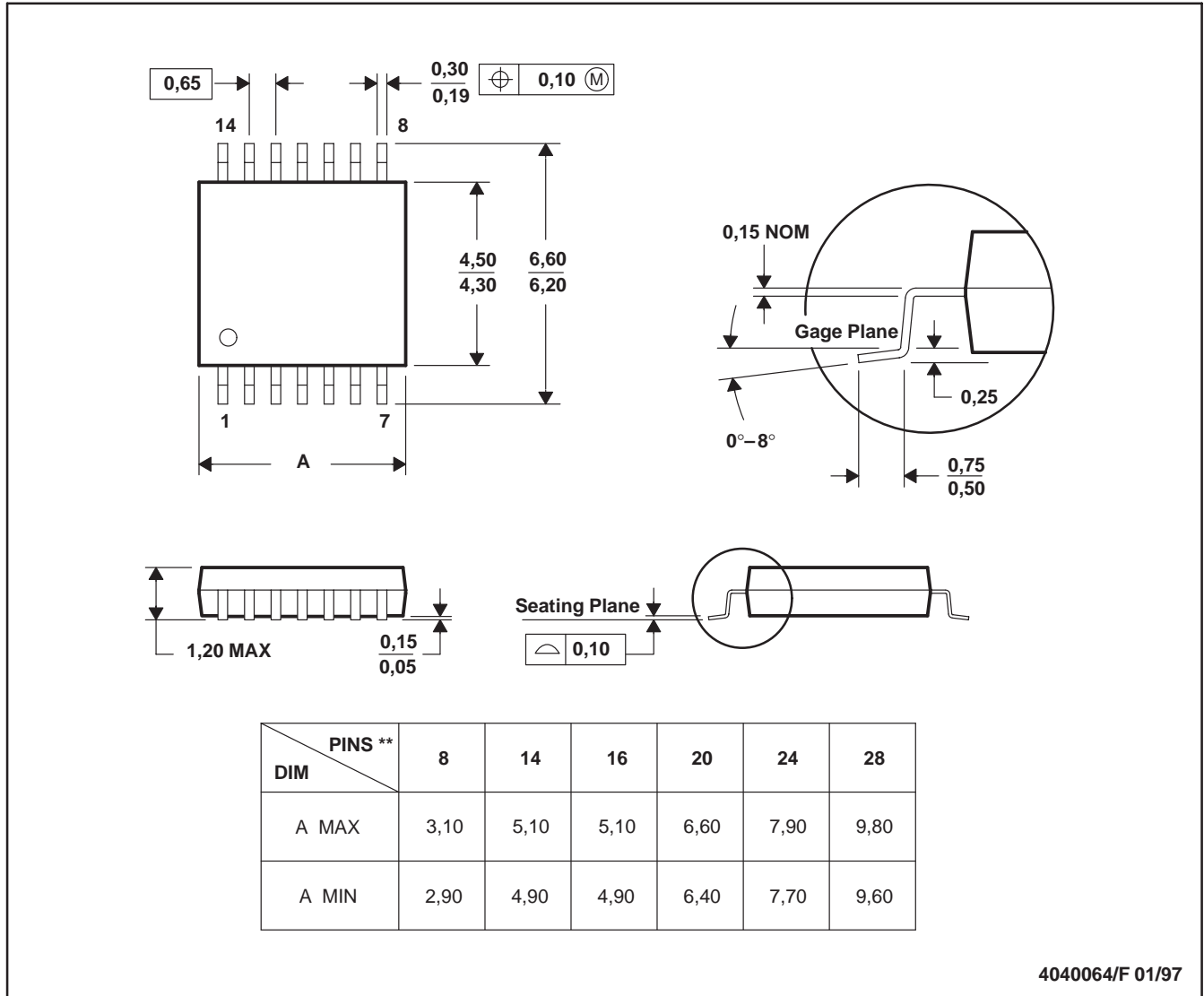

- NOTES: A. All linear dimensions are in millimeters.
 B. This drawing is subject to change without notice.
 C. Body dimensions do not include mold flash or protrusion not to exceed 0,15.
 D. Falls within JEDEC MO-153

IMPORTANT NOTICE

Texas Instruments Incorporated and its subsidiaries (TI) reserve the right to make corrections, modifications, enhancements, improvements, and other changes to its products and services at any time and to discontinue any product or service without notice. Customers should obtain the latest relevant information before placing orders and should verify that such information is current and complete. All products are sold subject to TI's terms and conditions of sale supplied at the time of order acknowledgment.

TI warrants performance of its hardware products to the specifications applicable at the time of sale in accordance with TI's standard warranty. Testing and other quality control techniques are used to the extent TI deems necessary to support this warranty. Except where mandated by government requirements, testing of all parameters of each product is not necessarily performed.

TI assumes no liability for applications assistance or customer product design. Customers are responsible for their products and applications using TI components. To minimize the risks associated with customer products and applications, customers should provide adequate design and operating safeguards.

TI does not warrant or represent that any license, either express or implied, is granted under any TI patent right, copyright, mask work right, or other TI intellectual property right relating to any combination, machine, or process in which TI products or services are used. Information published by TI regarding third-party products or services does not constitute a license from TI to use such products or services or a warranty or endorsement thereof. Use of such information may require a license from a third party under the patents or other intellectual property of the third party, or a license from TI under the patents or other intellectual property of TI.

Reproduction of TI information in TI data books or data sheets is permissible only if reproduction is without alteration and is accompanied by all associated warranties, conditions, limitations, and notices. Reproduction of this information with alteration is an unfair and deceptive business practice. TI is not responsible or liable for such altered documentation. Information of third parties may be subject to additional restrictions.

Resale of TI products or services with statements different from or beyond the parameters stated by TI for that product or service voids all express and any implied warranties for the associated TI product or service and is an unfair and deceptive business practice. TI is not responsible or liable for any such statements.

TI products are not authorized for use in safety-critical applications (such as life support) where a failure of the TI product would reasonably be expected to cause severe personal injury or death, unless officers of the parties have executed an agreement specifically governing such use. Buyers represent that they have all necessary expertise in the safety and regulatory ramifications of their applications, and acknowledge and agree that they are solely responsible for all legal, regulatory and safety-related requirements concerning their products and any use of TI products in such safety-critical applications, notwithstanding any applications-related information or support that may be provided by TI. Further, Buyers must fully indemnify TI and its representatives against any damages arising out of the use of TI products in such safety-critical applications.

TI products are neither designed nor intended for use in military/aerospace applications or environments unless the TI products are specifically designated by TI as military-grade or "enhanced plastic." Only products designated by TI as military-grade meet military specifications. Buyers acknowledge and agree that any such use of TI products which TI has not designated as military-grade is solely at the Buyer's risk, and that they are solely responsible for compliance with all legal and regulatory requirements in connection with such use.

TI products are neither designed nor intended for use in automotive applications or environments unless the specific TI products are designated by TI as compliant with ISO/TS 16949 requirements. Buyers acknowledge and agree that, if they use any non-designated products in automotive applications, TI will not be responsible for any failure to meet such requirements.

Following are URLs where you can obtain information on other Texas Instruments products and application solutions:

Products		Applications	
Amplifiers	amplifier.ti.com	Audio	www.ti.com/audio
Data Converters	dataconverter.ti.com	Automotive	www.ti.com/automotive
DLP® Products	www.dlp.com	Communications and Telecom	www.ti.com/communications
DSP	dsp.ti.com	Computers and Peripherals	www.ti.com/computers
Clocks and Timers	www.ti.com/clocks	Consumer Electronics	www.ti.com/consumer-apps
Interface	interface.ti.com	Energy	www.ti.com/energy
Logic	logic.ti.com	Industrial	www.ti.com/industrial
Power Mgmt	power.ti.com	Medical	www.ti.com/medical
Microcontrollers	microcontroller.ti.com	Security	www.ti.com/security
RFID	www.ti-rfid.com	Space, Avionics & Defense	www.ti.com/space-avionics-defense
RF/IF and ZigBee® Solutions	www.ti.com/lprf	Video and Imaging	www.ti.com/video
		Wireless	www.ti.com/wireless-apps