

# RF Power Field Effect Transistor

## N-Channel Enhancement-Mode Lateral MOSFET

Designed for broadband commercial and industrial applications with frequencies up to 1000 MHz. The high gain and broadband performance of this device makes it ideal for large-signal, common-source amplifier applications in 28 Volt base station equipment.

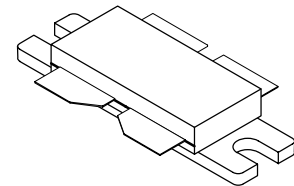
- Typical Single-Carrier N-CDMA Performance @ 880 MHz:  $V_{DD} = 28$  Volts,  $I_{DQ} = 1600$  mA,  $P_{out} = 47$  Watts Avg., IS-95 CDMA (Pilot, Sync, Paging, Traffic Codes 8 Through 13). Channel Bandwidth = 1.2288 MHz. PAR = 9.8 dB @ 0.01% Probability on CCDF.  
 Power Gain — 20 dB  
 Drain Efficiency — 30%  
 ACPR @ 750 kHz Offset — -46 dBc in 30 kHz Bandwidth
- Capable of Handling 10:1 VSWR, @ 32 Vdc, 880 MHz, 350 Watts CW Output Power (2 dB Input Overdrive from Rated  $P_{out}$ ), Designed for Enhanced Ruggedness
- Typical  $P_{out}$  @ 1 dB Compression Point  $\approx$  220 Watts CW

### Features

- Characterized with Series Equivalent Large-Signal Impedance Parameters
- Internally Matched for Ease of Use
- Device Designed for Push-Pull Operation Only
- Qualified Up to a Maximum of 32  $V_{DD}$  Operation
- Integrated ESD Protection
- RoHS Compliant
- In Tape and Reel. R3 Suffix = 250 Units per 56 mm, 13 inch Reel.

**MRFE6P9220HR3**

**865-900 MHz, 47 W AVG., 28 V  
SINGLE N-CDMA  
LATERAL N-CHANNEL  
RF POWER MOSFET**



**CASE 375G-04, STYLE 1  
NI-860C3**

**Table 1. Maximum Ratings**

Rating	Symbol	Value	Unit
Drain-Source Voltage	$V_{DSS}$	-0.5, +66	Vdc
Gate-Source Voltage	$V_{GS}$	-0.5, +12	Vdc
Storage Temperature Range	$T_{stg}$	- 65 to +150	°C
Case Operating Temperature	$T_C$	150	°C
Operating Junction Temperature (1,2)	$T_J$	225	°C

**Table 2. Thermal Characteristics**

Characteristic	Symbol	Value (2,3)	Unit
Thermal Resistance, Junction to Case Case Temperature 80°C, 220 W CW Case Temperature 76°C, 47 W CW	$R_{\theta JC}$	0.25 0.28	°C/W

1. Continuous use at maximum temperature will affect MTTF.
2. MTTF calculator available at <http://www.freescale.com/rf>. Select Software & Tools/Development Tools/Calculators to access MTTF calculators by product.
3. Refer to AN1955, *Thermal Measurement Methodology of RF Power Amplifiers*. Go to <http://www.freescale.com/rf>. Select Documentation/Application Notes - AN1955.

**Table 3. ESD Protection Characteristics**

Test Methodology	Class
Human Body Model (per JESD22-A114)	3B (Minimum)
Machine Model (per EIA/JESD22-A115)	C (Minimum)
Charge Device Model (per JESD22-C101)	IV (Minimum)

**Table 4. Electrical Characteristics** ( $T_C = 25^\circ\text{C}$  unless otherwise noted)

Characteristic	Symbol	Min	Typ	Max	Unit
<b>Off Characteristics</b>					
Zero Gate Voltage Drain Leakage Current <sup>(4)</sup> ( $V_{DS} = 66\text{ Vdc}$ , $V_{GS} = 0\text{ Vdc}$ )	$I_{DSS}$	—	—	10	$\mu\text{Adc}$
Zero Gate Voltage Drain Leakage Current <sup>(4)</sup> ( $V_{DS} = 28\text{ Vdc}$ , $V_{GS} = 0\text{ Vdc}$ )	$I_{DSS}$	—	—	1	$\mu\text{Adc}$
Gate-Source Leakage Current <sup>(1)</sup> ( $V_{GS} = 5\text{ Vdc}$ , $V_{DS} = 0\text{ Vdc}$ )	$I_{GSS}$	—	—	1	$\mu\text{Adc}$

**On Characteristics**

Gate Threshold Voltage <sup>(1)</sup> ( $V_{DS} = 10\text{ Vdc}$ , $I_D = 240\ \mu\text{Adc}$ )	$V_{GS(th)}$	1.5	2.2	3	Vdc
Gate Quiescent Voltage <sup>(3)</sup> ( $V_{DD} = 28\text{ Vdc}$ , $I_D = 1600\text{ mAdc}$ , Measured in Functional Test)	$V_{GS(Q)}$	2.3	3	3.8	Vdc
Drain-Source On-Voltage <sup>(1)</sup> ( $V_{GS} = 10\text{ Vdc}$ , $I_D = 2.4\text{ Adc}$ )	$V_{DS(on)}$	0.1	0.22	0.3	Vdc

**Dynamic Characteristics <sup>(2)</sup>**

Reverse Transfer Capacitance <sup>(4)</sup> ( $V_{DS} = 28\text{ Vdc} \pm 30\text{ mV(rms)ac}$ @ 1 MHz, $V_{GS} = 0\text{ Vdc}$ )	$C_{rss}$	—	1.22	—	pF
Output Capacitance <sup>(4)</sup> ( $V_{DS} = 28\text{ Vdc} \pm 30\text{ mV(rms)ac}$ @ 1 MHz, $V_{GS} = 0\text{ Vdc}$ )	$C_{oss}$	—	217	—	pF
Input Capacitance ( $V_{DS} = 28\text{ Vdc}$ , $V_{GS} = 0\text{ Vdc} \pm 30\text{ mV(rms)ac}$ @ 1 MHz)	$C_{iss}$	—	1060	—	pF

**Functional Tests <sup>(3)</sup>** (In Freescale Test Fixture, 50 ohm system)  $V_{DD} = 28\text{ Vdc}$ ,  $I_{DQ} = 1600\text{ mA}$ ,  $P_{out} = 47\text{ W Avg. N-CDMA}$ ,  $f = 880\text{ MHz}$ , Single-Carrier N-CDMA, 1.2288 MHz Channel Bandwidth Carrier. ACPR measured in 30 kHz Channel Bandwidth @  $\pm 750\text{ kHz}$  Offset. PAR = 9.8 dB @ 0.01% Probability on CCDF.

Power Gain	$G_{ps}$	18.5	20	23	dB
Drain Efficiency	$\eta_D$	28	30	—	%
Adjacent Channel Power Ratio	ACPR	—	-46	-44.5	dBc
Input Return Loss	IRL	—	-14	-9	dB

1. Each side of the device measured separately.
2. Part internally matched both on input and output.
3. Measurement made with device in push-pull configuration.
4. Drains are tied together internally as this is a total device value.

(continued)

**Table 4. Electrical Characteristics** ( $T_C = 25^\circ\text{C}$  unless otherwise noted) (continued)

Characteristic	Symbol	Min	Typ	Max	Unit
<b>Typical Performances</b> (In Freescale Test Fixture, 50 ohm system) $V_{DD} = 28 \text{ Vdc}$ , $I_{DQ} = 1600 \text{ mA}$ , 850-910 MHz Bandwidth					
$P_{out}$ @ 1 dB Compression Point, CW	P1dB	—	220	—	W
IMD Symmetry @ 220 W PEP, $P_{out}$ where IMD Third Order Intermodulation $\cong 30 \text{ dBc}$ (Delta IMD Third Order Intermodulation between Upper and Lower Sidebands > 2 dB)	IMD <sub>sym</sub>	—	10	—	MHz
VBW Resonance Point (IMD Third Order Intermodulation Inflection Point)	VBW <sub>res</sub>	—	35	—	MHz
Gain Flatness in 60 MHz Bandwidth @ $P_{out} = 47 \text{ W Avg.}$	G <sub>F</sub>	—	1.1	—	dB
Average Deviation from Linear Phase in 60 MHz Bandwidth @ $P_{out} = 220 \text{ W CW}$	$\Phi$	—	3.1	—	°
Average Group Delay @ $P_{out} = 220 \text{ W CW}$ , $f = 880 \text{ MHz}$	Delay	—	4.6	—	ns
Part-to-Part Insertion Phase Variation @ $P_{out} = 220 \text{ W CW}$ , $f = 880 \text{ MHz}$ , Six Sigma Window	$\Delta\Phi$	—	11	—	°
Gain Variation over Temperature (-30°C to +85°C)	$\Delta G$	—	0.012	—	dB/°C
Output Power Variation over Temperature (-30°C to +85°C)	$\Delta P_{1dB}$	—	0.005	—	dBm/°C



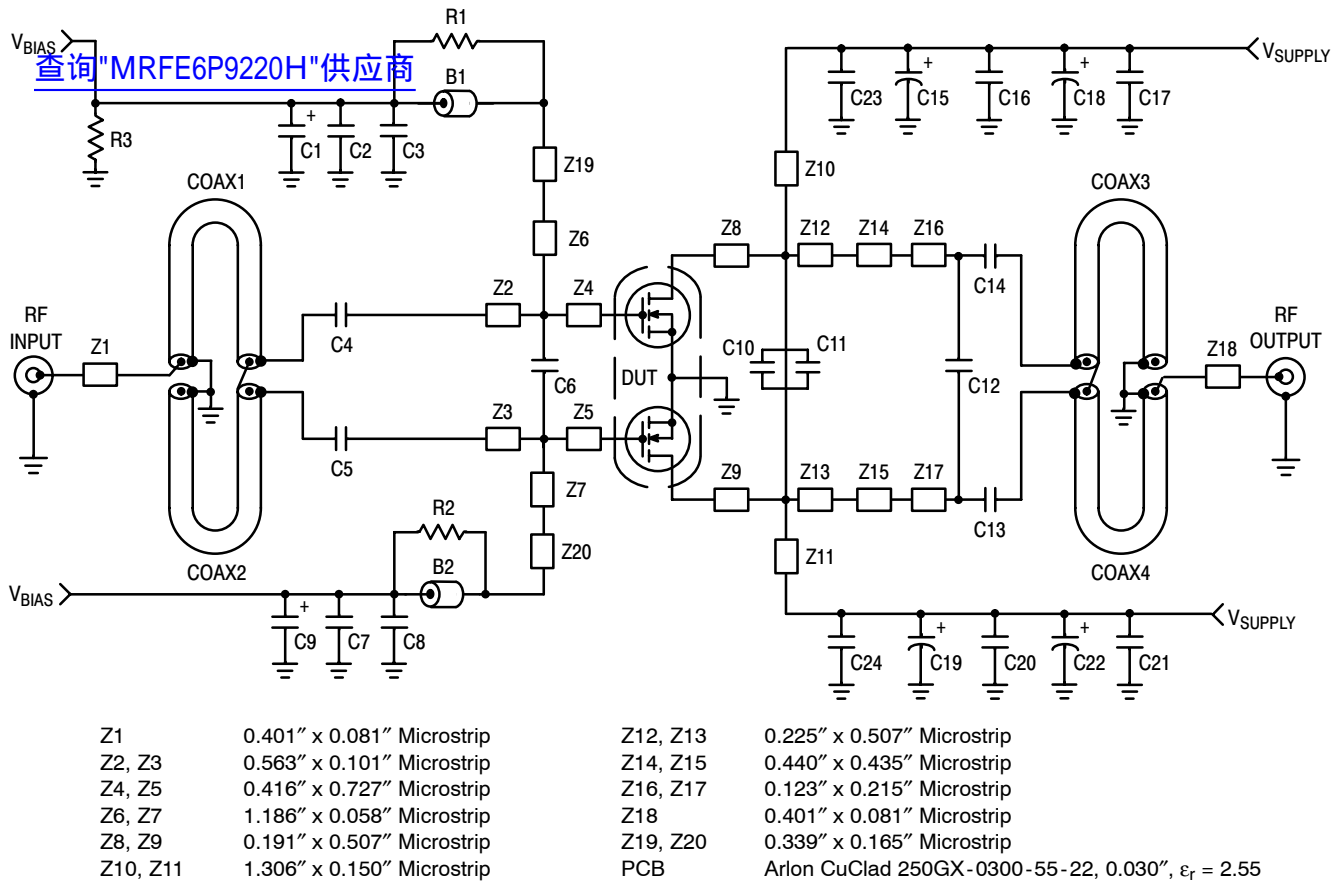


Figure 1. MRF6P9220HR3 Test Circuit Schematic

Table 5. MRF6P9220HR3 Test Circuit Component Designations and Values

Part	Description	Part Number	Manufacturer
B1, B2	Ferrite Beads, Short	2743019447	Fair-Rite
C1, C9	1.0 $\mu$ F, 50 V Tantalum Chip Capacitors	T491C105K050AT	Kemet
C2, C7, C17, C21	0.1 $\mu$ F Chip Capacitors	CDR33BX104AKWT	Kemet
C3, C8, C16, C20	1000 pF Chip Capacitors	ATC100B102JT50XT	ATC
C4, C5, C13, C14	100 pF Chip Capacitors	ATC100B101JT500XT	ATC
C6, C12	8.2 pF Chip Capacitors	ATC100B8R2BT500XT	ATC
C10	9.1 pF Chip Capacitor	ATC100B9R1BT500XT	ATC
C11	1.8 pF Chip Capacitor	ATC100B1R8BT500XT	ATC
C15, C19	47 $\mu$ F, 50 V Electrolytic Capacitors	EMVY500ADA470MF80G	Nippon Chemi-Con
C18, C22	470 $\mu$ F, 63 V Electrolytic Capacitors	EMVY630GTR471MLN0S	Nippon Chemi-Con
C23, C24	22 pF Chip Capacitors	ATC100B220FT500XT	ATC
Coax1, 2, 3, 4	50 $\Omega$ , Semi Rigid Coax, 2.40" Long	UT-141A-TP	Micro-Coax
R1, R2	10 $\Omega$ , 1/4 W Chip Resistors	CRCW120610R0FKEA	Vishay
R3	1.0 k $\Omega$ , 1/4 W Chip Resistor	CRCW12061001FKEA	Vishay

查询"MRFE6P9220H"供应商

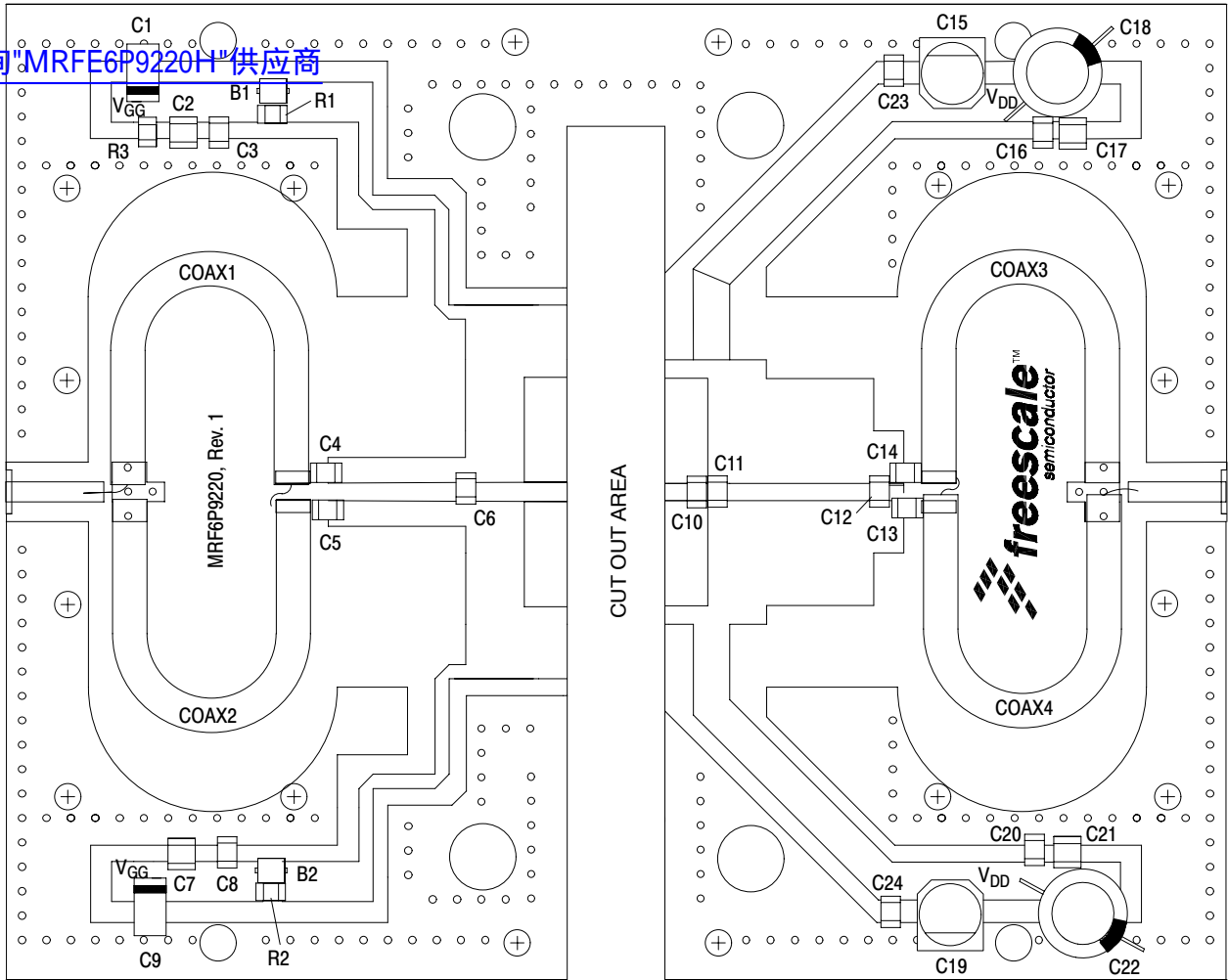


Figure 2. MRF6P9220HR3 Test Circuit Component Layout



## TYPICAL CHARACTERISTICS

查询"MRFE6P9220H"供应商

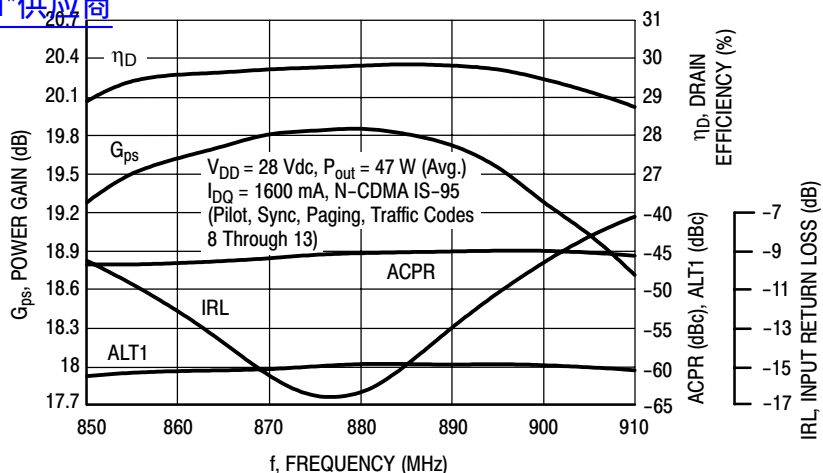


Figure 3. Single-Carrier N-CDMA Broadband Performance @  $P_{out} = 47$  Watts Avg.

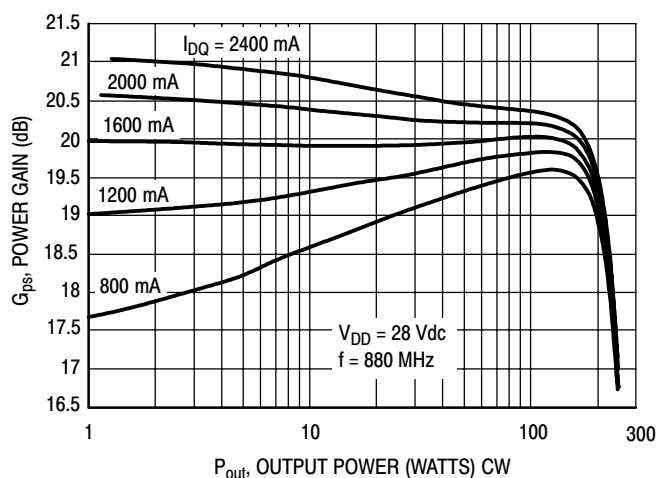


Figure 4. CW Power Gain versus Output Power

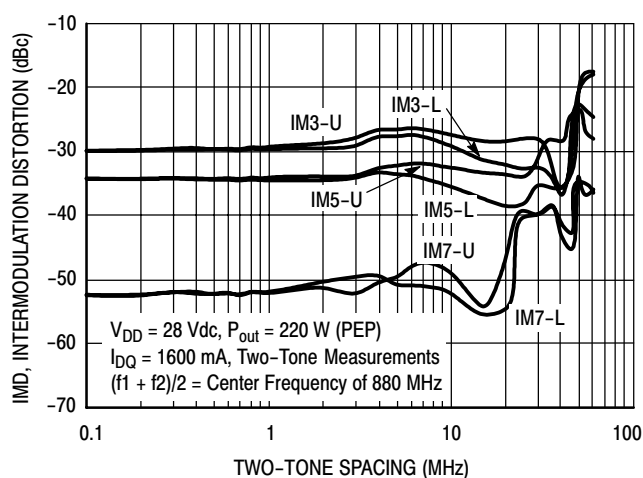


Figure 5. Intermodulation Distortion Products versus Tone Spacing

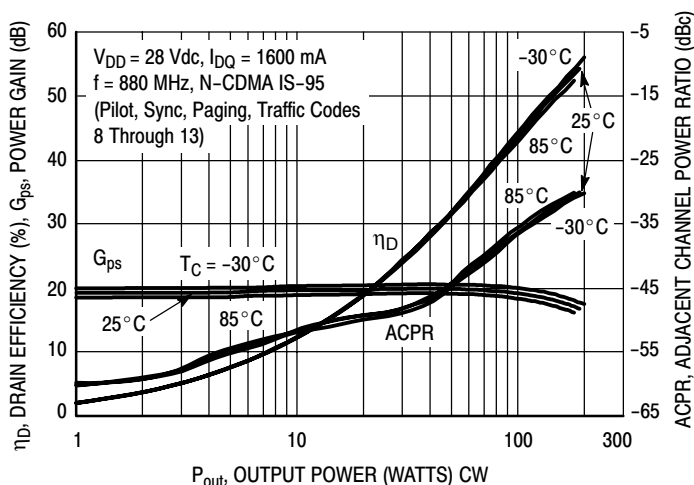
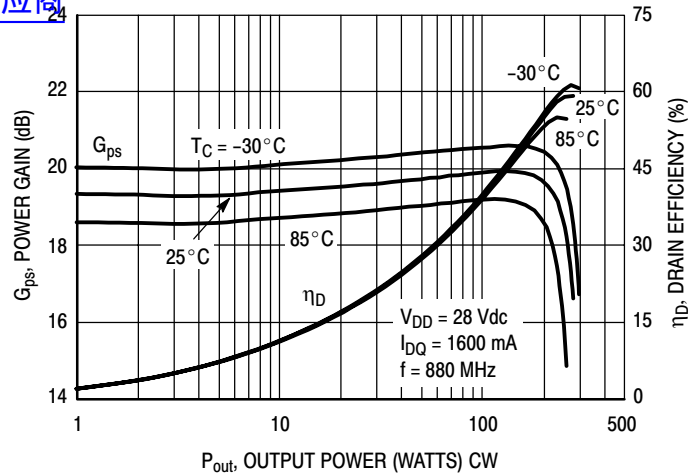


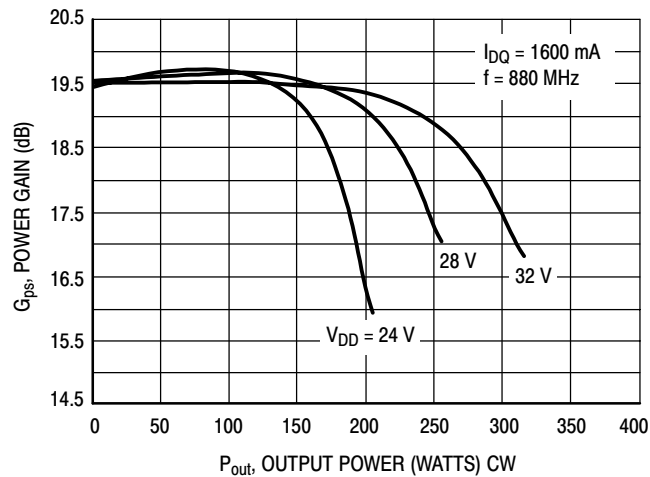
Figure 6. Single-Carrier N-CDMA ACPR, Power Gain and Drain Efficiency versus Output Power

## TYPICAL CHARACTERISTICS

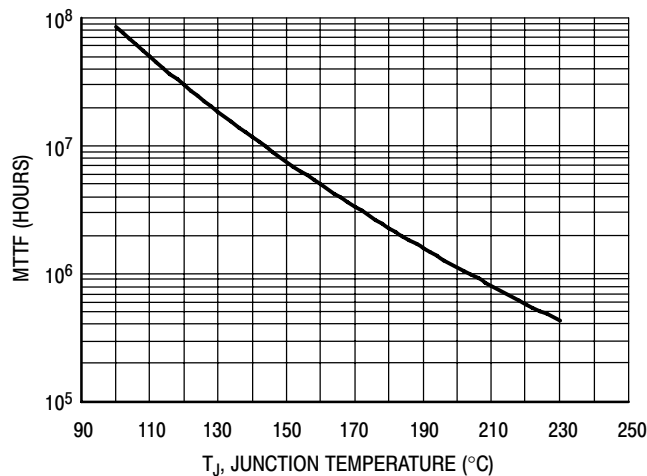
查询"MRFE6P9220H"供应商



**Figure 7. Power Gain and Drain Efficiency versus CW Output Power**



**Figure 8. Power Gain versus Output Power**



This above graph displays calculated MTF in hours when the device is operated at  $V_{DD} = 28$  Vdc,  $P_{out} = 47$  W Avg., and  $\eta_D = 30\%$ .

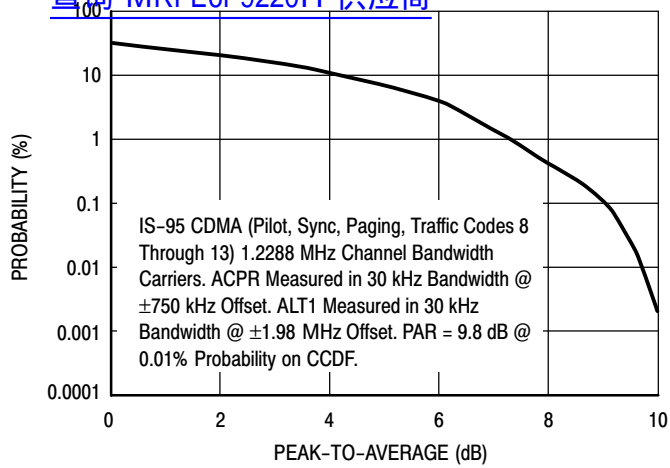
MTF calculator available at <http://www.freescale.com/rf>. Select Software & Tools/Development Tools/Calculators to access MTF calculators by product.

**Figure 9. MTF Factor versus Junction Temperature**

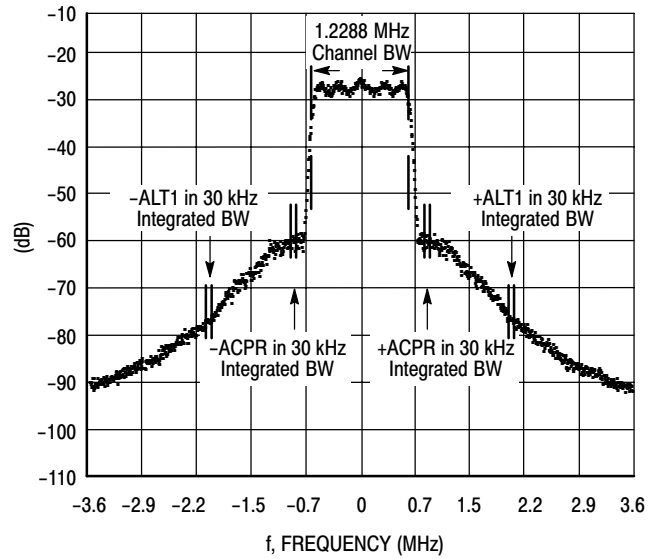


## N-CDMA TEST SIGNAL

查询"MRFE6P9220H"供应商

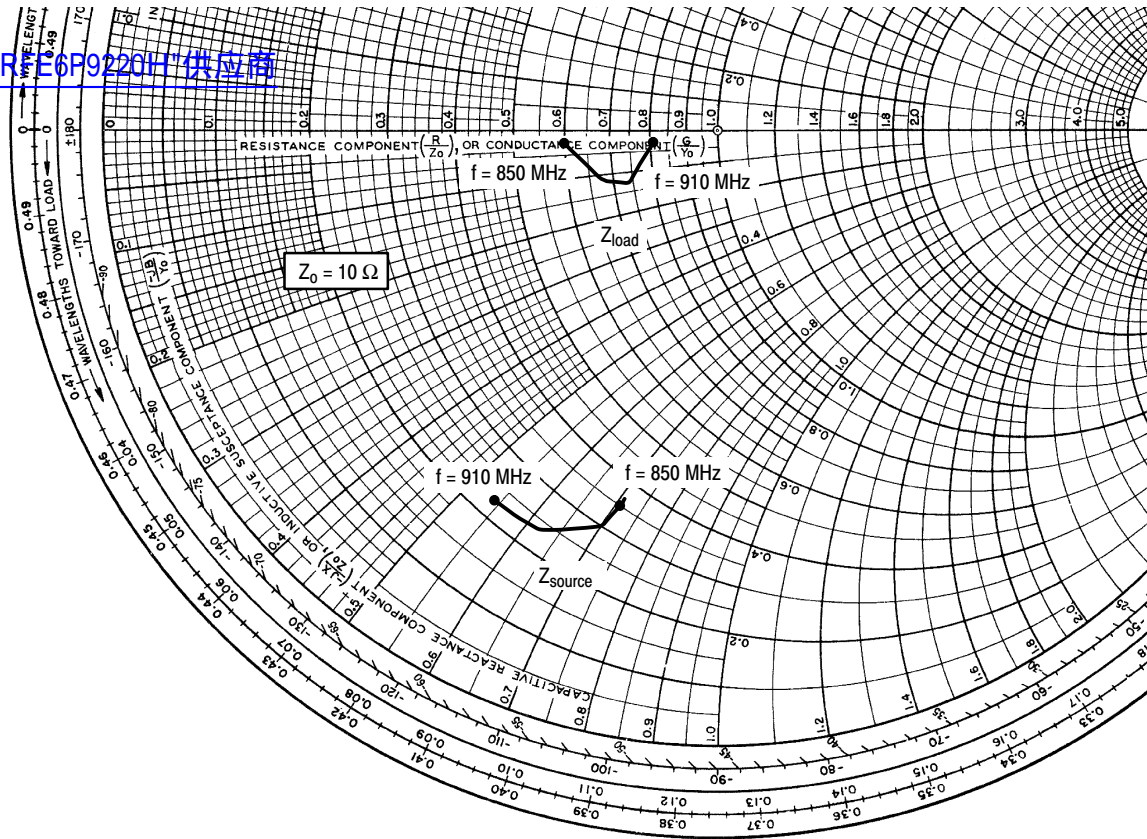


**Figure 10. Single-Carrier CCDF N-CDMA**



**Figure 11. Single-Carrier N-CDMA Spectrum**





$V_{DD} = 28 \text{ Vdc}$ ,  $I_{DQ} = 1600 \text{ mA}$ ,  $P_{out} = 47 \text{ W Avg.}$

f MHz	$Z_{source}$ $\Omega$	$Z_{load}$ $\Omega$
850	$3.50 - j7.10$	$6.04 - j0.49$
865	$3.59 - j7.07$	$6.83 - j1.14$
880	$3.03 - j6.98$	$7.41 - j1.19$
895	$2.42 - j6.20$	$7.60 - j0.98$
910	$2.26 - j5.39$	$8.06 - j0.45$

$Z_{source}$  = Test circuit impedance as measured from gate to gate, balanced configuration.

$Z_{load}$  = Test circuit impedance as measured from drain to drain, balanced configuration.

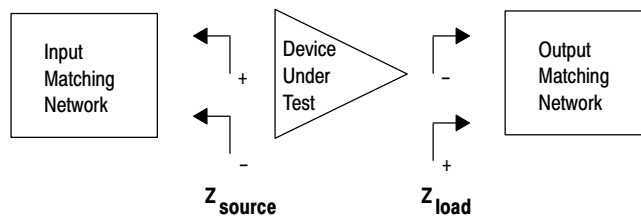
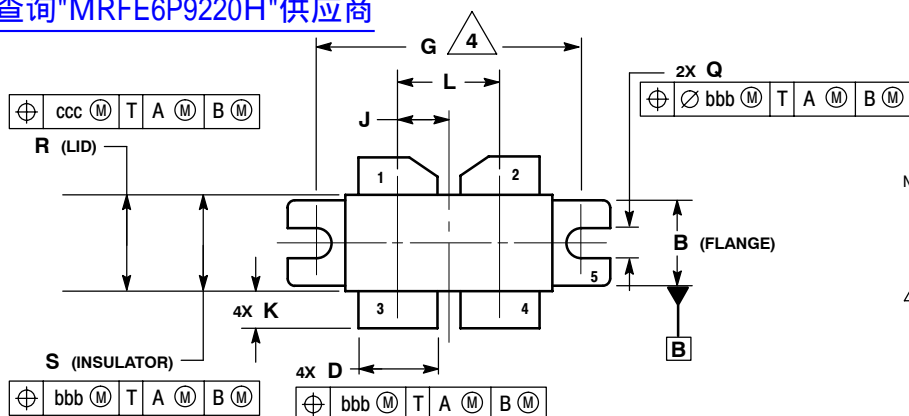


Figure 12. Series Equivalent Source and Load Impedance

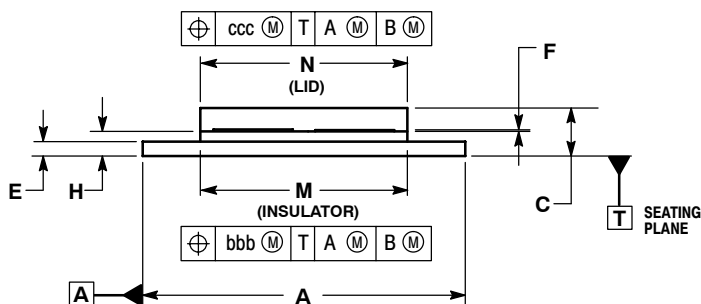
# PACKAGE DIMENSIONS

查询"MRFE6P9220H"供应商



- NOTES:
1. CONTROLLING DIMENSION: INCH.
  2. INTERPRET DIMENSIONS AND TOLERANCES PER ASME Y14.5M-1994.
  3. DIMENSION H TO BE MEASURED 0.030 (0.762) AWAY FROM PACKAGE BODY.
  4. RECOMMENDED BOLT CENTER DIMENSION OF 1.140 (28.96) BASED ON 3M SCREW.

DIM	INCHES		MILLIMETERS	
	MIN	MAX	MIN	MAX
A	1.335	1.345	33.91	34.16
B	0.380	0.390	9.65	9.91
C	0.180	0.224	4.57	5.69
D	0.325	0.335	8.26	8.51
E	0.060	0.070	1.52	1.78
F	0.004	0.006	0.10	0.15
G	1.100 BSC		27.94 BSC	
H	0.097	0.107	2.46	2.72
J	0.2125 BSC		5.397 BSC	
K	0.135	0.165	3.43	4.19
L	0.425 BSC		10.8 BSC	
M	0.852	0.868	21.64	22.05
N	0.851	0.869	21.62	22.07
Q	0.118	0.138	3.00	3.30
R	0.395	0.405	10.03	10.29
S	0.394	0.406	10.01	10.31
bbb	0.010 REF		0.25 REF	
ccc	0.015 REF		0.38 REF	



- STYLE 1:  
 PIN 1: DRAIN  
 2: DRAIN  
 3: GATE  
 4: GATE  
 5: SOURCE

CASE 375G-04  
 ISSUE G  
 NI-860C3

## PRODUCT DOCUMENTATION

[查询"MRF6P9220H"供应商](#)

Refer to the following documents to aid your design process.

### Application Notes

- AN1955: Thermal Measurement Methodology of RF Power Amplifiers

### Engineering Bulletins

- EB212: Using Data Sheet Impedances for RF LDMOS Devices

## REVISION HISTORY

The following table summarizes revisions to this document.

Revision	Date	Description
0	Jan. 2009	<ul style="list-style-type: none"><li>• Initial Release of Data Sheet</li></ul>



## [查询"MRFE6P9220H"供应商](#)

### **How to Reach Us:**

#### **Home Page:**

[www.freescale.com](http://www.freescale.com)

#### **Web Support:**

<http://www.freescale.com/support>

#### **USA/Europe or Locations Not Listed:**

Freescale Semiconductor, Inc.  
Technical Information Center, EL516  
2100 East Elliot Road  
Tempe, Arizona 85284  
1-800-521-6274 or +1-480-768-2130  
[www.freescale.com/support](http://www.freescale.com/support)

#### **Europe, Middle East, and Africa:**

Freescale Halbleiter Deutschland GmbH  
Technical Information Center  
Schatzbogen 7  
81829 Muenchen, Germany  
+44 1296 380 456 (English)  
+46 8 52200080 (English)  
+49 89 92103 559 (German)  
+33 1 69 35 48 48 (French)  
[www.freescale.com/support](http://www.freescale.com/support)

#### **Japan:**

Freescale Semiconductor Japan Ltd.  
Headquarters  
ARCO Tower 15F  
1-8-1, Shimo-Meguro, Meguro-ku,  
Tokyo 153-0064  
Japan  
0120 191014 or +81 3 5437 9125  
[support.japan@freescale.com](mailto:support.japan@freescale.com)

#### **Asia/Pacific:**

Freescale Semiconductor China Ltd.  
Exchange Building 23F  
No. 118 Jianguo Road  
Chaoyang District  
Beijing 100022  
China  
+86 10 5879 8000  
[support.asia@freescale.com](mailto:support.asia@freescale.com)

#### **For Literature Requests Only:**

Freescale Semiconductor Literature Distribution Center  
P.O. Box 5405  
Denver, Colorado 80217  
1-800-441-2447 or +1-303-675-2140  
Fax: +1-303-675-2150  
[LDCForFreescaleSemiconductor@hibbertgroup.com](mailto:LDCForFreescaleSemiconductor@hibbertgroup.com)

Information in this document is provided solely to enable system and software implementers to use Freescale Semiconductor products. There are no express or implied copyright licenses granted hereunder to design or fabricate any integrated circuits or integrated circuits based on the information in this document.

Freescale Semiconductor reserves the right to make changes without further notice to any products herein. Freescale Semiconductor makes no warranty, representation or guarantee regarding the suitability of its products for any particular purpose, nor does Freescale Semiconductor assume any liability arising out of the application or use of any product or circuit, and specifically disclaims any and all liability, including without limitation consequential or incidental damages. "Typical" parameters that may be provided in Freescale Semiconductor data sheets and/or specifications can and do vary in different applications and actual performance may vary over time. All operating parameters, including "Typicals", must be validated for each customer application by customer's technical experts. Freescale Semiconductor does not convey any license under its patent rights nor the rights of others. Freescale Semiconductor products are not designed, intended, or authorized for use as components in systems intended for surgical implant into the body, or other applications intended to support or sustain life, or for any other application in which the failure of the Freescale Semiconductor product could create a situation where personal injury or death may occur. Should Buyer purchase or use Freescale Semiconductor products for any such unintended or unauthorized application, Buyer shall indemnify and hold Freescale Semiconductor and its officers, employees, subsidiaries, affiliates, and distributors harmless against all claims, costs, damages, and expenses, and reasonable attorney fees arising out of, directly or indirectly, any claim of personal injury or death associated with such unintended or unauthorized use, even if such claim alleges that Freescale Semiconductor was negligent regarding the design or manufacture of the part.

Freescale™ and the Freescale logo are trademarks of Freescale Semiconductor, Inc. All other product or service names are the property of their respective owners.

© Freescale Semiconductor, Inc. 2009. All rights reserved.

