

MOS FIELD EFFECT TRANSISTOR

NP22N055HHE, NP22N055IHE

SWITCHING

N-CHANNEL POWER MOS FET

INDUSTRIAL USE

DESCRIPTION

These products are N-channel MOS Field Effect Transistors designed for high current switching applications.

FEATURES

- Channel temperature 175 degree rated
- Super low on-state resistance
 $R_{DS(on)1} = 39 \text{ m}\Omega \text{ MAX. (} V_{GS} = 10 \text{ V, } I_D = 11 \text{ A)}$
- Low C_{iss} : $C_{iss} = 590 \text{ pF TYP.}$
- Built-in gate protection diode

ABSOLUTE MAXIMUM RATINGS ($T_A = 25^\circ\text{C}$)

Drain to Source Voltage	V_{DSS}	55	V
Gate to Source Voltage	V_{GSS}	± 20	V
Drain Current (DC)	$I_{D(DC)}$	± 22	A
Drain Current (Pulse) ^{Note1}	$I_{D(pulse)}$	± 55	A
Total Power Dissipation ($T_A = 25^\circ\text{C}$)	P_T	1.2	W
Total Power Dissipation ($T_c = 25^\circ\text{C}$)	P_T	45	W
Single Avalanche Current ^{Note2}	I_{AS}	13 / 5	A
Single Avalanche Energy ^{Note2}	E_{AS}	16 / 25	mJ
Channel Temperature	T_{ch}	175	$^\circ\text{C}$
Storage Temperature	T_{stg}	-55 to +175	$^\circ\text{C}$

Notes 1. $PW \leq 10 \mu\text{s}$, Duty cycle $\leq 1 \%$

2. Starting $T_{ch} = 25^\circ\text{C}$, $R_G = 25 \Omega$, $V_{GS} = 20 \text{ V} \rightarrow 0 \text{ V}$ (See Figure 4.)

THERMAL RESISTANCE

Channel to Case	$R_{th(ch-C)}$	3.33	$^\circ\text{C/W}$
Channel to Ambient	$R_{th(ch-A)}$	125	$^\circ\text{C/W}$

ORDERING INFORMATION

PART NUMBER	PACKAGE
NP22N055HHE	TO-251
NP22N055IHE	TO-252

(TO-251)

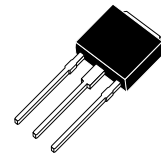

(TO-252)

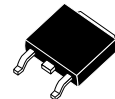

The information in this document is subject to change without notice. Before using this document, please confirm that this is the latest version.
 Not all devices/types available in every country. Please check with local NEC representative for availability and additional information.

查询"NP22N055IHE"供应商
ELECTRICAL CHARACTERISTICS (T_A = 25 °C)

CHARACTERISTICS	SYMBOL	TEST CONDITIONS	MIN.	TYP.	MAX.	UNIT
Drain to Source On-state Resistance	R _{DS(on)}	V _{GS} = 10 V, I _D = 11 A		30	39	mΩ
Gate to Source Threshold Voltage	V _{GS(th)}	V _{DS} = V _{GS} , I _D = 250 μA	2.0	3.0	4.0	V
Forward Transfer Admittance	y _{fs}	V _{DS} = 10 V, I _D = 11 A	4	8		S
Drain Leakage Current	I _{DSS}	V _{DS} = 55 V, V _{GS} = 0 V			10	μA
Gate to Source Leakage Current	I _{GSS}	V _{GS} = ±20 V, V _{DS} = 0 V			±10	μA
Input Capacitance	C _{iss}	V _{DS} = 25 V, V _{GS} = 0 V, f = 1 MHz		590	890	pF
Output Capacitance	C _{oss}			110	170	pF
Reverse Transfer Capacitance	C _{rss}			52	94	pF
Turn-on Delay Time	t _{d(on)}	I _D = 11 A, V _{GS(on)} = 10 V, V _{DD} = 28 V, R _G = 1 Ω		11	24	ns
Rise Time	t _r			6.0	15	ns
Turn-off Delay Time	t _{d(off)}			25	49	ns
Fall Time	t _f			6.6	17	ns
Total Gate Charge	Q _G	I _D = 22 A, V _{DD} = 44 V, V _{GS} = 10 V		12	18	nC
Gate to Source Charge	Q _{GS}			3		nC
Gate to Drain Charge	Q _{GD}			5		nC
Body Diode Forward Voltage	V _{F(S-D)}	I _F = 22 A, V _{GS} = 0 V		1.0		V
Reverse Recovery Time	t _{rr}	I _F = 22 A, V _{GS} = 0 V, di/dt = 100A/μs		35		ns
Reverse Recovery Charge	Q _{rr}			42		nC

TEST CIRCUIT 1 AVALANCHE CAPABILITY

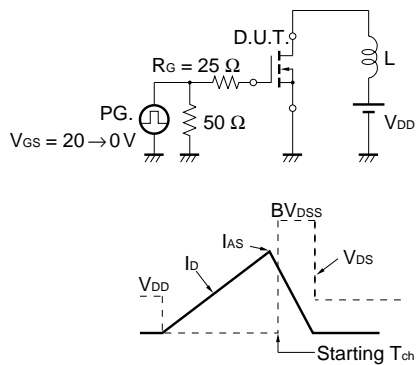

TEST CIRCUIT 2 SWITCHING TIME

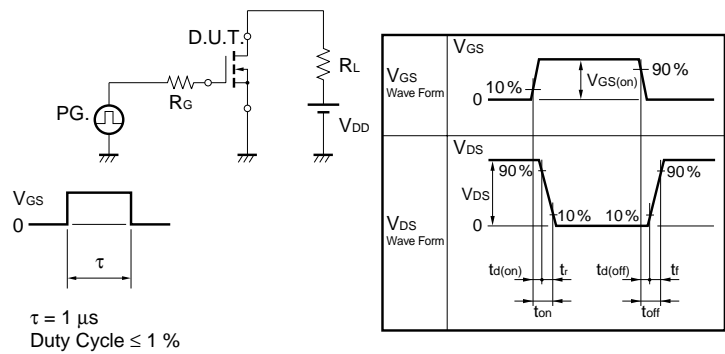

TEST CIRCUIT 3 GATE CHARGE

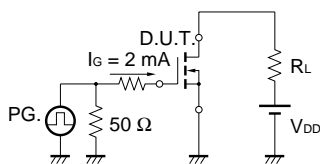

TYPICAL CHARACTERISTICS (T_A = 25 °C)

Figure1. DERATING FACTOR OF FORWARD BIAS SAFE OPERATING AREA

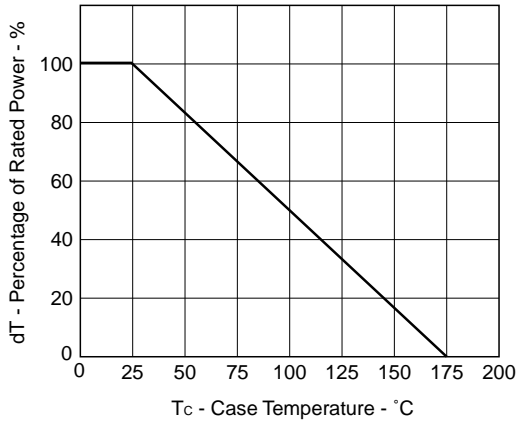
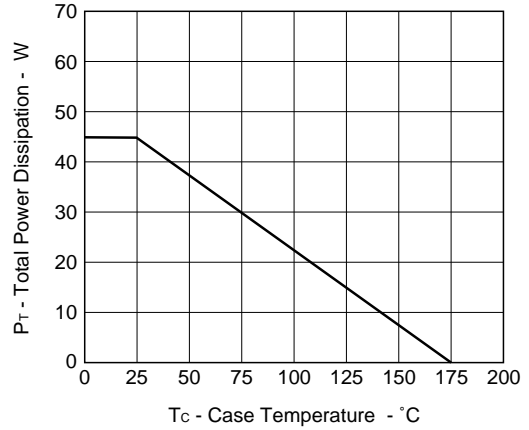

Figure2. TOTAL POWER DISSIPATION vs. CASE TEMPERATURE



★ Figure3. FORWARD BIAS SAFE OPERATING AREA

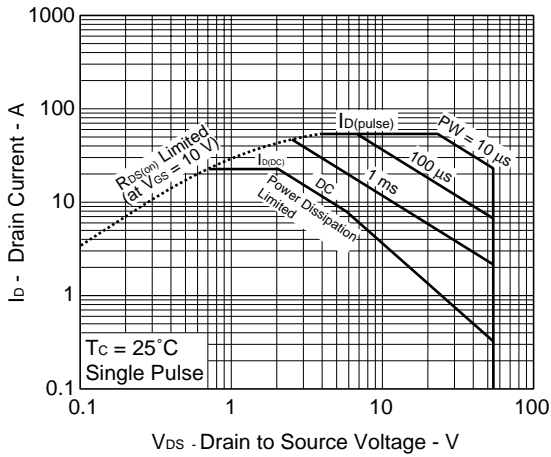

Figure4. SINGLE AVALANCHE ENERGY DERATING FACTOR

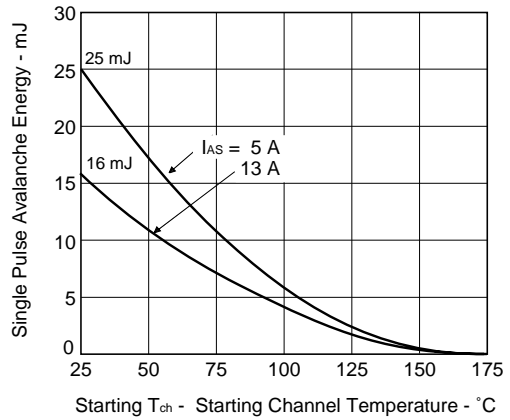
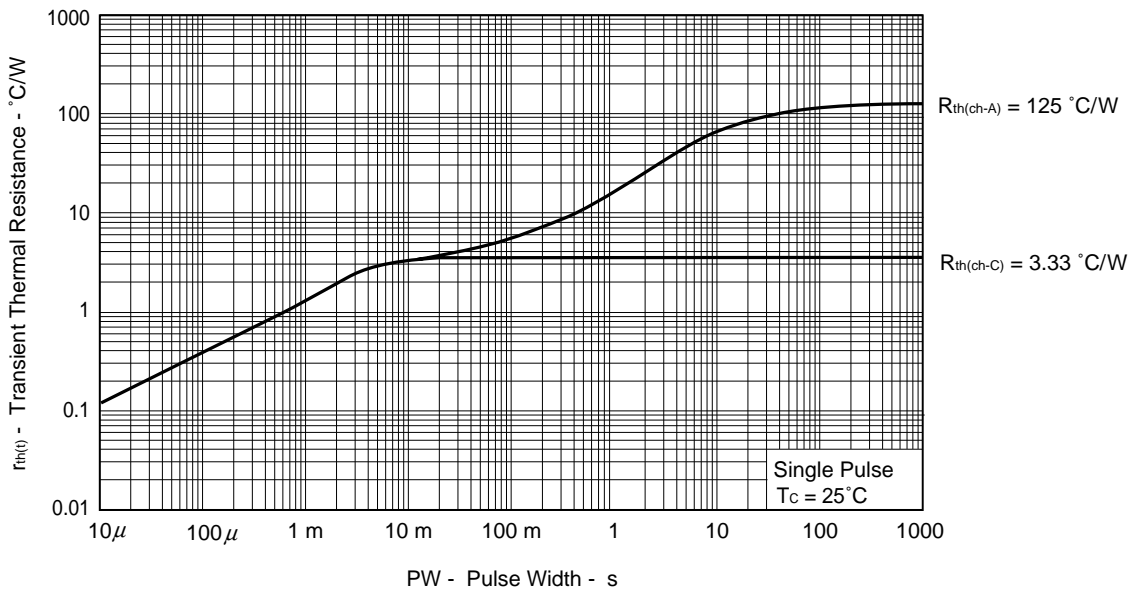

Figure5. TRANSIENT THERMAL RESISTANCE vs. PULSE WIDTH



[查询"NP22N055IHE"供应商](#)

Figure6. FORWARD TRANSFER CHARACTERISTICS

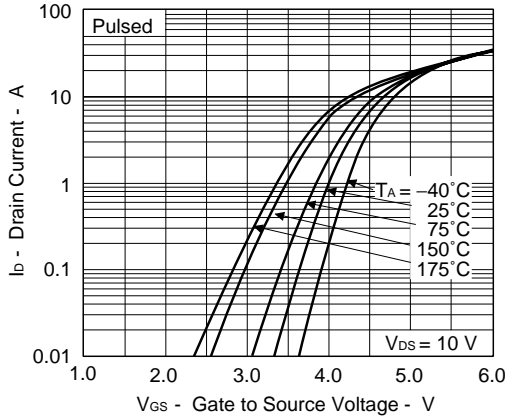

Figure7. DRAIN CURRENT vs. DRAIN TO SOURCE VOLTAGE

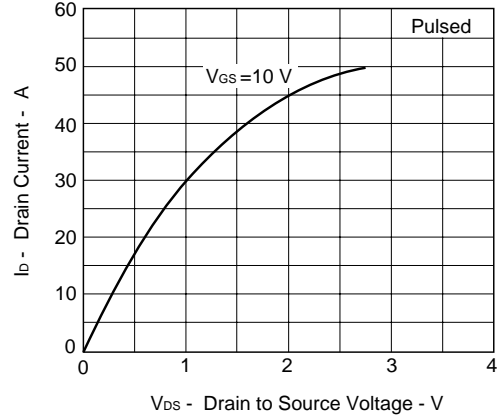

Figure8. FORWARD TRANSFER ADMITTANCE vs. DRAIN CURRENT

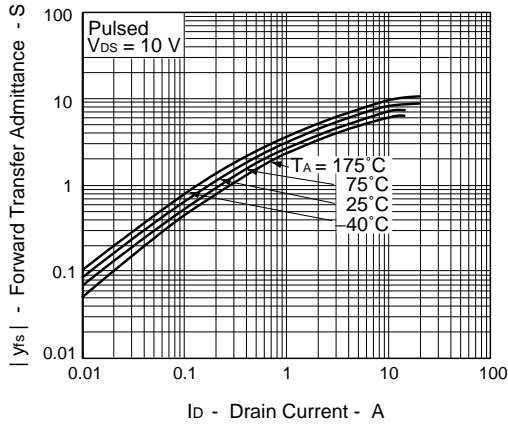

Figure9. DRAIN TO SOURCE ON-STATE RESISTANCE vs. GATE TO SOURCE VOLTAGE

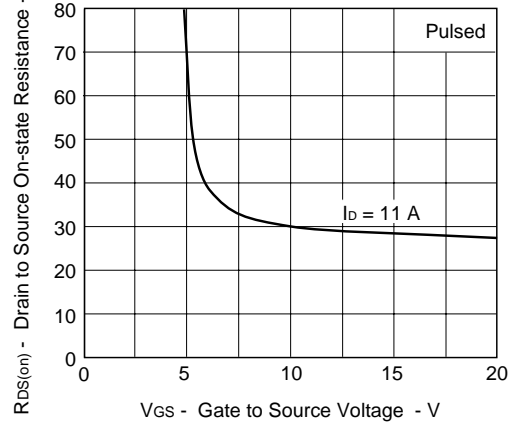

Figure10. DRAIN TO SOURCE ON-STATE RESISTANCE vs. DRAIN CURRENT

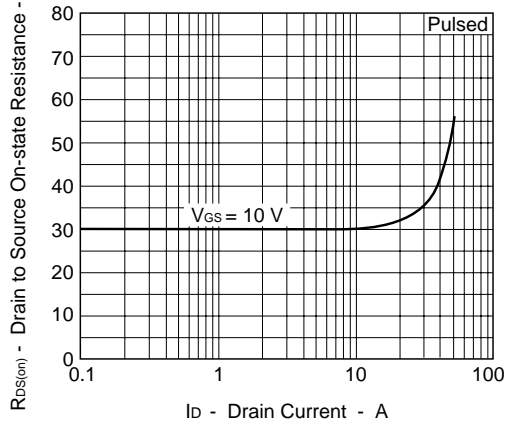
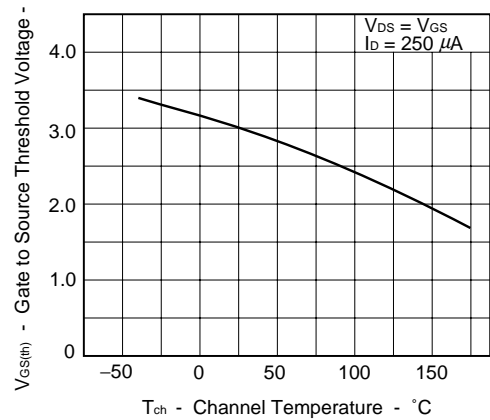

Figure11. GATE TO SOURCE THRESHOLD VOLTAGE vs. CHANNEL TEMPERATURE



查询"NP22N055IHE"供应商

Figure12. DRAIN TO SOURCE ON-STATE RESISTANCE vs. CHANNEL TEMPERATURE

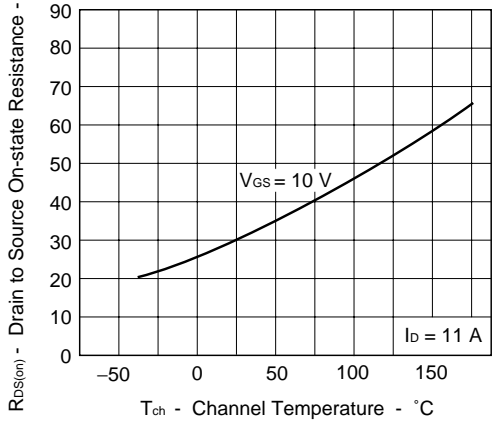

Figure13. SOURCE TO DRAIN DIODE FORWARD VOLTAGE

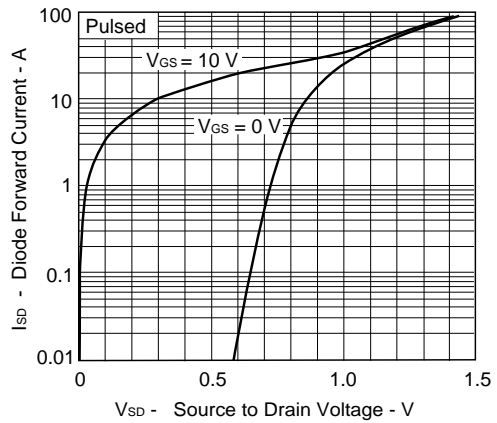

Figure14. CAPACITANCE vs. DRAIN TO SOURCE VOLTAGE

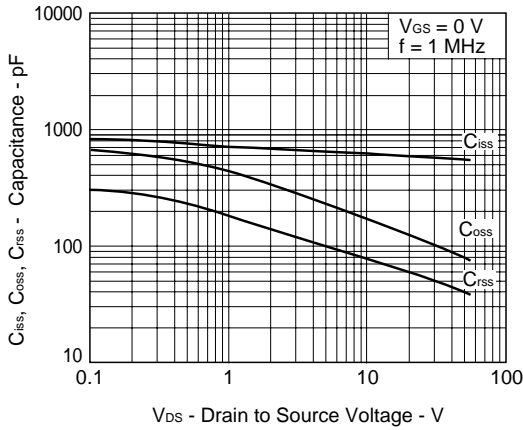

Figure15. SWITCHING CHARACTERISTICS

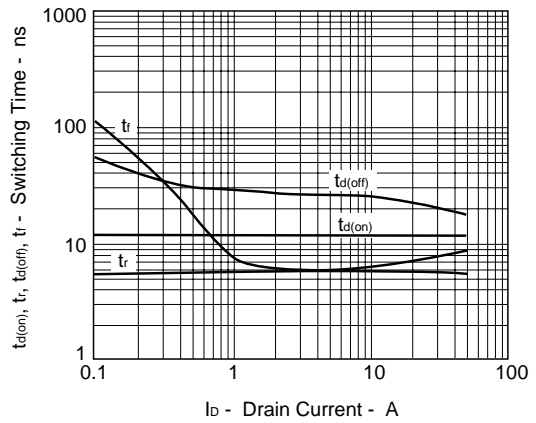

Figure16. REVERSE RECOVERY TIME vs. DRAIN CURRENT

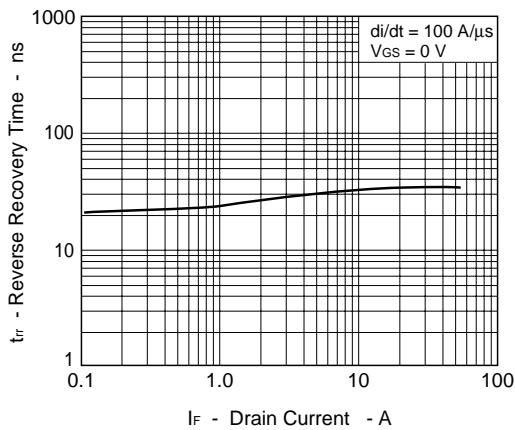
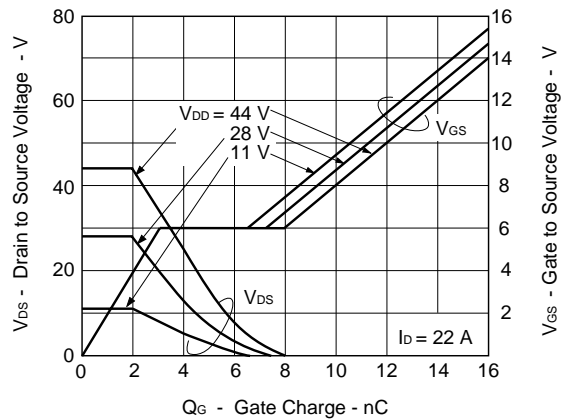
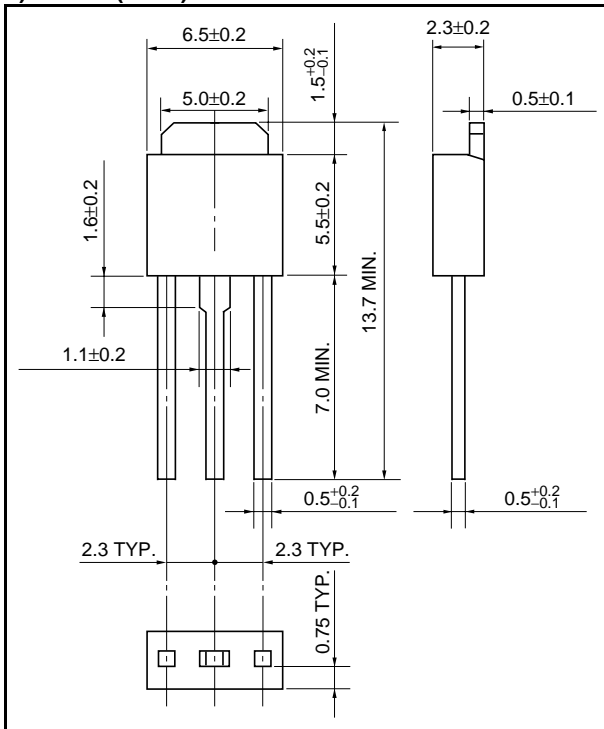

Figure17. DYNAMIC INPUT/OUTPUT CHARACTERISTICS



查询"NP22N055IHE"供应商
PACKAGE DRAWINGS (Unit: mm)

1) TO-251 (MP-3)



2) TO-252 (MP-3Z)

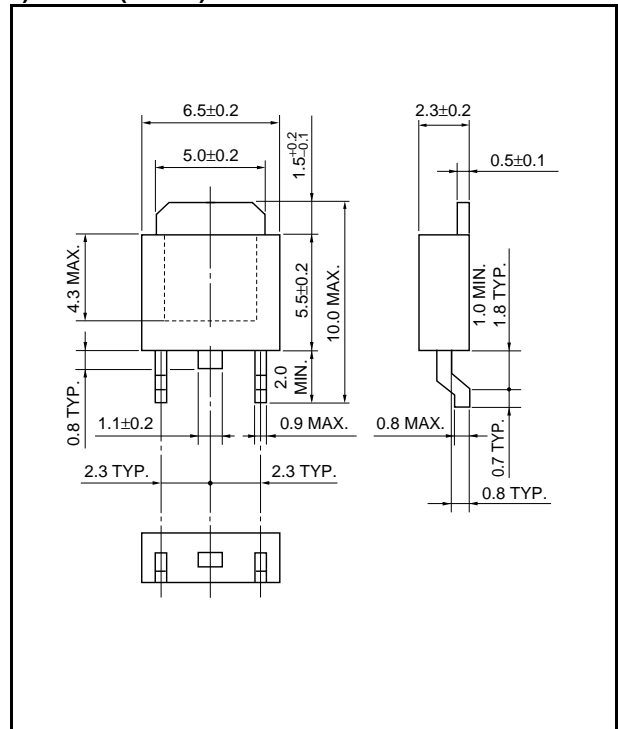

EQUIVALENT CIRCUIT

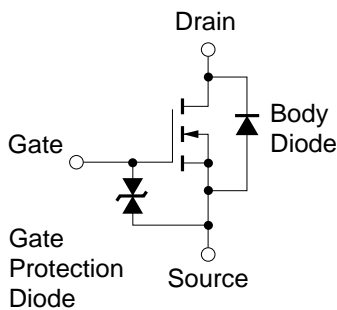

- Remark 1.** These products are an electrostatic sensitive device. Please handle with caution.
- 2.** The diode connected between the gate and source of the transistor serves as a protector against ESD. When this device actually used, an additional protection circuit is externally required if a voltage exceeding the rated voltage may be applied to this device.

[MEMO](#) [查询"NP22N055IHE"供应商](#)

[查询"NP22N055IHE"供应商](#)

- **The information in this document is current as of March, 2001. The information is subject to change without notice. For actual design-in, refer to the latest publications of NEC's data sheets or data books, etc., for the most up-to-date specifications of NEC semiconductor products. Not all products and/or types are available in every country. Please check with an NEC sales representative for availability and additional information.**
 - No part of this document may be copied or reproduced in any form or by any means without prior written consent of NEC. NEC assumes no responsibility for any errors that may appear in this document.
 - NEC does not assume any liability for infringement of patents, copyrights or other intellectual property rights of third parties by or arising from the use of NEC semiconductor products listed in this document or any other liability arising from the use of such products. No license, express, implied or otherwise, is granted under any patents, copyrights or other intellectual property rights of NEC or others.
 - Descriptions of circuits, software and other related information in this document are provided for illustrative purposes in semiconductor product operation and application examples. The incorporation of these circuits, software and information in the design of customer's equipment shall be done under the full responsibility of customer. NEC assumes no responsibility for any losses incurred by customers or third parties arising from the use of these circuits, software and information.
 - While NEC endeavours to enhance the quality, reliability and safety of NEC semiconductor products, customers agree and acknowledge that the possibility of defects thereof cannot be eliminated entirely. To minimize risks of damage to property or injury (including death) to persons arising from defects in NEC semiconductor products, customers must incorporate sufficient safety measures in their design, such as redundancy, fire-containment, and anti-failure features.
 - NEC semiconductor products are classified into the following three quality grades:
 "Standard", "Special" and "Specific". The "Specific" quality grade applies only to semiconductor products developed based on a customer-designated "quality assurance program" for a specific application. The recommended applications of a semiconductor product depend on its quality grade, as indicated below. Customers must check the quality grade of each semiconductor product before using it in a particular application.
 - "Standard": Computers, office equipment, communications equipment, test and measurement equipment, audio and visual equipment, home electronic appliances, machine tools, personal electronic equipment and industrial robots
 - "Special": Transportation equipment (automobiles, trains, ships, etc.), traffic control systems, anti-disaster systems, anti-crime systems, safety equipment and medical equipment (not specifically designed for life support)
 - "Specific": Aircraft, aerospace equipment, submersible repeaters, nuclear reactor control systems, life support systems and medical equipment for life support, etc.
- The quality grade of NEC semiconductor products is "Standard" unless otherwise expressly specified in NEC's data sheets or data books, etc. If customers wish to use NEC semiconductor products in applications not intended by NEC, they must contact an NEC sales representative in advance to determine NEC's willingness to support a given application.
- (Note)
- (1) "NEC" as used in this statement means NEC Corporation and also includes its majority-owned subsidiaries.
 - (2) "NEC semiconductor products" means any semiconductor product developed or manufactured by or for NEC (as defined above).