

SL74HC4046

[查询"MM74HC4046N"供应商](#)

Phase-Locked Loop High-Performance Silicon-Gate CMOS

The device inputs are compatible with standard CMOS outputs; with pullup resistors, they are compatible with LS/ALSTTL outputs.

The SL74HC4046 phase-locked loop contains three phase comparators, a voltage-controlled oscillator (VCO) and unity gain op-amp DEM_{OUT}. The comparators have two common signal inputs, COMP_{IN}, and SIG_{IN}. Input SIG_{IN} and COMP_{IN} can be used directly coupled to large voltage signals, or indirectly coupled (with a series capacitor to small voltage signals). The self-bias circuit adjusts small voltage signals in the linear region of the amplifier. Phase comparator 1 (an exclusive OR gate) provides a digital error signal PC1_{OUT} and maintains 90 degrees phase shift at the center frequency between SIG_{IN} and COMP_{IN} signals (both at 50% duty cycle). Phase comparator 2 (with leading-edge sensing logic) provides digital error signals PC2_{OUT} and PCP_{OUT} and maintains a 0 degree phase shift between SIG_{IN} and COMP_{IN} signals (duty cycle is immaterial). The linear VCO produces an output signal VCO_{OUT} whose frequency is determined by the voltage of input VCO_{IN} signal and the capacitor and resistors connected to pins C1A, C1B, R1 and R2. The unity gain op-amp output DEM_{OUT} with an external resistor is used where the VCO_{IN} signal is needed but no loading can be tolerated. The inhibit input, when high, disables the VCO and all on-amps to minimize standby power consumption.

Applications include FM and FSK modulation and demodulation, frequency synthesis and multiplication, frequency discrimination, tone decoding, data synchronization and conditioning, voltage-to-frequency conversion and motor speed control.

- Low Power Consumption Characteristic of CMOS Device
- Operating Speeds Similary to LS/ALSTTL
- Wide Operating Voltage Range: 3.0 to 6.0 V
- Low Input Current: 1.0 μ A Maximum (except SIG_{IN} and COMP_{IN})
- Low Quiescent Current: 80 μ A Maximum (VCO disabled)
- High Noise Immunity Characteristic of CMOS Devices
- Diode Protection on all Inputs

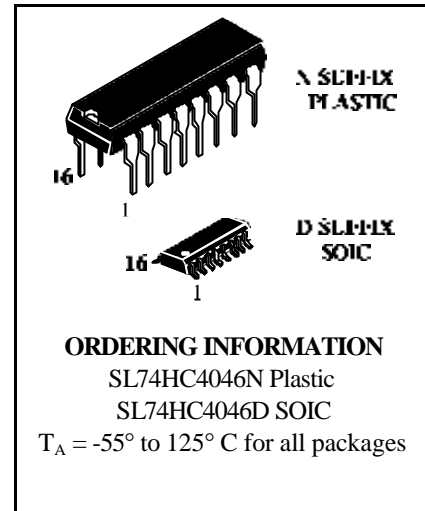

PIN ASSIGNMENT

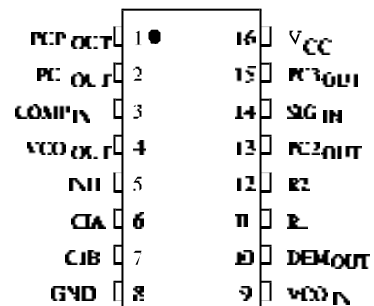

Pin No.	Symbol	Name and Function
1	PCP _{OUT}	Phase Comparator Pulse Output
2	PC1 _{OUT}	Phase Comparator 1 Output
3	COMP _{IN}	Comparator Input
4	VCO _{OUT}	VCO Output
5	INH	Inhibit Input
6	C1A	Capacitor C1 Connection A
7	C1B	Capacitor C1 Connection B
8	GND	Ground (0 V) V _{SS}
9	VCO _{IN}	VCO Input
10	DEM _{OUT}	Demodulator Output
11	R1	Resistor R1 Connection
12	R2	Resistor R2 Connection
13	PC2 _{OUT}	Phase Comparator 2 Output
14	SIG _{IN}	Signal Input
15	PC3 _{OUT}	Phase Comparator 3 Output
16	V _{CC}	Positive Supply Voltage



MAXIMUM RATINGS*

Symbol	Parameter	Value	Unit
V _{CC}	DC Supply Voltage (Referenced to GND)	-0.5 to +7.0	V
V _{IN}	DC Input Voltage (Referenced to GND)	-1.5 to V _{CC} +1.5	V
V _{OUT}	DC Output Voltage (Referenced to GND)	-0.5 to V _{CC} +0.5	V
I _{IN}	DC Input Current, per Pin	±20	mA
I _{OUT}	DC Output Current, per Pin	±25	mA
I _{CC}	DC Supply Current, V _{CC} and GND Pins	±50	mA
P _D	Power Dissipation in Still Air, Plastic DIP+ SOIC Package+	750 500	mW
T _{stg}	Storage Temperature	-65 to +150	°C
T _L	Lead Temperature, 1 mm from Case for 10 Seconds (Plastic DIP or SOIC Package)	260	°C

*Maximum Ratings are those values beyond which damage to the device may occur. Functional operation should be restricted to the Recommended Operating Conditions.
 +Derating - Plastic DIP: - 10 mW/°C from 65° to 125°C
 SOIC Package: - 7 mW/°C from 65° to 125°C

RECOMMENDED OPERATING CONDITIONS

Symbol	Parameter	Min	Max	Unit
V _{CC}	DC Supply Voltage (Referenced to GND) VCO only	3.0	6.0	V
V _{CC}	DC Supply Voltage (Referenced to GND) NON-VCO	2.0	6.0	V
V _{IN} , V _{OUT}	DC Input Voltage, Output Voltage (Referenced to GND)	0	V _{CC}	V
T _A	Operating Temperature, All Package Types	-55	+125	°C
t _r , t _f	Input Rise and Fall Time (Figure 1)			
	V _{CC} =2.0 V	0	1000	ns
	V _{CC} =4.5 V	0	500	
	V _{CC} =6.0 V	0	400	

This device contains protection circuitry to guard against damage due to high static voltages or electric fields. However, precautions must be taken to avoid applications of any voltage higher than maximum rated voltages to this high-impedance circuit. For proper operation, V_{IN} and V_{OUT} should be constrained to the range GND ≤ (V_{IN} or V_{OUT}) ≤ V_{CC}.

Unused inputs must always be tied to an appropriate logic voltage level (e.g., either GND or V_{CC}). Unused outputs must be left open.

SL74HC4046

[查询"MM74HC4046N"供应商](#)

[Phase Comparator Section]

DC ELECTRICAL CHARACTERISTICS (Voltages Referenced to GND)

Symbol	Parameter	Test Conditions	V _{CC} V	Guaranteed Limit			Unit
				25 °C to -55°C	≤85 °C	≤125 °C	
V _{IH}	Minimum High-Level Input Voltage DC Coupled SIG _{IN} , COMP _{IN}	V _{OUT} = 0.1 V or V _{CC} -0.1 V I _{OUT} ≤ 20 μA	2.0	1.5	1.5	1.5	V
			4.5	3.15	3.15	3.15	
			6.0	4.2	4.2	4.2	
V _{IL}	Maximum Low-Level Input Voltage DC Coupled SIG _{IN} , COMP _{IN}	V _{OUT} =0.1 V or V _{CC} -0.1 V I _{OUT} ≤ 20 μA	2.0	0.5	0.5	0.5	V
			4.5	1.35	1.35	1.35	
			6.0	1.8	1.8	1.8	
V _{OH}	Minimum High-Level Output Voltage PCP _{OUT} , PCn _{OUT}	V _{IN} =V _{IH} or V _{IL} I _{OUT} ≤ 20 μA	2.0	1.9	1.9	1.9	V
			4.5	4.4	4.4	4.4	
		6.0	5.9	5.9	5.9		
		V _{IN} = V _{IH} or V _{IL} I _{OUT} ≤ 4.0 mA I _{OUT} ≤ 5.2 mA	4.5	3.98	3.84	3.7	
6.0	5.48		5.34	5.2			
V _{OL}	Maximum Low-Level Output Voltage Q _a -Q _h PCP _{OUT} , PCn _{OUT}	V _{IN} =V _{IH} or V _{IL} I _{OUT} ≤ 20 μA	2.0	0.1	0.1	0.1	V
			4.5	0.1	0.1	0.1	
		6.0	0.1	0.1	0.1		
		V _{IN} = V _{IH} or V _{IL} I _{OUT} ≤ 4.0 mA I _{OUT} ≤ 5.2 mA	4.5	0.26	0.33	0.4	
6.0	0.26		0.33	0.4			
I _{IN}	Maximum Input Leakage Current SIG _{IN} , COMP _{IN}	V _{IN} =V _{CC} or GND	2.0	±3.0	±4.0	±5.0	μA
			3.0	±7.0	±9.0	±11.0	
			4.5	±18.0	±23.0	±27.0	
			6.0	±30.0	±38.0	±45.0	
I _{OZ}	Maximum Three-State Leakage Current PC2 _{OUT}	Output in High-Impedance State V _{IN} = V _{IL} or V _{IH} V _{OUT} =V _{CC} or GND	6.0	±0.5	±5.0	±10	μA
I _{CC}	Maximum Quiescent Supply Current (per Package) (VCO disabled) Pins 3,5 and 14 at V _{CC} Pin 9 at GND; Input Leakage at Pin 3 and 14 to be excluded	V _{IN} =V _{CC} or GND I _{OUT} =0μA	6.0	4.0	40	160	μA



[Phase Comparator Section]**AC ELECTRICAL CHARACTERISTICS**($C_L=50\text{pF}$, Input $t_r=t_f=6.0\text{ ns}$)

Symbol	Parameter	V_{CC} V	Guaranteed Limit			Unit
			25 °C to -55°C	≤85°C	≤125°C	
t_{PLH}, t_{PHL}	Maximum Propagation Delay, $SIG_{IN}/COMP_{IN}$ to $PC1_{OUT}$ (Figure 1)	2.0	175	220	265	ns
		4.5	35	44	53	
		6.0	30	37	45	
t_{PLH}, t_{PHL}	Maximum Propagation Delay, $SIG_{IN}/COMP_{IN}$ to PCP_{OUT} (Figure 1)	2.0	340	425	510	ns
		4.5	68	85	102	
		6.0	58	72	87	
t_{PLH}, t_{PHL}	Maximum Propagation Delay, $SIG_{IN}/COMP_{IN}$ to $PC3_{OUT}$ (Figure 1)	2.0	270	340	405	ns
		4.5	54	68	81	
		6.0	46	58	69	
t_{PLZ}, t_{PHZ}	Maximum Propagation Delay, $SIG_{IN}/COMP_{IN}$ Output Disable Time to $PC2_{OUT}$ (Figures 2 and 3)	2.0	200	250	300	ns
		4.5	40	50	60	
		6.0	34	43	51	
t_{PZL}, t_{PZH}	Maximum Propagation Delay, $SIG_{IN}/COMP_{IN}$ Output Enable Time to $PC2_{OUT}$ (Figures 2 and 3)	2.0	230	290	345	ns
		4.5	46	58	69	
		6.0	39	49	59	
t_{TLH}, t_{THL}	Maximum Output Transition Time (Figure 1)	2.0	75	95	110	ns
		4.5	15	19	22	
		6.0	13	16	19	

[VCO Section]**DC ELECTRICAL CHARACTERISTICS**(Voltages Referenced to GND)

Symbol	Parameter	Test Conditions	V_{CC} V	Guaranteed Limit			Unit
				25 °C to-55°C	≤85°C	≤125°C	
V_{IH}	Minimum High-Level Input Voltage INH	$V_{OUT}=0.1\text{ V}$ or $V_{CC}-0.1\text{ V}$ $ I_{OUT} \leq 20\ \mu\text{A}$	3.0	2.1	2.1	2.1	V
			4.5	3.15	3.15	3.15	
			6.0	4.2	4.2	4.2	
V_{IL}	Maximum Low-Level Input Voltage INH	$V_{OUT}=0.1\text{ V}$ or $V_{CC}-0.1\text{ V}$ $ I_{OUT} \leq 20\ \mu\text{A}$	3.0	0.90	0.90	0.90	V
			4.5	1.35	1.35	1.35	
			6.0	1.8	1.8	1.8	
V_{OH}	Minimum High-Level Output Voltage VCO_{OUT}	$V_{IN}=V_{IH}$ or V_{IL} $ I_{OUT} \leq 20\ \mu\text{A}$	3.0	1.9	1.9	1.9	V
			4.5	4.4	4.4	4.4	
		6.0	5.9	5.9	5.9		
		$V_{IN}=V_{IH}$ or V_{IL} $ I_{OUT} \leq 4.0\text{ mA}$ $ I_{OUT} \leq 5.2\text{ mA}$	4.5	3.98	3.84	3.7	
6.0	5.48		5.34	5.2			
V_{OL}	Maximum Low-Level Output Voltage VCO_{OUT}	$V_{IN}=V_{IH}$ or V_{IL} $ I_{OUT} \leq 20\ \mu\text{A}$	3.0	0.1	0.1	0.1	V
			4.5	0.1	0.1	0.1	
			6.0	0.1	0.1	0.1	
		$V_{IN}=V_{IH}$ or V_{IL} $ I_{OUT} \leq 4.0\text{ mA}$ $ I_{OUT} \leq 5.2\text{ mA}$	4.5	0.26	0.33	0.4	
6.0	0.26		0.33	0.4			

SL74HC4046

[查询"MM74HC4046N"供应商](#)

(continued)

[VCO Section]

DC ELECTRICAL CHARACTERISTICS(Voltages Referenced to GND) - continued

Symbol	Parameter	Test Conditions	V _{CC} V	Guaranteed Limit						Unit
				25 °C to -55°C		≤85°C		≤125°C		
I _{IN}	Maximum Input Leakage Current INH, VCO _{IN}	V _{IN} = V _{CC} or GND	6.0	0.1		1.0		1.0		μA
V _{VCOIN}	Operating Voltage Range at VCO _{IN} over the range specified for R1; For linearity see Fig.13A, Parallel value of R1 and R2 should be >2.7 kΩ	INH= V _{IL}	3.0	Min	Max	Min	Max	Min	Max	V
			4.5	0.1	1.0	0.1	1.0	0.1	1.0	
			6.0	0.1	2.5	0.1	2.5	0.1	2.5	
R1	Resistor Range		3.0	3.0	300	3.0	300	3.0	300	kΩ
			4.5	3.0	300	3.0	300	3.0	300	
			6.0	3.0	300	3.0	300	3.0	300	
R2	Resistor Range		3.0	3.0	300	3.0	300	3.0	300	kΩ
			4.5	3.0	300	3.0	300	3.0	300	
			6.0	3.0	300	3.0	300	3.0	300	
C1	Capacitor Range		3.0	40	No					pF
			4.5	40	Li-					
			6.0	40	mit					

[VCO Section]

AC ELECTRICAL CHARACTERISTICS(C_L=50pF,Input t_r=t_f=6.0 ns)

Symbol	Parameter	V _{CC} V	Guaranteed Limit						Unit
			25 °C to -55°C		≤85°C		≤125°C		
			Min	Max	Min	Max	Min	Max	
Δf/T	Frequency Stability with Temperature Changes (Figures 11A,B,C)	3.0							% /K
		4.5							
		6.0							
f _o	VCO Center Frequency (Duty Factor = 50%) (Figures 12A,B,C)	3.0	3					MHz	
		4.5	11						
		6.0	13						
ΔfVCO	VCO Frequency Linearity	3.0	See Figures 13A,B						%
		4.5							
		6.0							
∂VCO	Duty Factor at VCO _{OUT}	3.0	Typical 50%						%
		4.5							
		6.0							

SL74HC4046

[查询"MM74HC4046N"供应商](#)

[Demodulator Section]

DC ELECTRICAL CHARACTERISTICS

Symbol	Parameter	Test Conditions	V _{CC} V	Guaranteed Limit						Unit
				25 °C to -55°C		≤85°C		≤125°C		
				Min	Max	Min	Max	Min	Max	
RS	Resistor Range	At RS > 300 kΩ the Leakage Current can Influence VDEM _{OUT}	3.0 4.5 6.0	50 50 50	300 300 300					kΩ
V _{OFF}	Offset Voltage VCO _{IN} to VDEM _{OUT}	V _I = VVCO _{IN} = 1/2 V _{CC} ; Values taken over RS Range	3.0 4.5 6.0	See Figure 10						mV
RD	Dynamic Output Resistance at DEM _{OUT}	VDEM _{OUT} = 1/2 V _{CC}	3.0 4.5 6.0	Typical 25 Ω						Ω

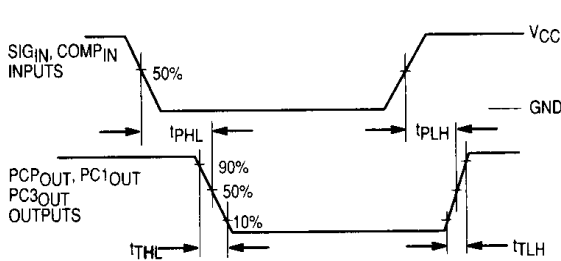

Figure 1. Switching Waveforms

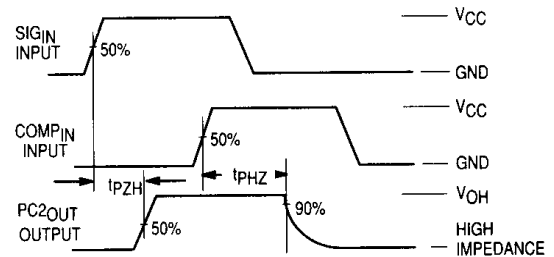

Figure 2. Switching Waveforms

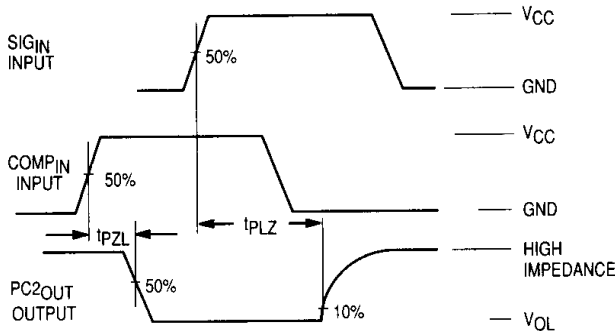
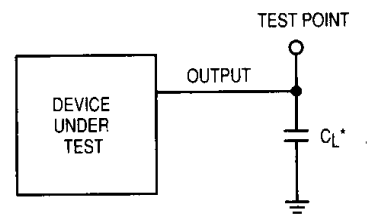

Figure 3. Switching Waveforms



*INCLUDES ALL PROBE AND JIG CAPACITANCE

Figure 4. Test Circuit

DETAILED CIRCUIT DESCRIPTION

Voltage Controlled Oscillator/Demodulator Output

The VCO requires two or three external components to operate. These are R1, R2, C1. Resistor R1 and Capacitor C1 are selected to determine the center frequency of the VCO (see typical performance curves Figure 12). R2 can be used to set the offset frequency with 0 volts at VCO input. For example, if R2 is decreased, the offset frequency is increased. If R2 is omitted the VCO range is from 0 Hz. By increasing the value of R2 the lock range of the PLL is increased and the gain (volts/Hz) is decreased. Thus, for a narrow lock range, large swings on the VCO input will cause less frequency variation.

Internally, the resistors set a current in a current mirror, as shown in Figure 5. The mirrored current drives one side of the capacitor. Once the voltage across the capacitor charges up to V_{ref} of the comparators, the oscillator logic flips the capacitor which causes the mirror to change the opposite side of

the capacitor. The output from the internal logic is then taken to VCO output (Pin4).

The input to the VCO is a very high impedance CMOS input and thus will not load down the loop filter, easing the filters design. In order to make signals at the VCO input accessible without degrading the loop performance, the VCO input voltage is buffered through a unity gain Op-amp, to Demod Output. This Op-amp can drive loads of 50K ohms or more and provides no loading effects to the VCO input voltage (see Figure 10).

An inhibit input is provided to allow disabling of the VCO and all Op-amps (see Figure 5). This is useful if the internal VCO is not being used. A logic high on inhibit disables the VCO and all Op-amps, minimizing standby power consumption.

The output of the VCO is a standard high speed CMOS output with an equivalent LS-TTL fan out of 10. The VCO output is approximately a square wave. This output can either directly feed the $COMP_{IN}$ of the phase comparators or feed external prescalers (counters) to enable frequency synthesis.

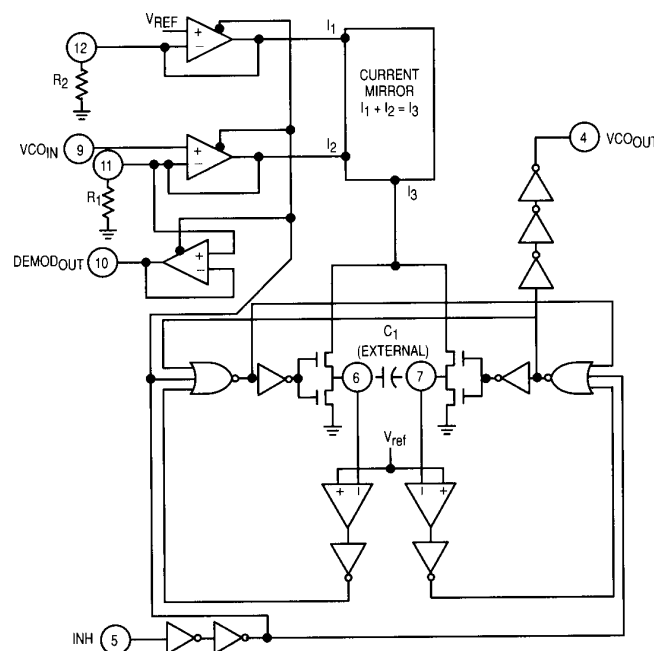

Figure 5. Logic Diagram for VCO

Phase Comparators

All three phase comparators have two inputs, SIG_{IN} and $COMP_{IN}$. The SIG_{IN} and $COMP_{IN}$ have a special DC bias network that enables AC coupling of input signals. If the signals are not AC coupled, standard SL74HC input levels are required. Both input structures are shown in Figure 6. The outputs of these

comparators are essentially standard SL74HC outputs (comparator 2 is TRI-STATEABLE). In normal operation V_{CC} and ground voltage levels are fed to the loop filter. This differs from some phase detectors which supply a current to the loop filter and should be considered in the design.

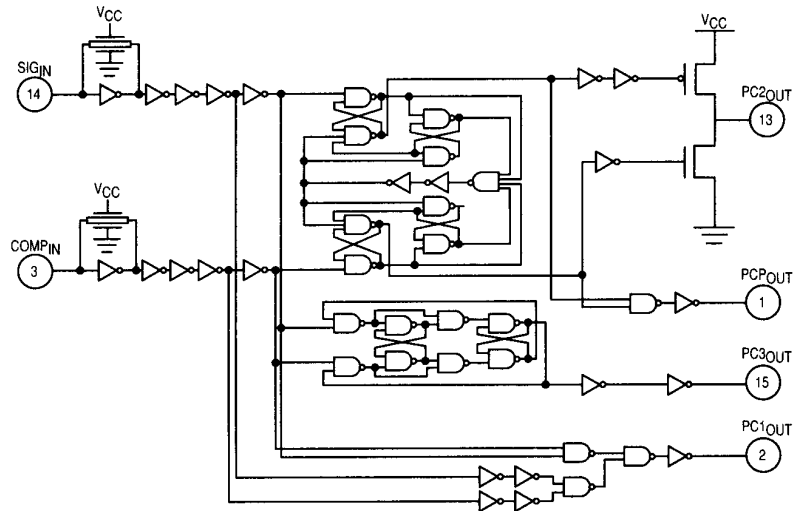

Figure 6. Logic Diagram for Phase Comparators

Phase Comparator 1

This comparator is a simple XOR gate similar to the SL74HC86. Its operation is similar to an overdriven balanced modulator. To maximize lock range the input frequencies must have a 50% duty cycle. Typical input and output waveforms are shown in Figure 7. The output of the phase detector feeds the loop filter which averages the output voltage. The frequency range upon which the PLL will lock onto if initially out of lock is defined as the capture range. The capture range for phase detector 1 is dependent on the loop filter design. The capture range can be as large as the lock range, which is equal to the VCO frequency range.

To see how the detector operates, refer to Figure 7. When two square wave signals are applied to this comparator, an output waveform (whose duty cycle is dependent on the phase difference between the two signals) results. As the phase difference increases, the output duty cycle increases and the voltage after the loop filter increases. In order to achieve lock when the PLL input frequency increases, the VCO input voltage must increase and the phase difference between $COMP_{IN}$ and SIG_{IN} will increase. At an input frequency equal to f_{min} , the VCO input is at 0 V

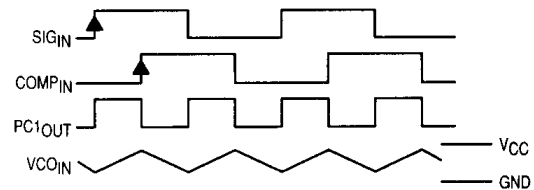

Figure 7. Typical Waveforms for PLL Using Phase Comparator 1

This requires the phase detector output to be grounded; hence, the two input signals must be in phase. When the input frequency is f_{max} , the VCO input must be V_{CC} and the phase detector inputs must be 180 degrees out of phase.

The XOR is more susceptible to locking onto harmonics of the SIG_{IN} than the digital phase detector 2. For instance, a signal 2 times the VCO frequency results in the same output duty cycle as a signal equal to the VCO frequency. The difference is that the output frequency of the 2f example is twice that of the other example. The loop filter and VCO range should be designed to prevent locking on to harmonics.

Phase Comparator 2

This detector is a digital memory network. It consists of four flip-flops and some gating logic, a three state output and a phase pulse output as shown in Figure 6. This comparator acts only on the positive edges of the input signals and is independent of duty cycle.

Phase comparator 2 operates in such a way as to force the PLL into lock with 0 phase difference between the VCO output and the signal input positive waveform edges. Figure 8 shows some typical loop waveforms. First assume that SIG_{IN} is leading the COMP_{IN}. This means that the VCO's frequency must be increased to bring its leading edge into proper phase alignment. Thus the phase detector 2 output is set high. This will cause the loop filter to charge up the VCO input, increasing the VCO frequency. Once the leading edge of the COMP_{IN} is detected, the output goes TRI-STATE holding the VCO input at the loop filter voltage. If the VCO still lags the SIG_{IN} then the phase detector will again charge up the VCO input for the time between the leading edges of both waveforms.

If the VCO leads the SIG_{IN} then when the leading edge of the VCO is seen; the output of the phase comparator goes low. This discharges the loop filter until the leading edge of the SIG_{IN} is detected at which time the output disables itself again. This has the effect of slowing down the VCO to again make the rising edges of both waveforms coincidental.

When the PLL is out of lock, the VCO will be running either slower or faster than the SIG_{IN}. If it is running slower the phase detector will see more SIG_{IN} rising edges and so the output of the phase comparator will be high a majority of the time, raising the VCO's frequency. Conversely, if the VCO is running faster than the SIG_{IN}, the output of the detector will be low most of the time and the VCO's output frequency will be decreased.

As one can see, when the PLL is locked, the output of phase comparator 2 will be disabled except for minor corrections at the leading edge of the waveforms. When PC₂ is TRI-STATED, the PCP output is high. This output can be used to determine when the PLL is in the locked condition.

This detector has several interesting characteristics. Over the entire VCO frequency range there is no phase difference between the COMP_{IN} and the SIG_{IN}. The lock range of the PLL is the same as the capture range. Minimal power was consumed in the loop filter since in lock the detector output is a high impedance. When no SIG_{IN} is present, the detector will

see only VCO leading edges, so the comparator output will stay low, forcing the VCO to f_{min} .

Phase comparator 2 is more susceptible to noise, causing the PLL to unlock. If a noise pulse is seen on the SIG_{IN}, the comparator treats it as another positive edge of the SIG_{IN} and will cause the output to go high until the VCO leading edge is seen, potentially for an entire SIG_{IN} period. This would cause the VCO to speed up during that time. When using PC₁, the output of that phase detector would be disturbed for only the short duration of the noise spike and would cause less upset.

Phase Comparator 3

This is positive edge-triggered sequential phase detector using an RS flip-flop as shown in Figure 6. When the PLL is using this comparator, the loop is controlled by positive signal transitions and the duty factors of SIG_{IN} and COMP_{IN} are not important. It has some similar characteristics to the edge sensitive comparator. To see how this detector works, assume input pulses are applied to the SIG_{IN} and COMP_{IN}'s as shown in Figure 9. When the SIG_{IN} leads the COMP_{IN}, the flop is set. This will charge the loop filter and cause the VCO to speed up, bringing the comparator into phase with the SIG_{IN}. The phase angle between SIG_{IN} and COMP_{IN} varies from 0° to 360° and is 180° at f_0 . The voltage swing for PC₃ is greater than for PC₂ but consequently has more ripple in the signal to the VCO. When no SIG_{IN} is present the VCO will be forced to f_{max} as opposed to f_{min} when PC₂ is used.

The operating characteristics of all three phase comparators should be compared to the requirement of the system design and the appropriate one should be used.

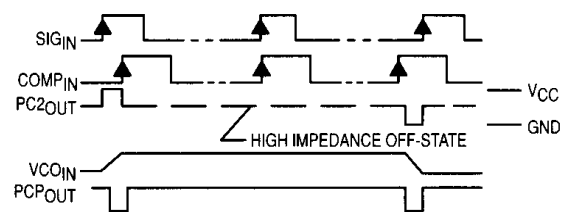

Figure 8. Typical Waveforms for PLL Using Phase Comparator 2

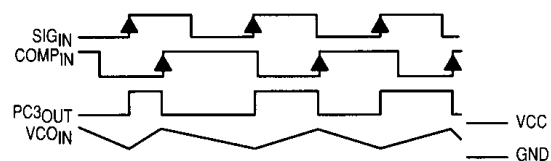

Figure 9. Typical Waveforms for PLL Using Phase Comparator 3

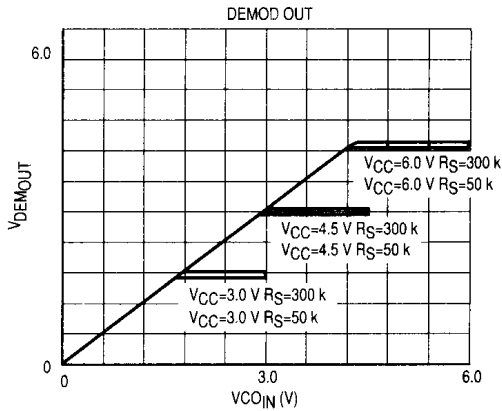

Figure 10. Offset Voltage at Demodulator Output as a Function of V_{COIN} and R_S

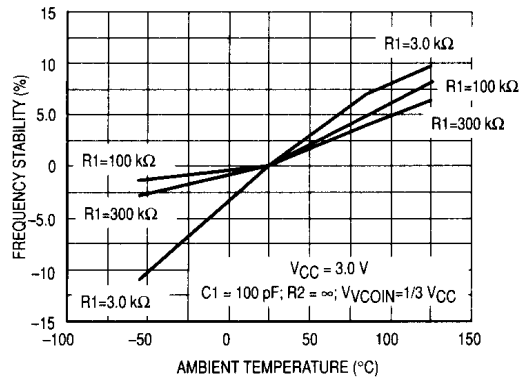

Figure 11A. Frequency Stability versus Ambient Temperature: $V_{CC} = 3.0 V$

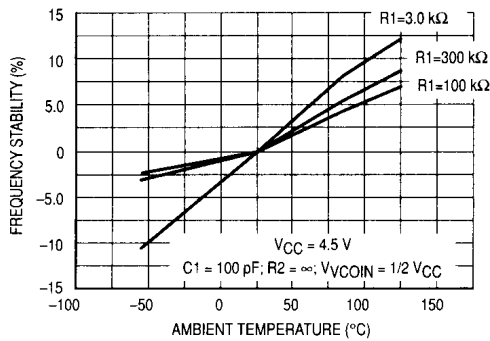

Figure 11B. Frequency Stability versus Ambient Temperature: $V_{CC} = 4.5 V$

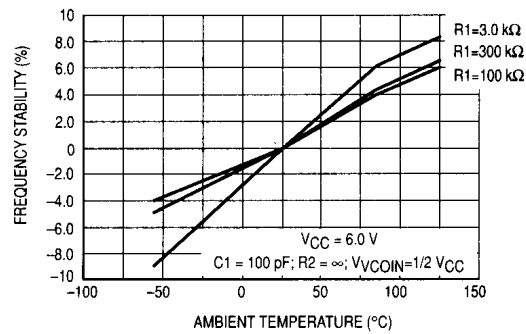

Figure 11C. Frequency Stability versus Ambient Temperature: $V_{CC} = 6.0 V$

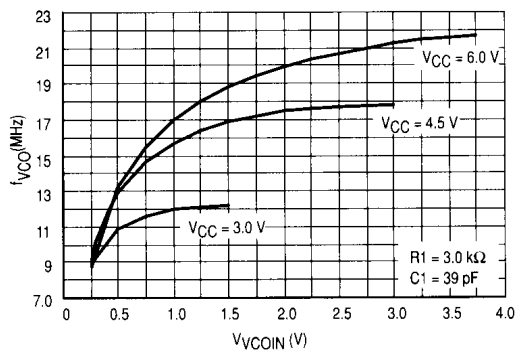

Figure 12A. VCO Frequency (f_{VCO}) as a Function of the VCO Input Voltage (V_{COIN})

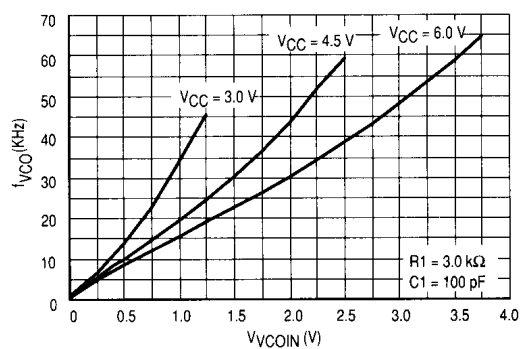

Figure 12B. VCO Frequency (f_{VCO}) as a Function of the VCO Input Voltage (V_{COIN})

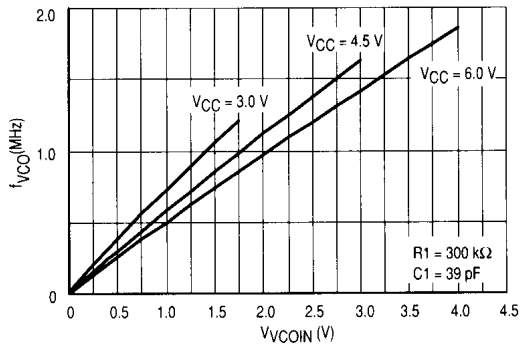

Figure 12C. VCO Frequency (f_{VCO}) as a Function of the VCO Input Voltage (V_{VCOIN})

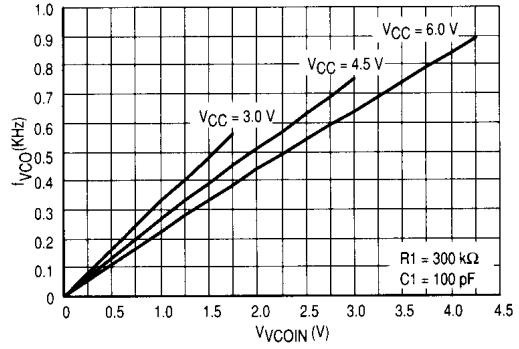

Figure 12D. VCO Frequency (f_{VCO}) as a Function of the VCO Input Voltage (V_{VCOIN})

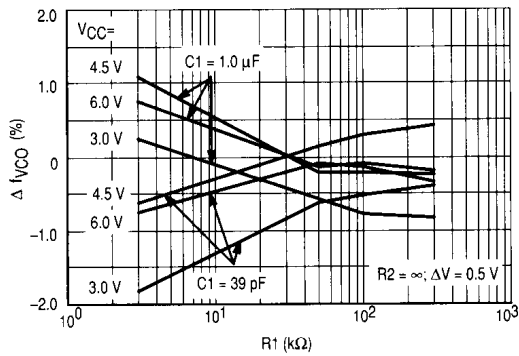

Figure 13A. Frequency Linearity versus $R1, C1$ and V_{CC}

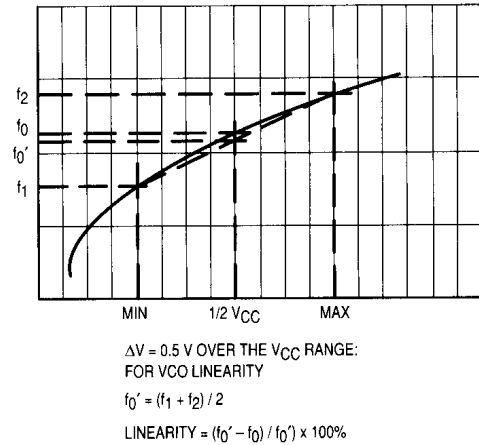

Figure 13B. Definition of VCO Frequency Linearity)