

LOW DROPOUT VOLTAGE REGULATOR

■ GENERAL DESCRIPTION

The NJM2845 is low dropout voltage regulator. Advanced Bipolar technology achieves low noise, high ripple rejection and low quiescent current.

NJM2845 is 3 terminal type and NJM2846 is ON/OFF control built in type. These product can be selected according to the applications.

■ PACKAGE OUTLINE

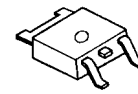

NJM2845DL1

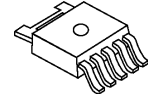

NJM2846DL3

■ FEATURES

- High Ripple Rejection 75dB typ. (f=1kHz,3V Version)
- Output Noise Voltage V_{no}=45μV_{rms} typ. (V_o=3V Version)
- Output capacitor with 2.2μF ceramic capacitor (V_o≥2.6V)
- Output Current I_o(max.)=800mA
- High Precision Output V_o ±1.0%
- Low Dropout Voltage 0.18V typ. (I_o=500mA)
- ON/OFF Control (NJM2846)
- Internal Short Circuit Current Limit
- Internal Thermal Overload Protection
- Bipolar Technology
- Package Outline TO-252-3 (NJM2845DL1), TO-252-5 (NJM2846DL3)

■ PIN CONFIGURATION

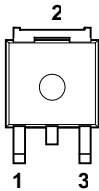

NJM2845DL1

- 1.V_{IN}
- 2.GND
- 3.V_{OUT}

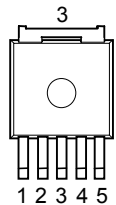

NJM2846DL3

- 1.CONTROL
- 2.V_{IN}
- 3.GND
- 4.V_o
- 5.NC

■ EQUIVALENT CIRCUIT

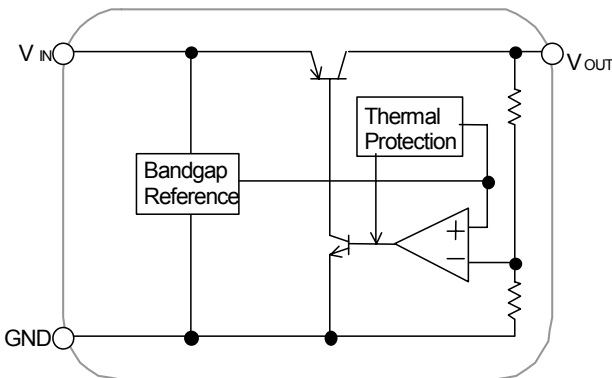

NJM2845DL1

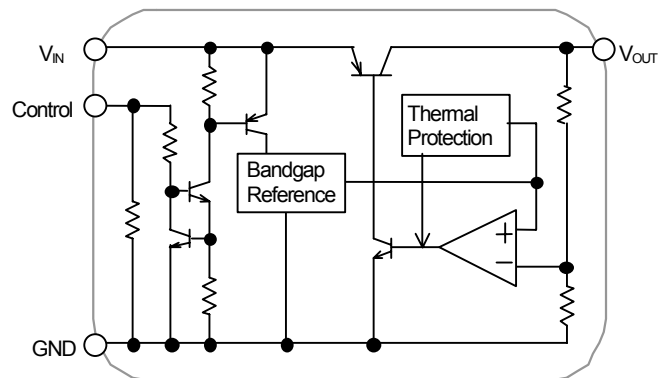

NJM2846DL3

NJM2845/46

[查询"NJM2845DL1"供应商](#)

■ OUTPUT VOLTAGE RANK LIST

Device Name	V _{OUT}
NJM284*DL*-18	1.8V
NJM284*DL*-23	2.3V
NJM284*DL*-25	2.5V
NJM284*DL*-03	3.0V
NJM284*DL*-33	3.3V
NJM284*DL*-05	5.0V

■ ABSOLUTE MAXIMUM RATINGS (Ta=25°C)

PARAMETER	SYMBOL	RATINGS	UNIT
Input Voltage	V _{IN}	+14	V
Control Voltage	V _{CONT}	+14(*1)	V
Power Dissipation	P _D	10(Tc≤25°C) 1.0(Ta≤25°C)	W
Operating Temperature	Topr	-40 ~ +85	°C
Storage Temperature	Tstg	-40 ~ +150	°C

(*1): When input voltage is less than +14V, the absolute maximum control voltage is equal to the input voltage.

■ Operating voltage

$$V_{IN}=+2.5V(\text{In case of } V_o < 2.3V) \sim +(V_o+10V)$$

■ NJM2845

■ ELECTRICAL CHARACTERISTICS (V_{IN}=V_o+1V, C_{IN}=0.33μF, C_o=2.2μF(V_o≤2.6V: C_o=4.7μF), Ta=25°C)

PARAMETER	SYMBOL	TEST CONDITION	MIN.	TYP.	MAX.	UNIT
Output Voltage	V _o	I _o =30mA	-1.0%	-	+1.0%	V
Quiescent Current	I _Q	I _o =0mA	-	400	600	μA
Output Current	I _o	V _o - 0.3V	800	1050	-	mA
Line Regulation	ΔV _o /ΔV _{IN}	V _{IN} =V _o +1V ~ V _o +6V, I _o =30mA	-	-	0.10	%/V
Load Regulation	ΔV _o /ΔI _o	I _o =0 ~ 800mA	-	-	0.004	%/mA
Dropout Voltage(*2)	ΔV _{I-O}	I _o =500mA	-	0.18	0.28	V
Ripple Rejection	RR	e _{in} =200mVrms, f=1kHz, I _o =10mA, V _o =3V Version	-	75	-	dB
Average Temperature Coefficient of Output Voltage	ΔV _o /ΔTa	Ta=0 ~ 85°C, I _o =10mA	-	± 50	-	ppm/°C
Output Noise Voltage	V _{NO}	f=10Hz ~ 80kHz, I _o =10mA, V _o =3V Version	-	45	-	μVrms

(*2): The output voltage excludes under 2.3V.

The above specification is a common specification for all output voltages.

Therefore, it may be different from the individual specification for a specific output voltage.

[查询"NJM2845DL1"供应商](#)

POWER DISSIPATION vs. AMBIENT TEMPERATURE

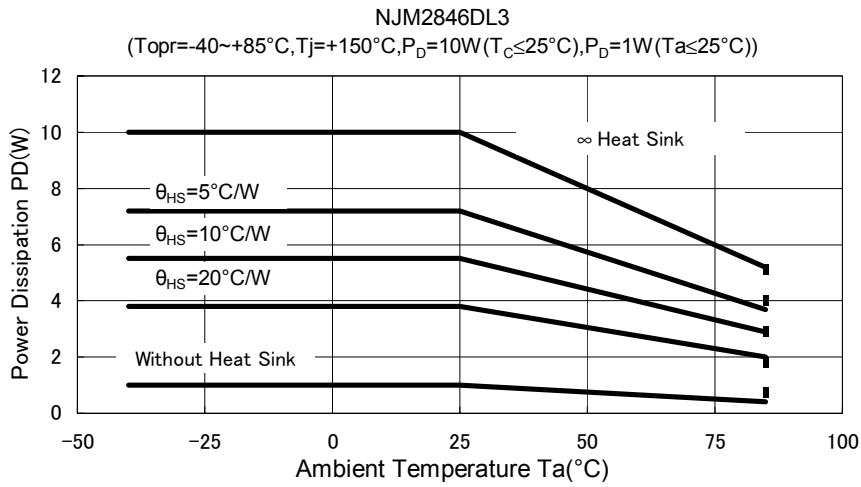

TEST CIRCUIT

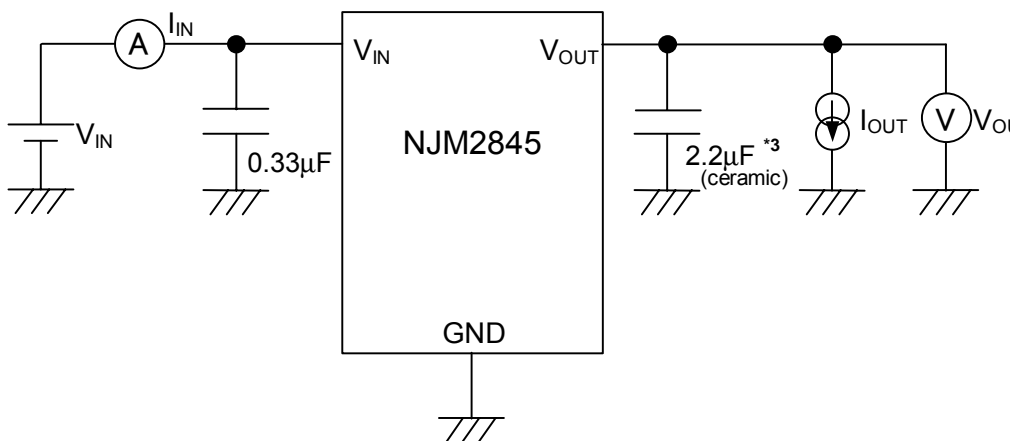

*3 $V_o \leq 2.6\text{V}$ version: $C_o = 4.7\mu\text{F}$ (ceramic)

TYPICAL APPLICATION

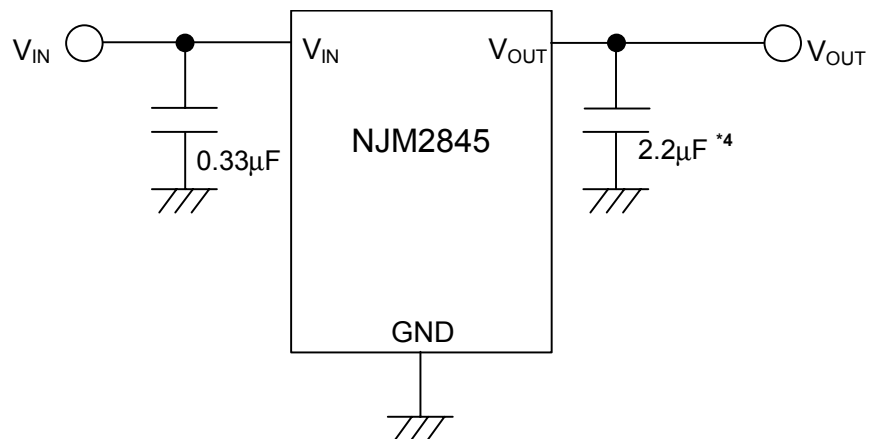

*4 $V_o \leq 2.6\text{V}$ version: $C_o = 4.7\mu\text{F}$

NJM2845/46

[查询"NJM2845DL1"供应商](#)

■ NJM2846

■ ELECTRICAL CHARACTERISTICS ($V_{IN}=V_o+1V$, $C_{IN}=0.33\mu F$, $C_o=2.2\mu F$ ($V_o\leq 2.6V$: $C_o=4.7\mu F$), $T_a=25^\circ C$)

PARAMETER	SYMBOL	TEST CONDITION	MIN.	TYP.	MAX.	UNIT
Output Voltage	V_o	$I_o=30mA$	-1.0%	-	+1.0%	V
Quiescent Current	I_Q	$I_o=0mA$	-	400	600	μA
Quiescent Current at Control OFF	$I_{Q(OFF)}$	$V_{CONT}=0V$	-	-	100	nA
Line Regulation	I_o	$V_o - 0.3V$	800	1050	-	mA
Line Regulation	$\Delta V_o/\Delta V_{IN}$	$V_{IN}=V_o+1V \sim V_o+6V$, $I_o=30mA$	-	-	0.10	%/V
Load Regulation	$\Delta V_o/\Delta I_o$	$I_o=0 \sim 800mA$	-	-	0.004	%/mA
Dropout Voltage(*5)	ΔV_{I-O}	$I_o=500mA$	-	0.18	0.28	V
Ripple Rejection	RR	$e_{in}=200mV_{rms}$, $f=1kHz$, $I_o=10mA$, $V_o=3V$ Version	-	75	-	dB
Average Temperature Coefficient of Output Voltage	$\Delta V_o/\Delta T_a$	$T_a=0 \sim 85^\circ C$, $I_o=10mA$	-	± 50	-	ppm/ $^\circ C$
Output Noise Voltage	V_{NO}	$f=10Hz \sim 80kHz$, $I_o=10mA$, $V_o=3V$ Version	-	45	-	μV_{rms}
Control Current	I_{CONT}	$V_{CONT}=1.6V$, $I_o=0mA$	-	3	12	μA
Control Voltage for ON-state	$V_{CONT(ON)}$		1.6	-	-	V
Control Voltage for OFF-state	$V_{CONT(OFF)}$		-	-	0.6	V

(*5): The output voltage excludes under 2.3V.

The above specification is a common specification for all output voltages.

Therefore, it may be different from the individual specification for a specific output voltage.

■ POWER DISSIPATION vs. AMBIENT TEMPERATURE

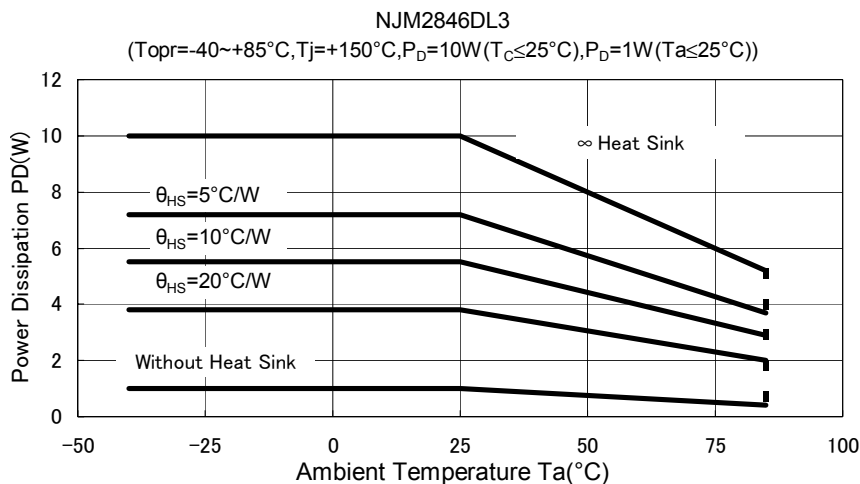

[查询"NJM2845DL1"供应商](#)

■ TEST CIRCUIT

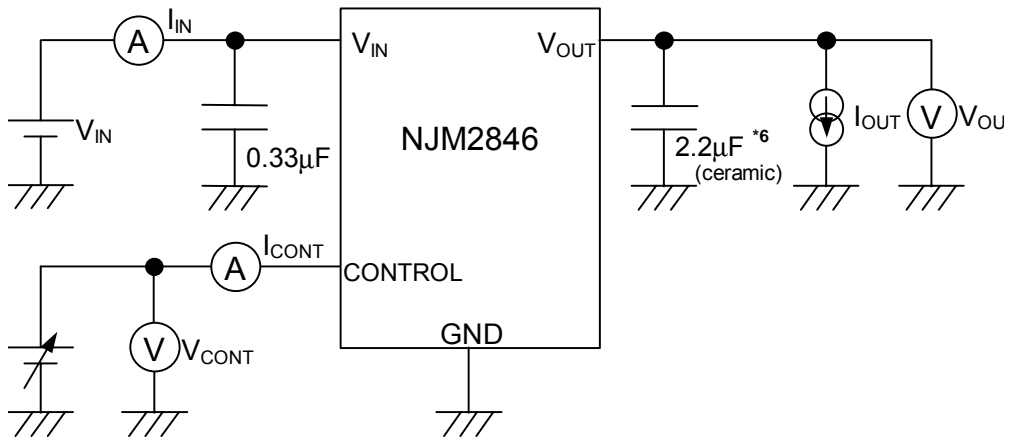

*6 $V_o \leq 2.6V$ version: $C_o = 4.7\mu F$ (ceramic)

NJM2845/46

[查询"NJM2845DL1"供应商](#)

■ TYPICAL APPLICATION

① In the case where ON/OFF Control is not required:

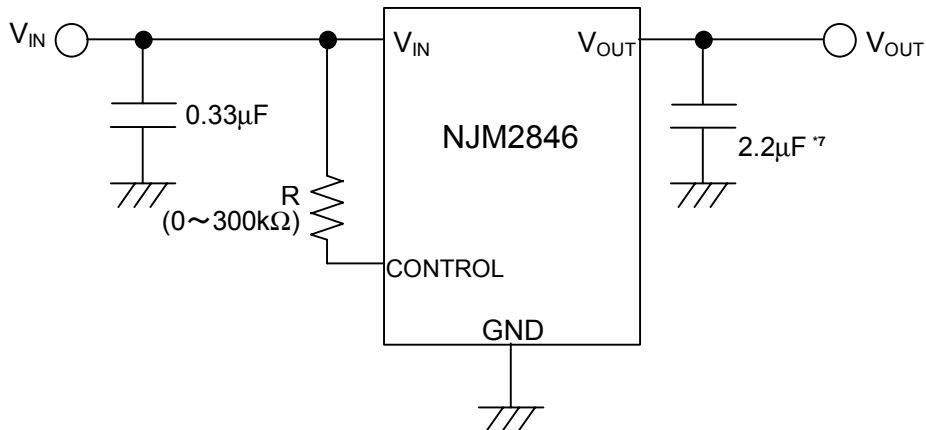

*7 $V_o \leq 2.6V$ version: $C_o = 4.7\mu F$

Connect control terminal to V_{IN} terminal

The quiescent current can be reduced by using a resistance "R". Instead, it increases the minimum operating voltage. For further information, please refer to Figure "Output Voltage vs. Control Voltage".

② In use of ON/OFF CONTROL:

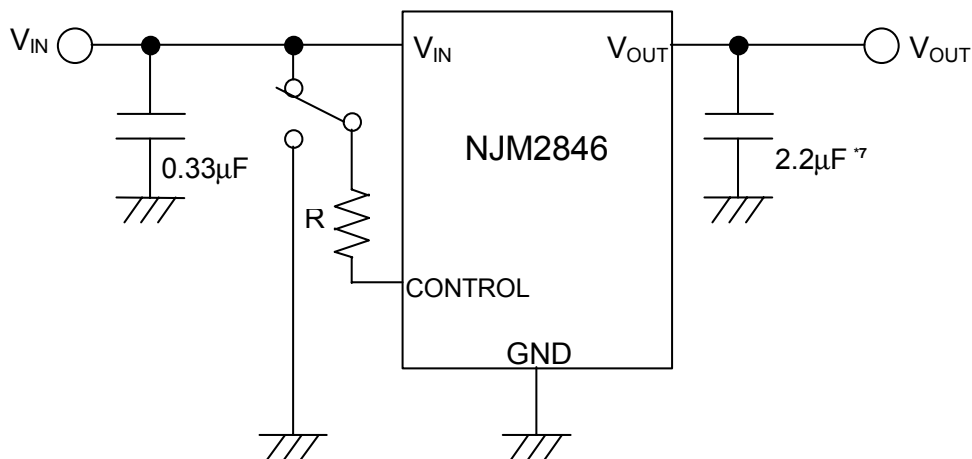

*7 $V_o \leq 2.6V$ version: $C_o = 4.7\mu F$

State of control terminal:

- "H" → output is enabled.
- "L" or "open" → output is disabled.

查询"NJM2845DL1"供应商

■ TYPICAL CHARACTERISTICS (NJM2845)

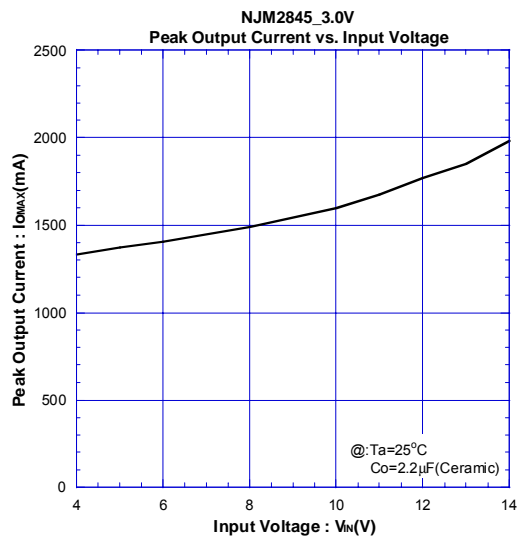
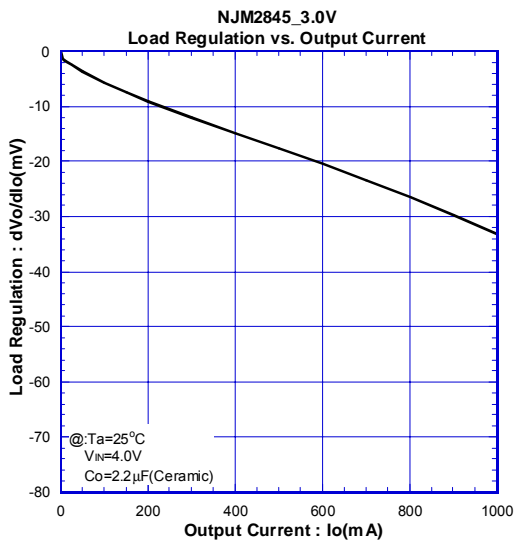
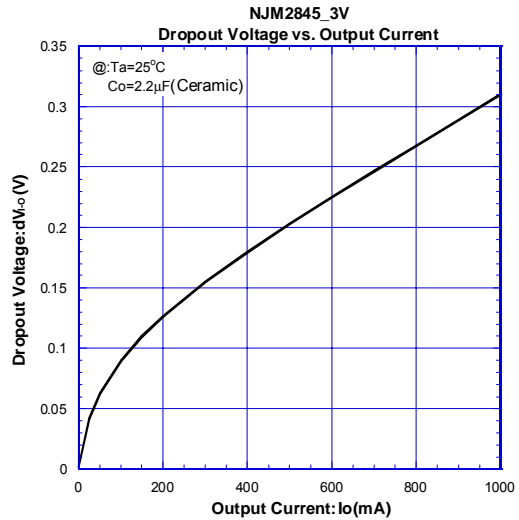
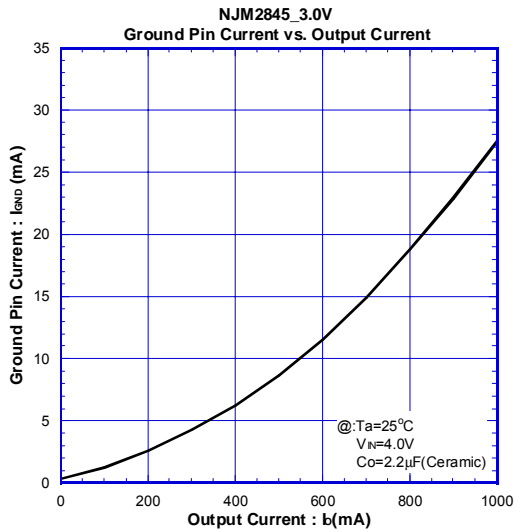
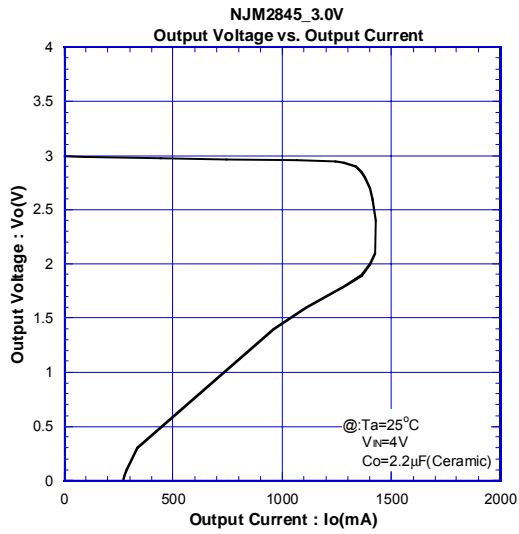
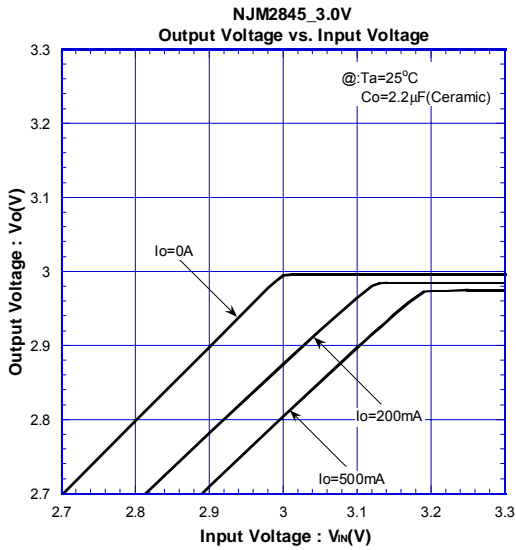

NJM2845/46

查询"NJM2845DL1"供应商

■ TYPICAL CHARACTERISTICS (NJM2845)

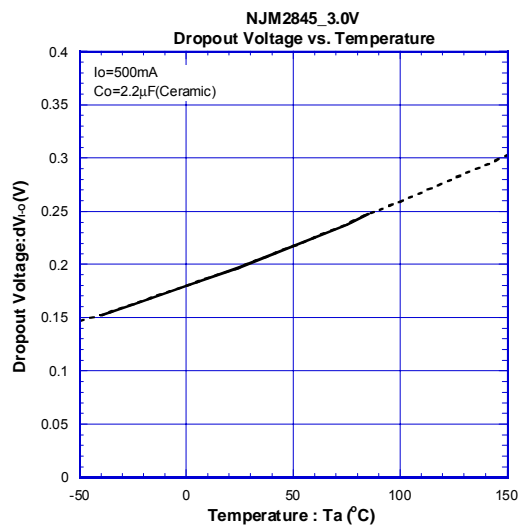
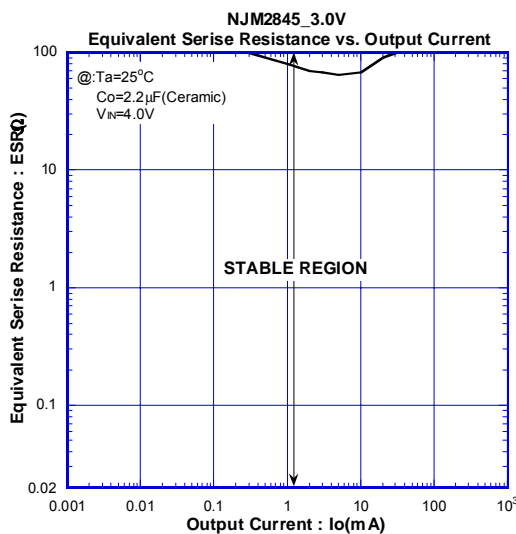
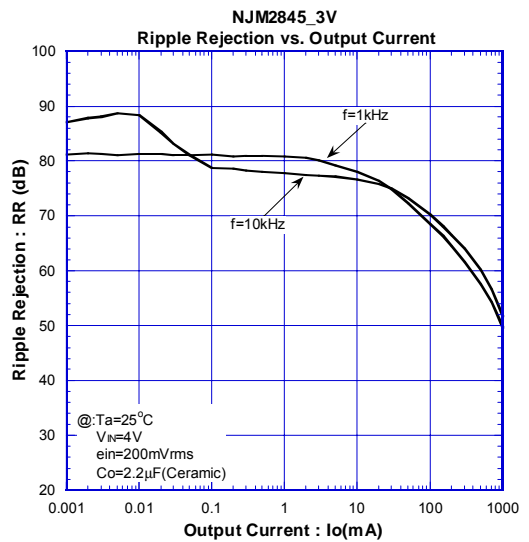
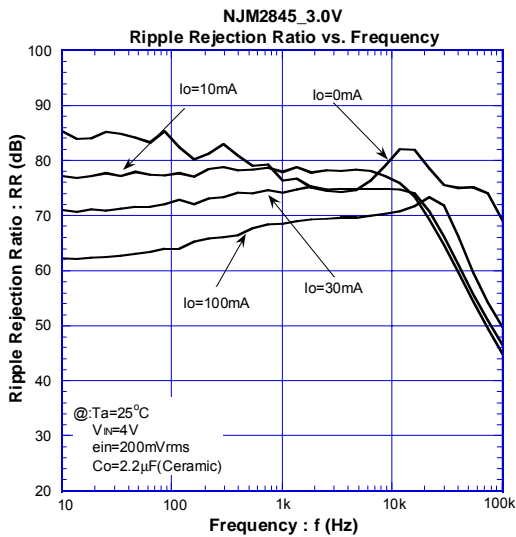
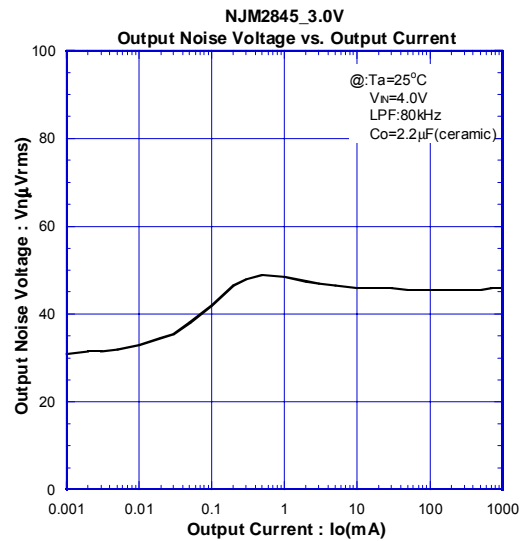
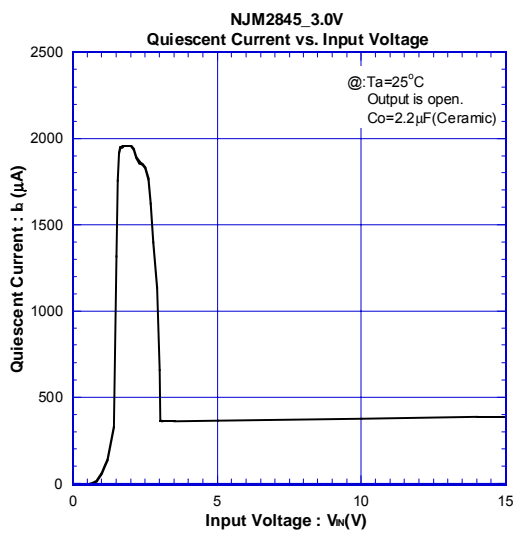

查询"NJM2845DL1"供应商

TYPICAL CHARACTERISTICS (NJM2845)

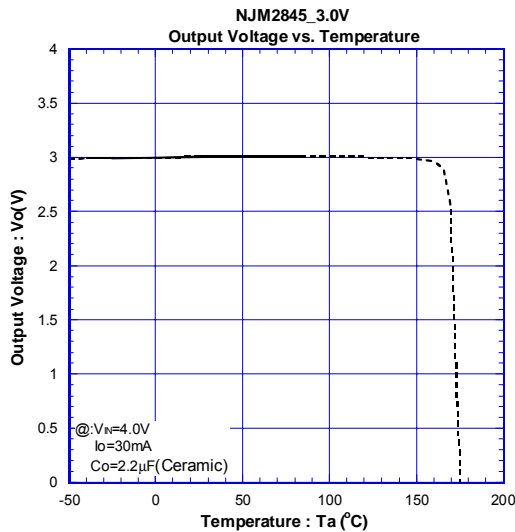
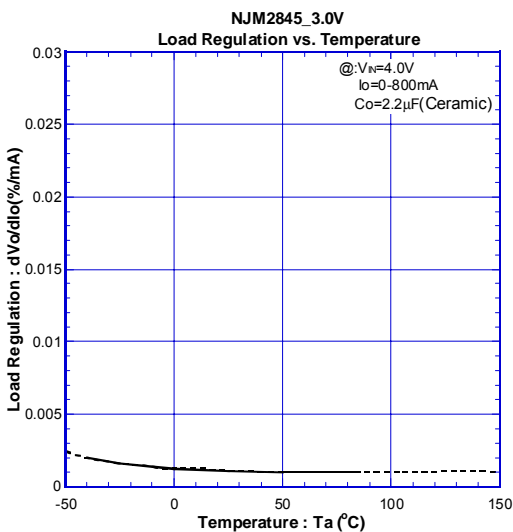
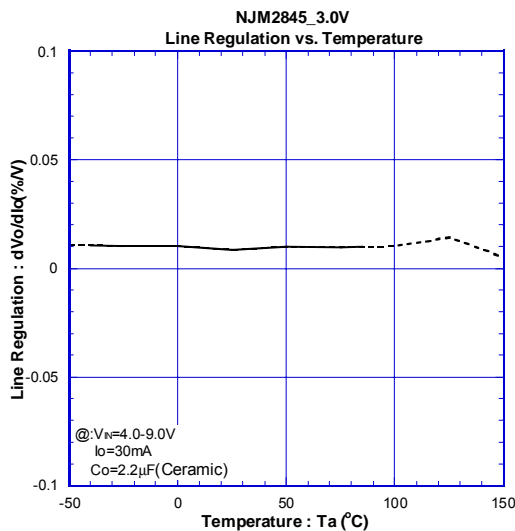
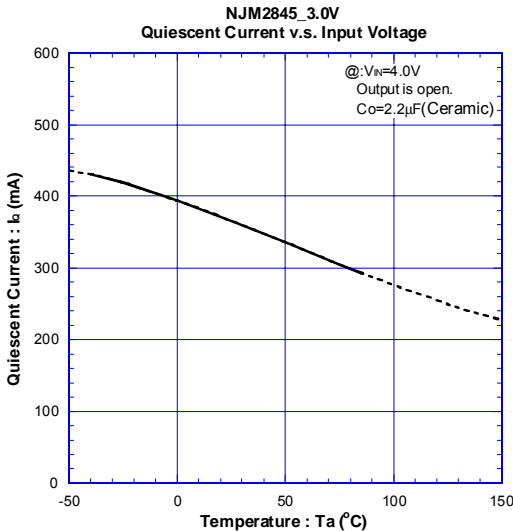
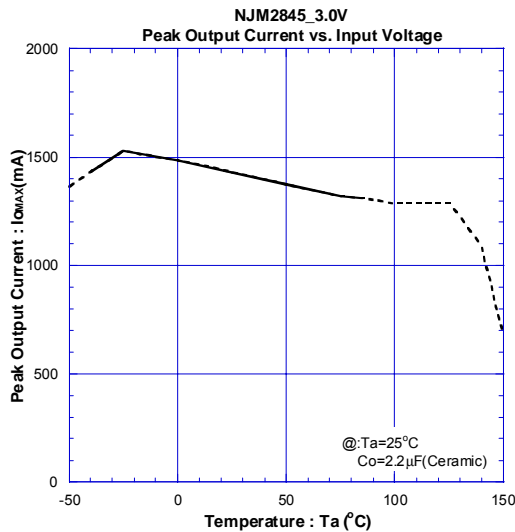
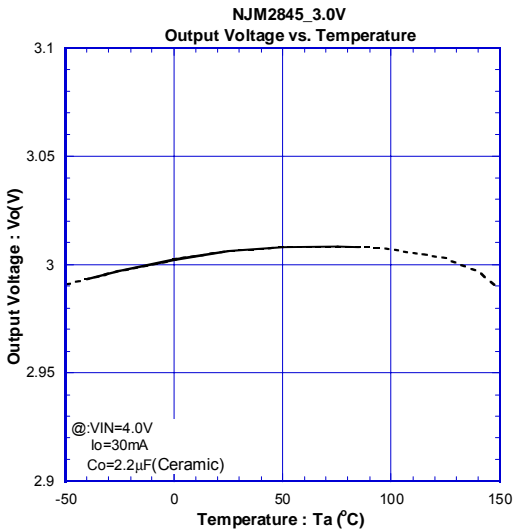

NJM2845/46

[查询"NJM2845DL1"供应商](#)

■ TYPICAL CHARACTERISTICS (NJM2845)

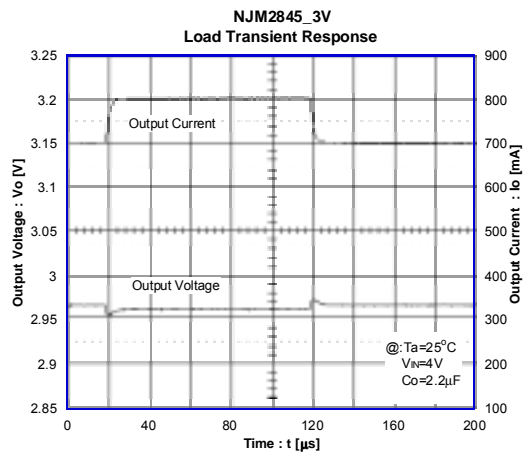
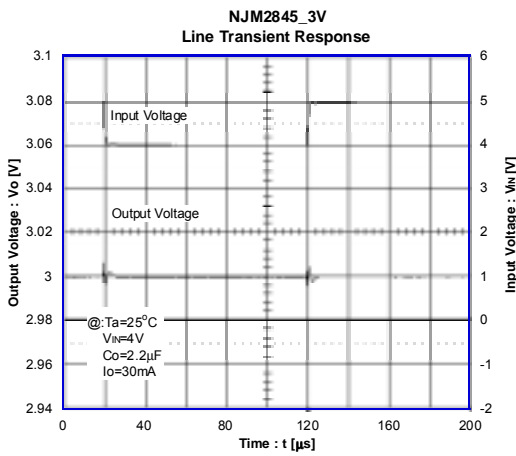
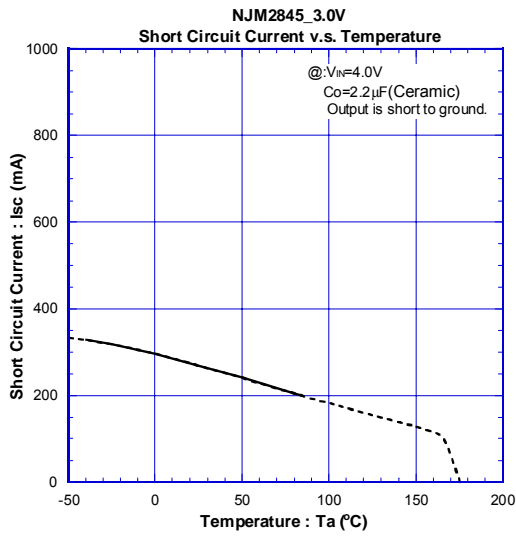

查询"NJM2845DL1"供应商

TYPICAL CHARACTERISTICS (NJM2846)

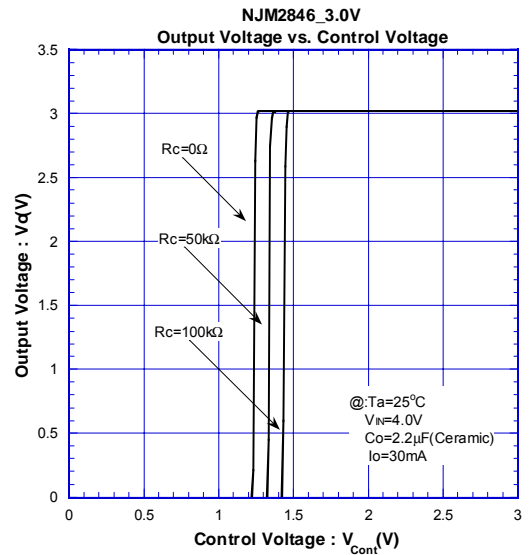
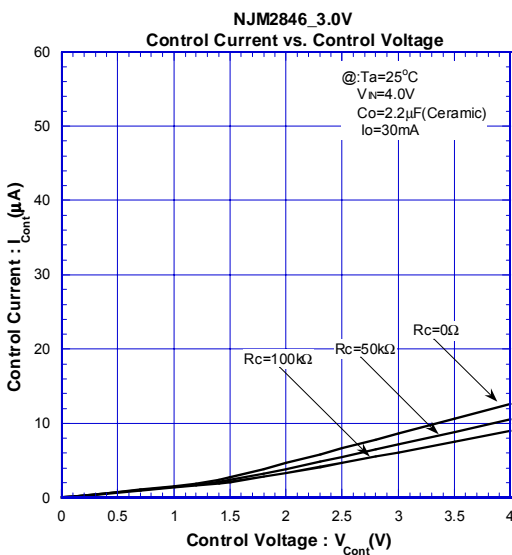
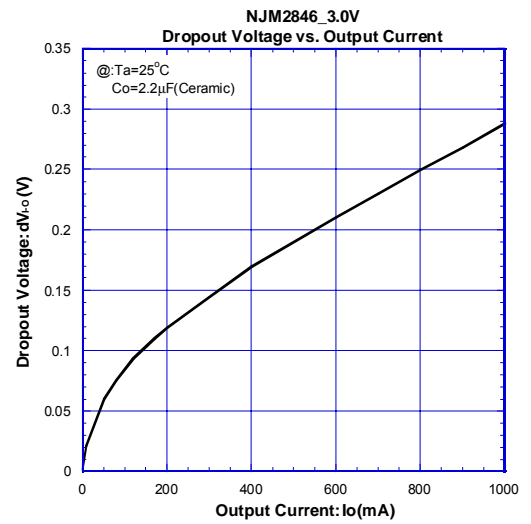
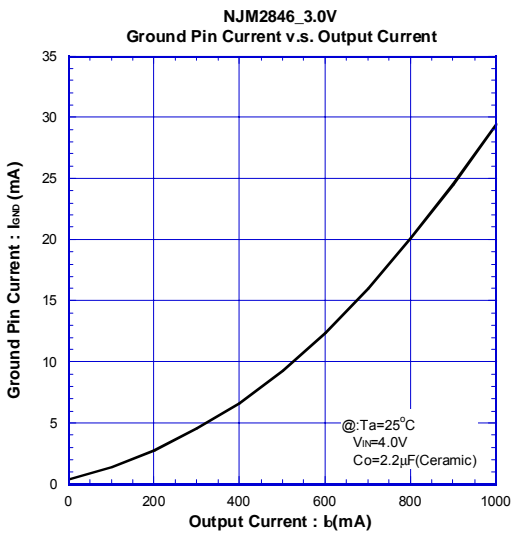
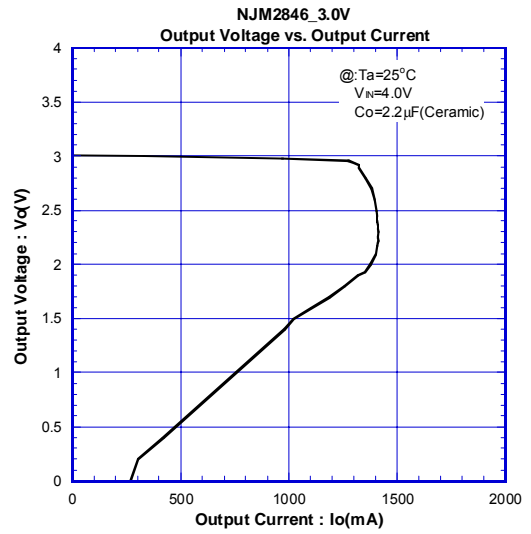
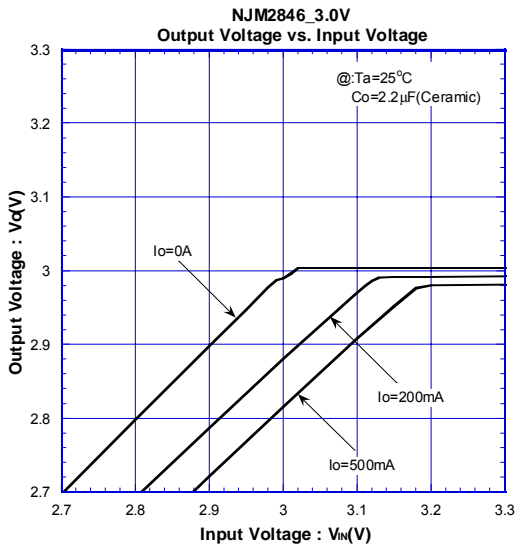

NJM2845/46

查询"NJM2845DL1"供应商

■ TYPICAL CHARACTERISTICS (NJM2846)

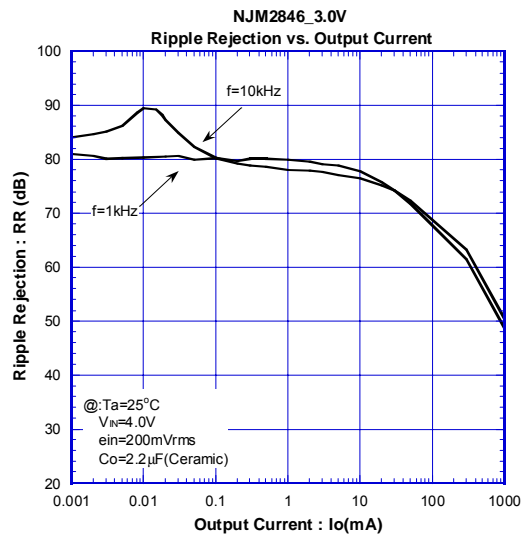
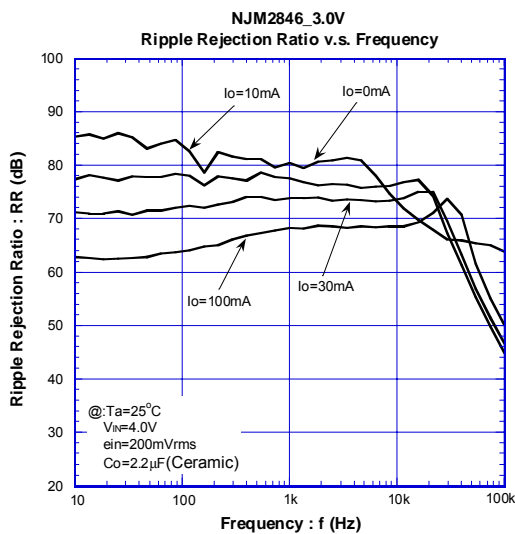
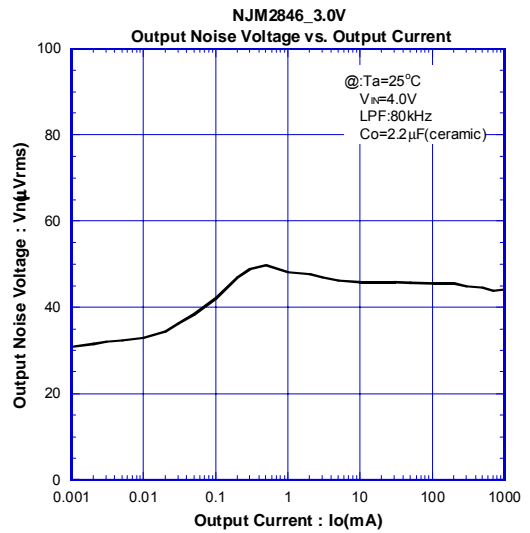
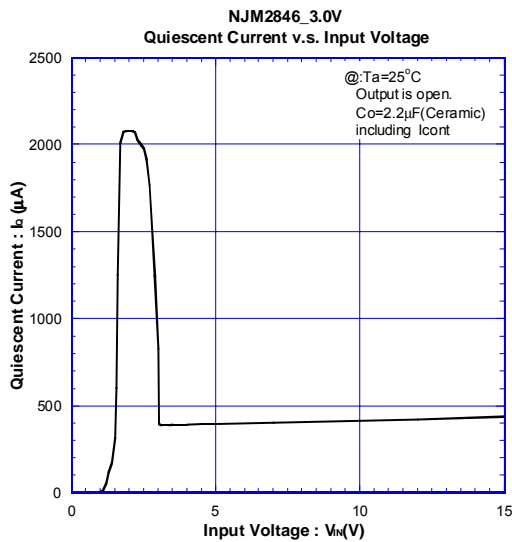
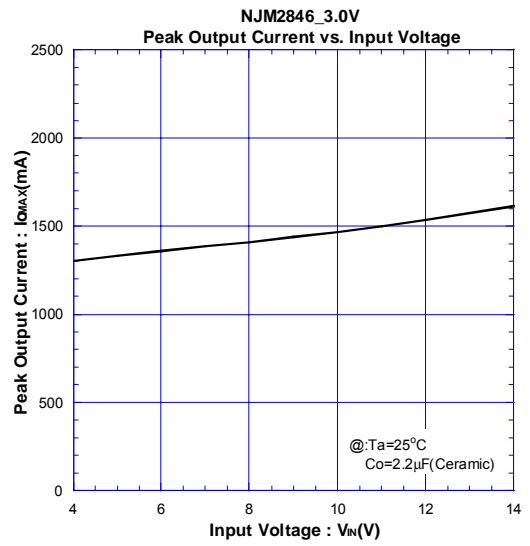
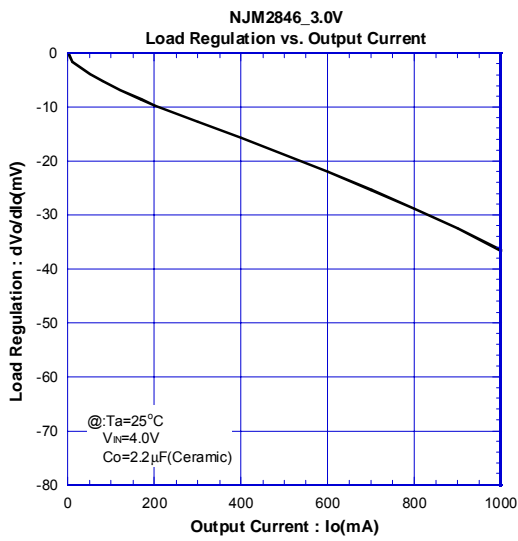

查询"NJM2845DL1"供应商

■ TYPICAL CHARACTERISTICS (NJM2846)

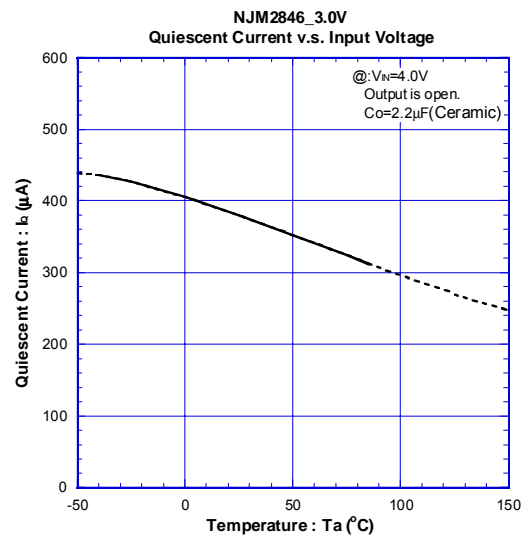
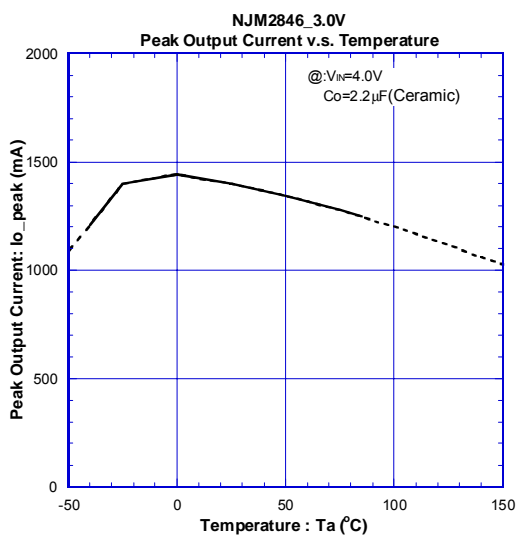
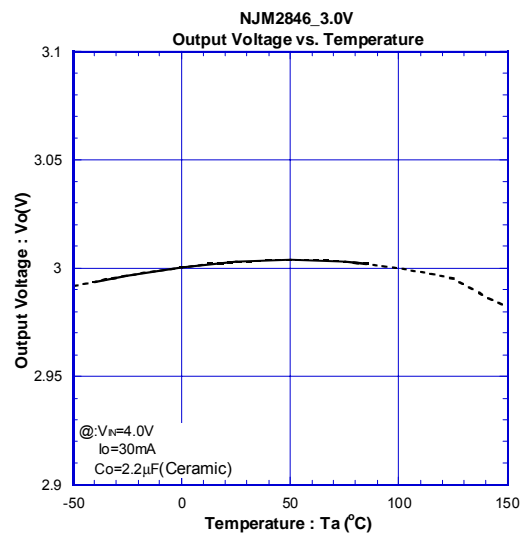
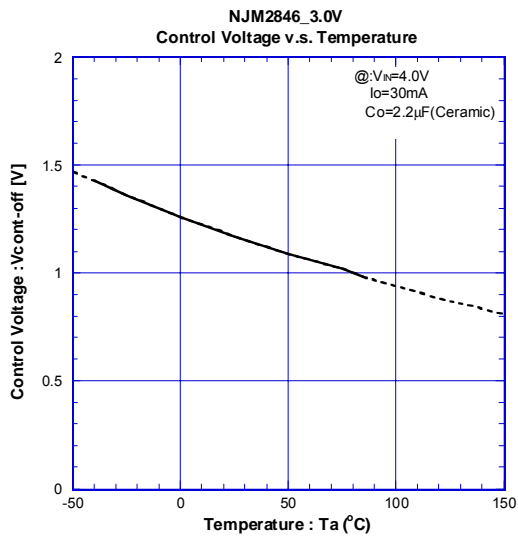
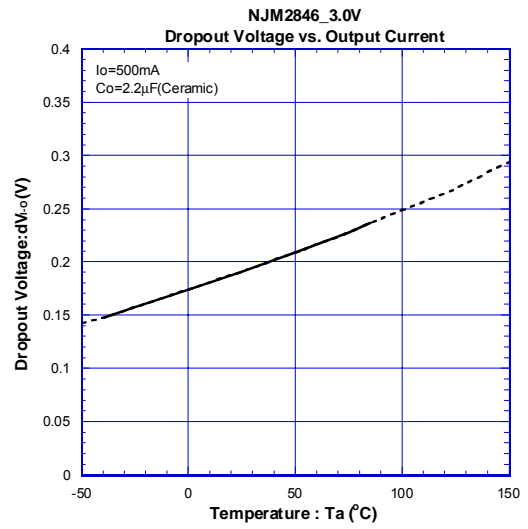
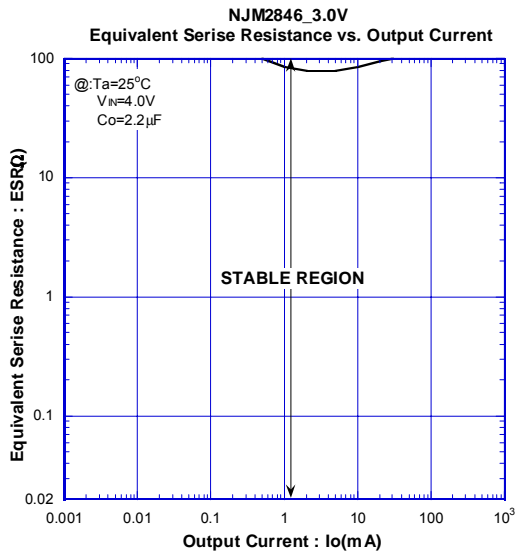

NJM2845/46

[查询"NJM2845DL1"供应商](#)

■ TYPICAL CHARACTERISTICS (NJM2846)

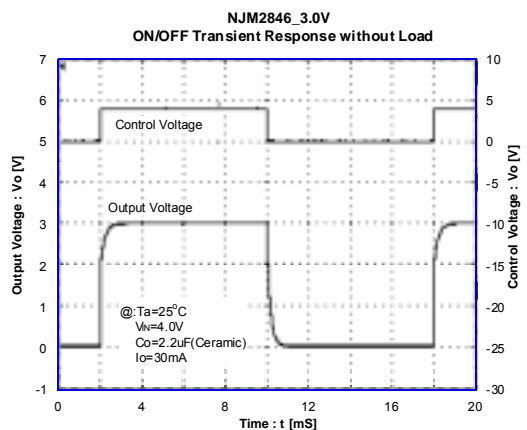
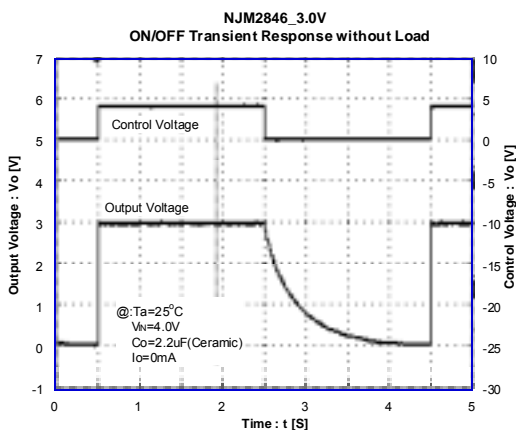
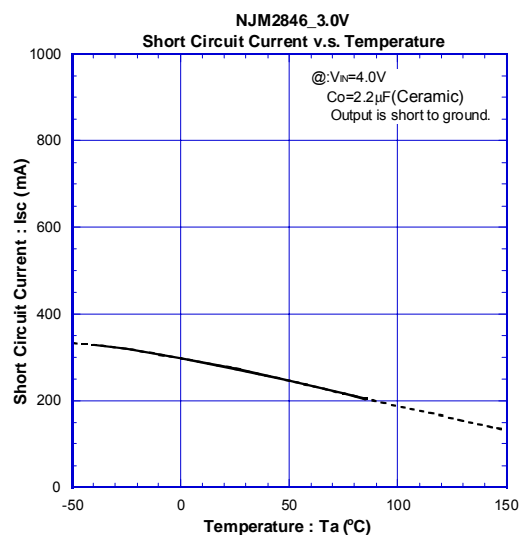
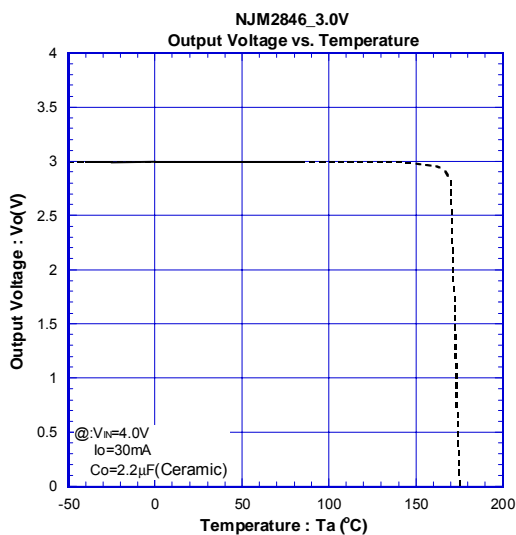
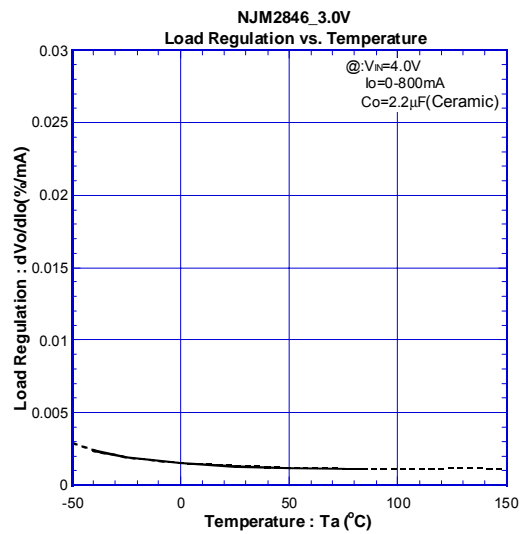
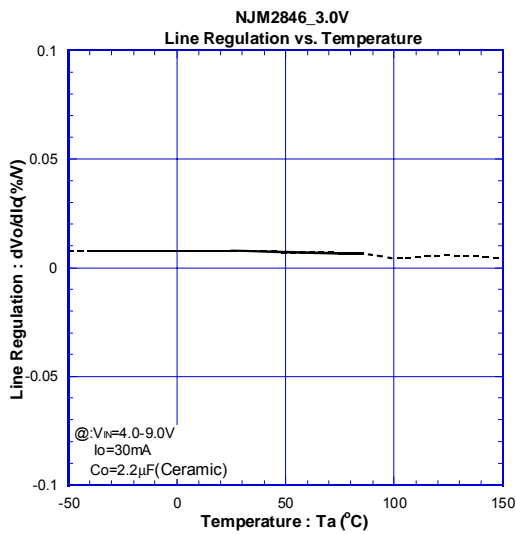

[查询"NJM2845DL1"供应商](#)

■ TYPICAL CHARACTERISTICS (NJM2846)

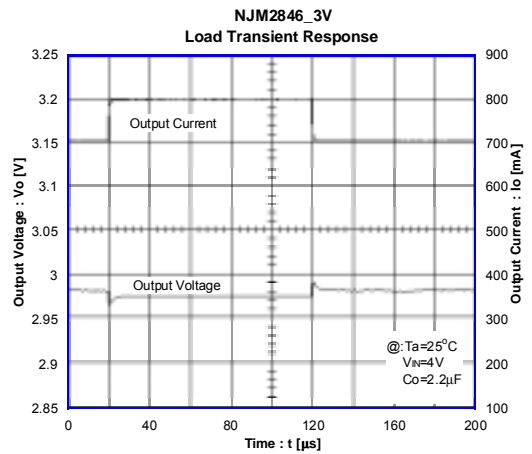
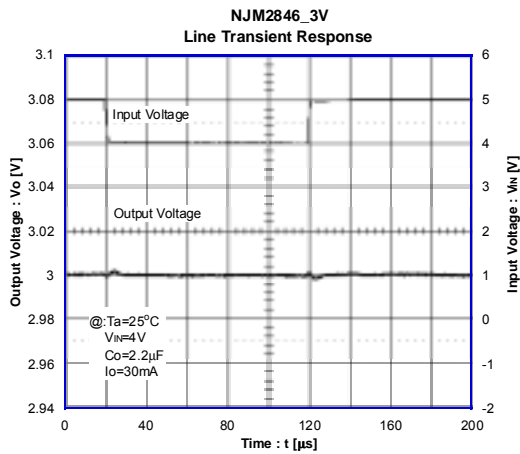

[CAUTION]

The specifications on this databook are only given for information, without any guarantee as regards either mistakes or omissions. The application circuits in this databook are described only to show representative usages of the product and not intended for the guarantee or permission of any right including the industrial rights.