

SF1080A

**499.25 MHz
SAW Filter**

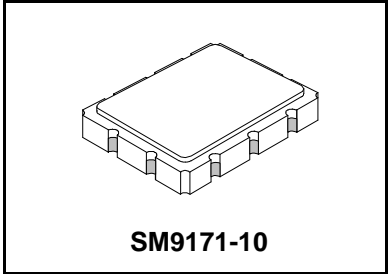

- **Designed for CATV Applications (Pilot Tone)**
- **Tightly Controlled Insertion Loss**
- **9.1 x 7.1 mm Surface-Mount Case**
- **Unbalanced Input and Output**
- **Complies with Directive 2002/95/EC (RoHS)** 

Absolute Maximum Ratings

Rating	Value	Units
Maximum Incident Power in Passband	+10	dBm
Max. DC voltage between any 2 terminals	30	VDC
Storage Temperature Range	-54 to +85	°C
Suitable for lead-free soldering - Max Soldering Profile	260°C for 30 s	

Electrical Characteristics

Characteristic	Sym	Notes	Min	Typ	Max	Units
Nominal Center Frequency	f_c	1	499.250			MHz
Passband Insertion Loss at f_c 0.5 dB Passband 3 dB Passband Amplitude Ripple over $f_c \pm 100$ kHz	IL	1, 2	6.0	7.5	9.0	dB
	$BW_{0.5}$		± 100			kHz
	BW_3		± 800	± 970		dB _{P-P}
Rejection $f_c - 200$ to $f_c - 3.0$ and $f_c + 3.0$ to $f_c + 200$ MHz Ultimate		1, 2, 3	35		0.5	dB
			40			
Operating Temperature Range	T_A	1	-25		+75	°C

Impedance Matching to 50 Ω unbalanced	External L-C				
Case Style	SM9171-10	9.1 x 7.1 mm Nominal Footprint			
Lid Symbolization (XX = 2 character date code)	RFM SF1080A XX				

Electrical Connections

Connection	Terminals
Port 1 Hot	10
Port 1 Gnd Return	1
Port 2 Hot	5
Port 2 Gnd Return	6
Case Ground	All others

Notes:

1. Unless noted otherwise, all specification apply over the operating temperature range with filter soldered to the specified demonstration board with impedanced matching to 50 Ω network analyzer.
2. Unless noted otherwise, all frequency specifications are referenced to the nominal center frequency, f_c .
3. Rejection is measured as attenuation below the minimum IL point in the passband. Rejection in final user application is dependent on PCB layout and external impedance matching design. See Application Note No. 42 for details.
4. "LRIP" or "L" after the part number indicates "low rate initial production" and "ENG" or "E" indicates "engineering prototypes."
5. The design, manufacturing process, and specifications of this filter are subject to change.
6. Either Port 1 or Port 2 may be used for either input or output in the design. However, impedances and impedance matching may vary between Port 1 and Port 2, so that the filter must always be installed in one direction per the circuit design.
7. US and international patents may apply.
8. RFM, stylized RFM logo, and RF Monolithics, Inc. are registered trademarks of RF Monolithics, Inc.
9. Electrostatic Sensitive Device. Observe precautions for handling. 

[查询"SF1080A"供应商](#)

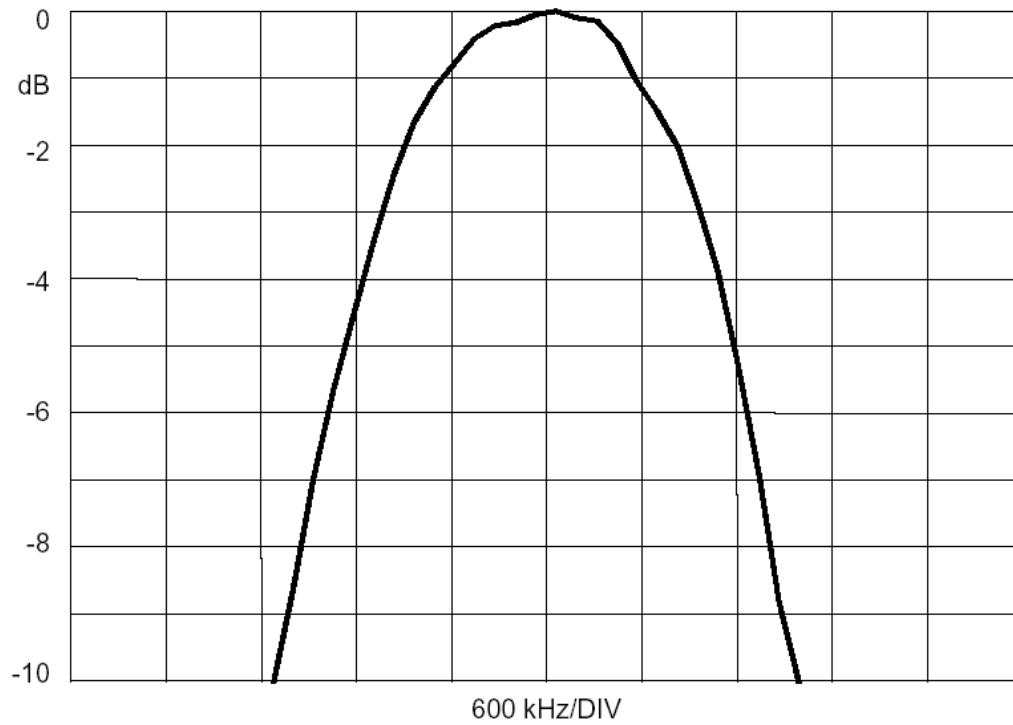
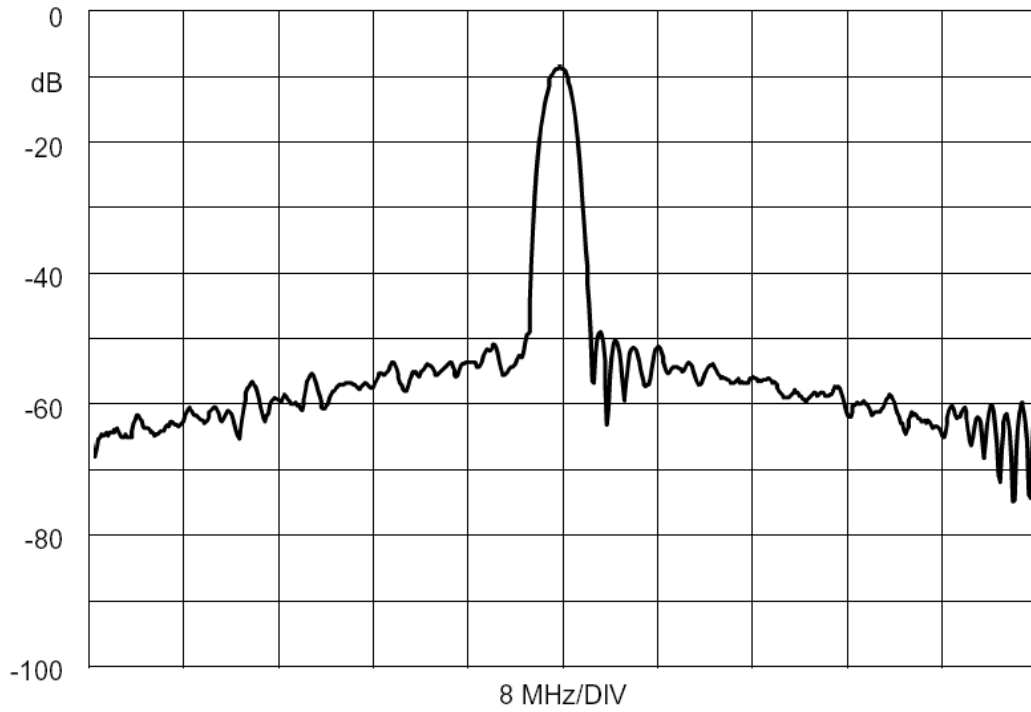

SM9171-10 Case

10-Terminal Ceramic Surface-Mount Case
9.1 x 7.1 mm Nominal Footprint

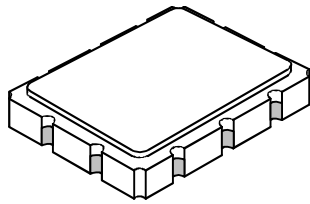

Case Dimensions						
Dimension	mm			Inches		
	Min	Nom	Max	Min	Nom	Max
A	8.86	9.09	9.40	0.349	0.358	0.370
B	6.88	7.11	7.40	0.271	0.280	0.291
C		1.91	2.00		0.075	0.079
D		0.99			0.039	
E		0.79			0.031	
H		1.0			0.039	
P		2.54			0.100	

Materials	
Solder Pad Termination	Au plating 30 - 60 μinches (76.2-152 μm) over 80-200 μinches (203-508 μm) Ni.
Lid	Fe-Ni-Co Alloy Electroless Nickel Plate (8-11% Phosphorus) 100-200 μinches Thick
Body	Al ₂ O ₃ Ceramic
Pb Free	

Electrical Connections		
Connection		Terminals
Port 1	Input or Return	6
	Return or Input	5
Port 2	Output or Return	1
	Return or Output	10
Ground		All others
Single Ended Operation		Return is ground
Differential Operation		Return is hot

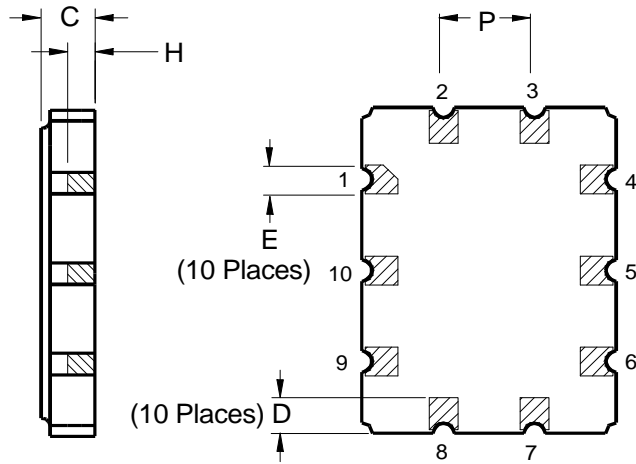
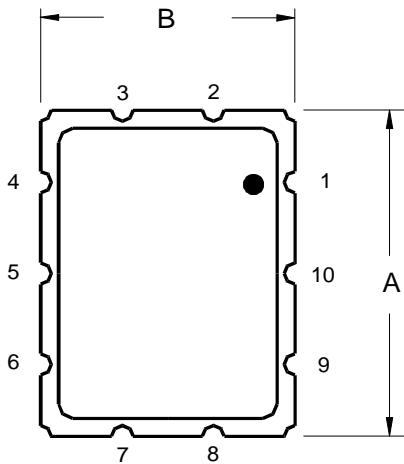

Figure #1

SF1080A
E2 N14

Ref #1

Demol

B.C

7/7/98

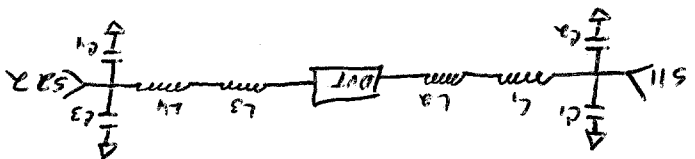
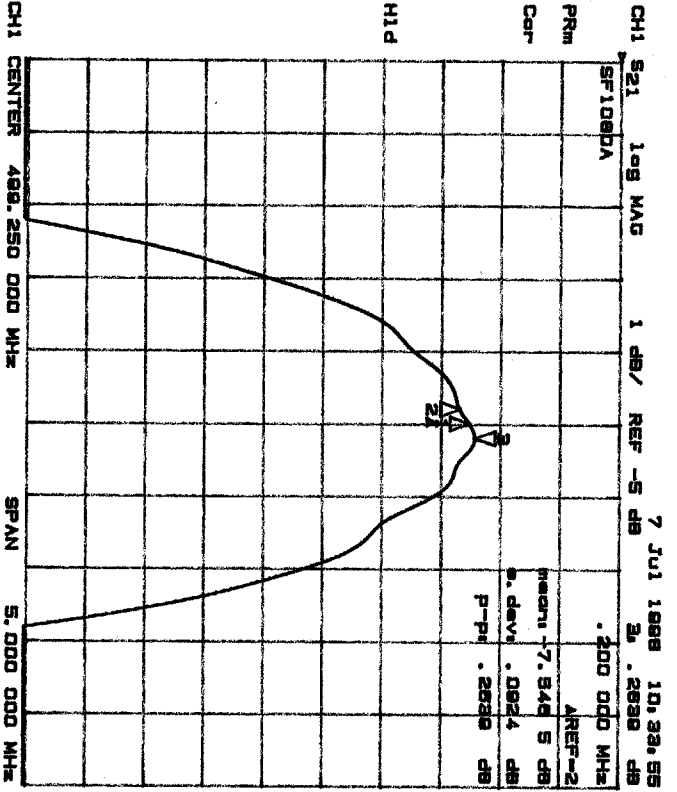
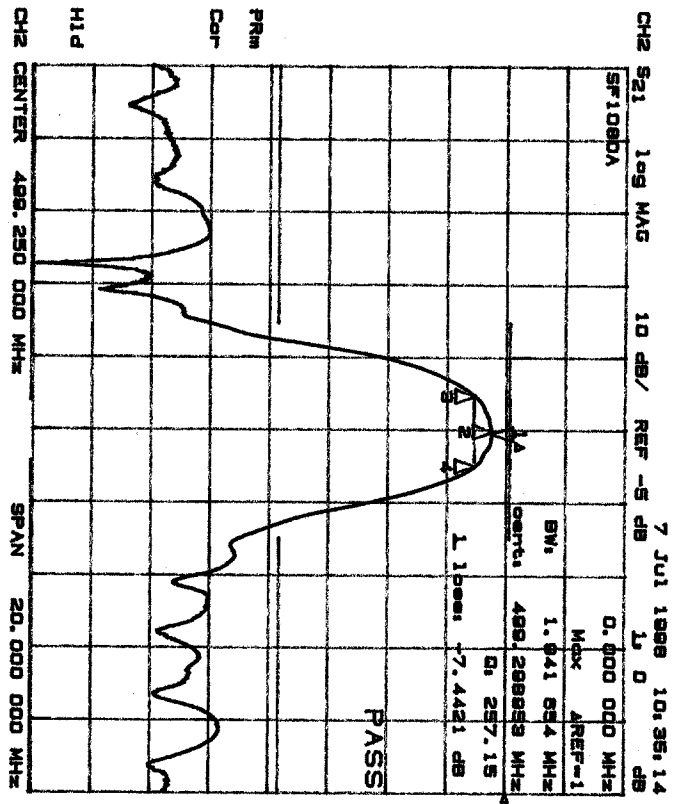

- C1 = 1.9 pF
- C2 = 12 pF
- C3 = 20 pF
- C4 = 12 pF
- L1 = 1.2 nH
- L2 = 12 nH
- L3 = 15 nH
- L4 = 1.5 nH

[查询"SF1080A"供应商](#)

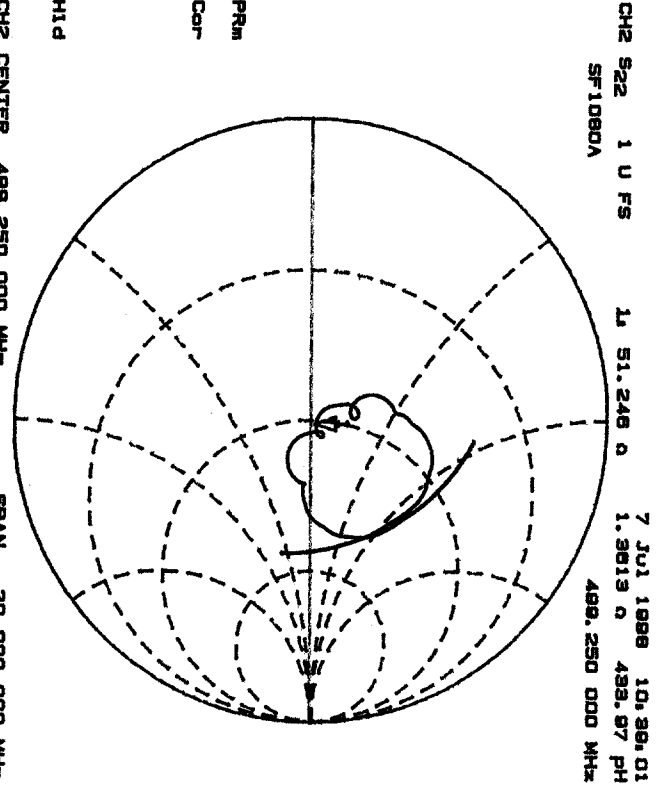
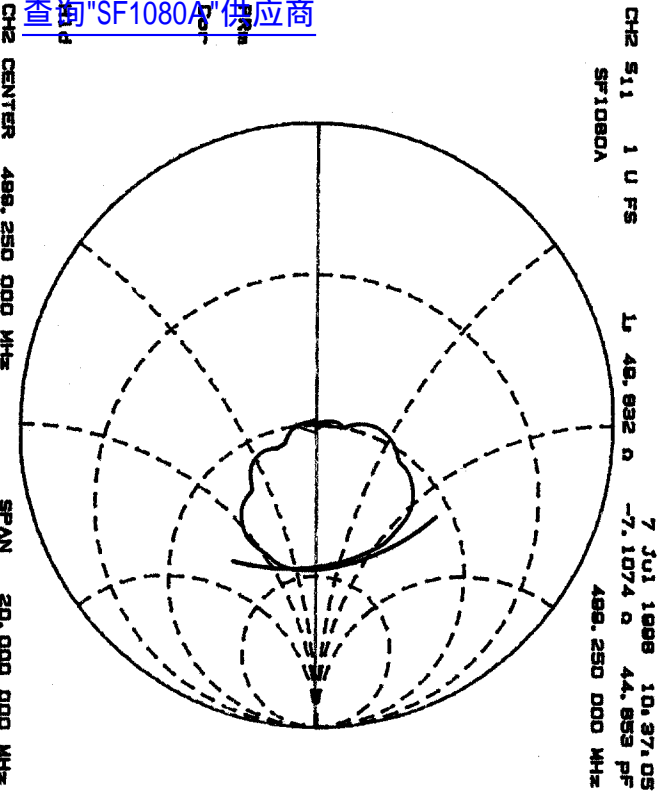

SF1080A-000

4/4

BILL OF MATERIALS

查询"SF1080A"供应商

<u>PART IDENTIFIER</u>	<u>DESCRIPTION 1</u>	<u>DESCRIPTION 2</u>	<u>QTY/ASSY</u>	<u>REFERENCE DESCRIPTION</u>
SF1080A(DEMO)	DEMO BOARD,SF1080A	SF1080A	0	
SF1080A-000	ASSY DIAGRAM,DEMO BOARD	GENERAL INSTRUMENT	1.0000	FLTR1
SF1080A	FILTER,SM,499.250MHZ	TEST FIXTURE	1.0000	PCB1
400-0845-001	PCB, SMT FILTER		1.0000	SHLD
400-0533-001	SHIELD,TO-39 TEST FIXTURE		1.0000	C 1
500-0003-019	CAP,CHIP,NPO,1.9(J),STD		2.0000	C 2, 4
500-0003-120	CAP,CHIP,NPO,12(J), STD		1.0000	C 3
500-0003-020	CAP,CHIP,NPO,2.0(C),STD		2.0000	J 1, 2
500-0248-001	CONN,COAX,FLANGE MT.JACK	4 HOLE	1.0000	L 1
500-0815-012	IND,CHIP,0402,1.2NH, ± 0.3 NH		1.0000	L 2
500-0010-120	IND, CHIP, 1008CS, 12NH, 10%		1.0000	L 3
500-0010-150	IND, CHIP, 1008CS, 15NH, 10%		1.0000	L 4
500-0815-015	IND, CHIP, 0402, 1.5NH, ± 0.3 NH		1.0000	



SIZE **A**

FSCM NO.

2U874

DWG NO.

SF1080A(DEMO)

SCALE

NONE

W/O or ECN

7046

REV

B

SHEET

1

OF

2

REV HISTORY

REV	ECN	DATE	DESCRIPTION
A	6122	11/19/97	INITIAL RELEASE
B	7046	09/22/98	DOCUMENT UPDATE

[查询"SF1080A"供应商](#)

	SIZE	FSCM NO.	DWG NO.
	A	2U874	SF1080A(DEMO)
SCALE	W/O or ECN	REV	SHEET
NONE	7046	B	2 OF 2

REV	ECN NO.	DESCRIPTION	APP /DATE
A	6122	INITIAL RELEASE	
B	7046	CHANGE TUNING NETWORK	22SEP98
C	12221	REVISED	10jun04
C1	12298	MOVED PIN 1 DOT	29jun04

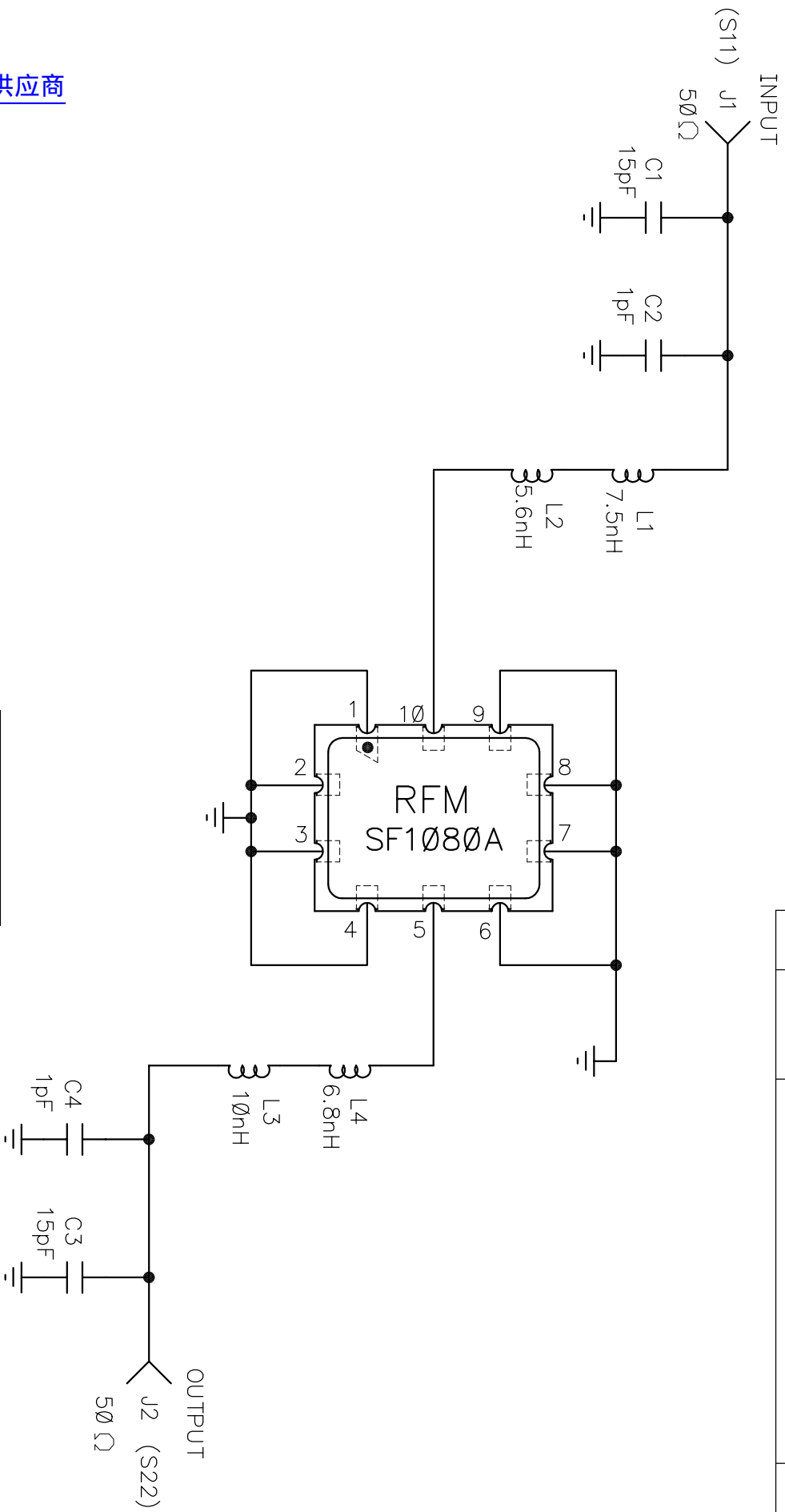

SCHEMATIC

DATE: [查询"SF1080A"供应商](#)

J.J. LAYTON 12/03/97

TITLE: ASSEMBLY DIAGRAM, SF1080A-DEMO

RF Monolithics, Inc.

ALL INFORMATION DISCLOSED BY THIS DOCUMENT IS
CONFIDENTIAL AND PROPRIETARY TO RF MONOLITHICS, INC.
ALL DESIGN, MANUFACTURE, USE, REPRODUCTION AND
SALES RIGHTS ARE RESERVED BY RF MONOLITHICS, INC.

SIZE CODE IDENT
A 2U874

DWG. NO. **SF1080A-000**

REV SHEET
C1 1/3

DALLAS, TEXAS 75244

NOTES:

1. SOLDER MOUNT COMPONENTS AND CONNECTORS TO PCB1
2. CUT PCB TRACE UNDER L1 AND L3.
3. COMPONENTS MAY NEED TO BE TRADED FOR SLIGHTLY HIGHER OR LOWER DUE TO TOLERANCE LEVELS.
4. SEE ATTACHED NOTES FOR INSTRUCTIONS ON HOW TO "FINE TUNE" ONCE DEMO IS BUILT.
5. ATTACH LABELS.
6. NOTE PROPER ORIENTATION OF SAW DEVICE.

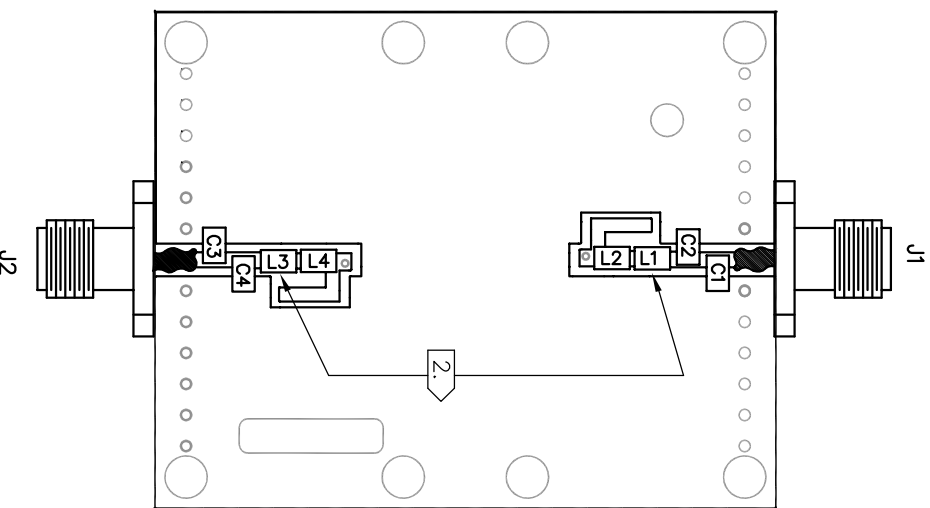
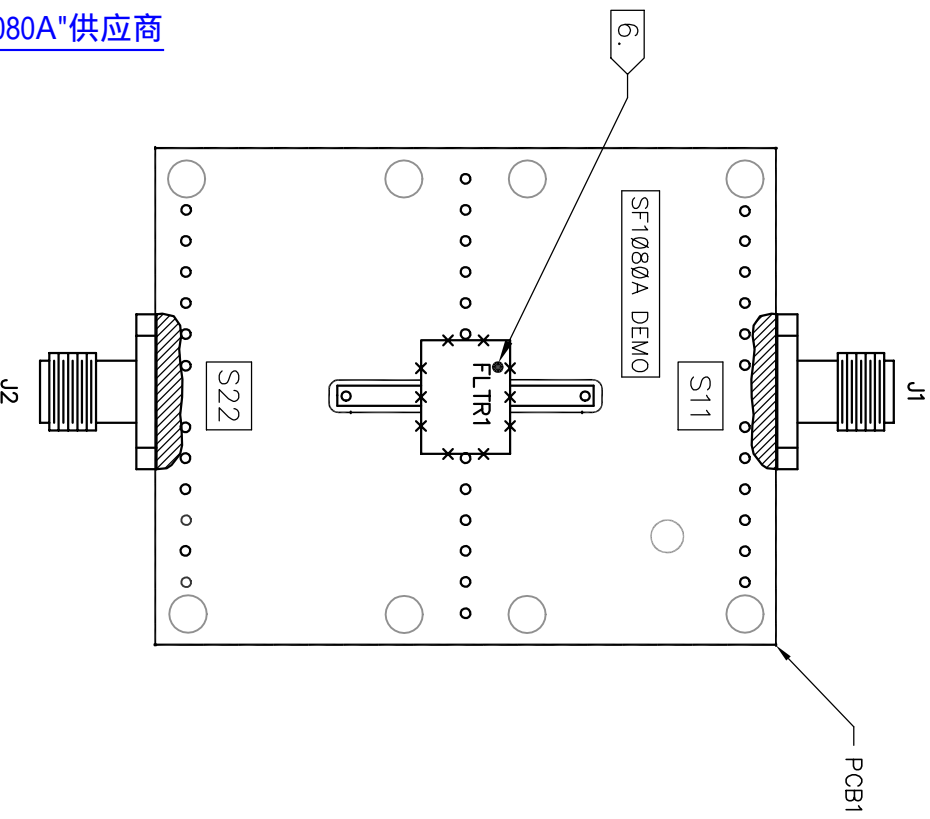

[查询"SF1080A"供应商](#)

RF Monolithics, Inc.
DALLAS, TEXAS 75244

ALL INFORMATION DISCLOSED BY THIS DOCUMENT IS
CONFIDENTIAL AND PROPRIETARY TO RF MONOLITHICS, INC.
ALL DESIGN, MANUFACTURE, USE, REPRODUCTION AND
SALES RIGHTS ARE RESERVED BY RF MONOLITHICS, INC.

SIZE
A

CODE IDENT
2U874

DWG. NO. **SF1080A-000**

REV
C1

SHEET
2

INSTRUCTIONS TO "FINE TUNE" THE DEMO BOARD.

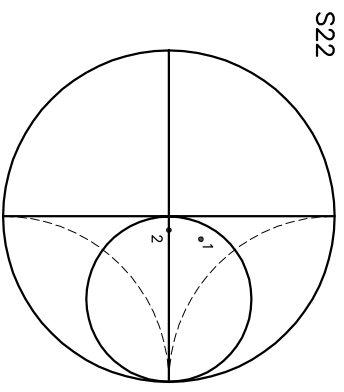

SMITH CHART

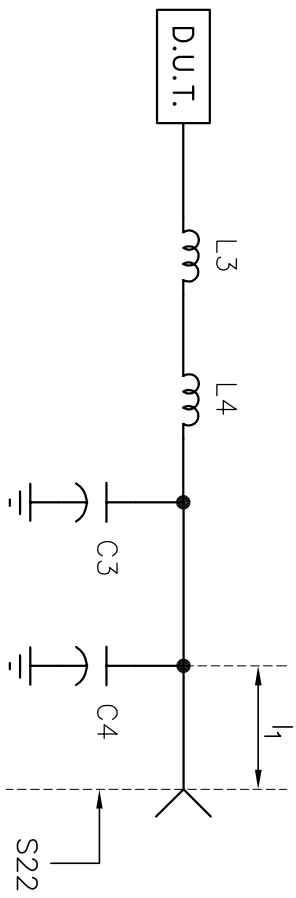

l_1 = Length of Transmission Line

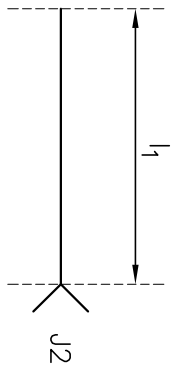

Model of Transmission Line(l_1)

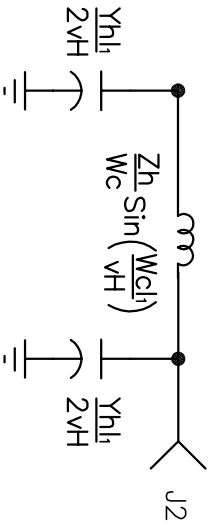

THESE INSTRUCTIONS ARE BASED ON MY OWN OBSERVATION WHEN TUNING THE DEMO BOARD. REFERRING TO THE SMITH CHART(S22); TO MOVE FROM LOCATION(1) TO LOCATION(2), A REDUCTION IN SERIES INDUCTANCE, CAUSED BY THE TRANSMISSION LINE IS NEEDED. TO REDUCE THIS INDUCTANCE, MOVE C4 CLOSER TO J2. THIS WILL REDUCE I WHICH IN TURN REDUCES THE INDUCTANCE MOVE TO LOCATION(2).

THE CAPACITORS CAN BE MOVED ALONG THE TRANSMISSION LINE TOWARDS THE D.U.T. OR CONNECTORS (J1 or J2) TO "FINE TUNE" THE D.U.T. TO 50Ω .

[查询"SF1080A"供应商](#)

RF Monolithics, Inc.
DALLAS, TEXAS 75244

ALL INFORMATION DISCLOSED BY THIS DOCUMENT IS CONFIDENTIAL AND PROPRIETARY TO RF MONOLITHICS, INC. ALL DESIGN, MANUFACTURE, USE, REPRODUCTION AND SALES RIGHTS ARE RESERVED BY RF MONOLITHICS, INC.

SIZE **A** CODE IDENT **2U874**

DWG. NO. **SF1080A-000**

REV **C1** SHEET **3**