

# High Voltage Solid State Relays

## General Information

### FEATURES

- 3750 Vrms or 5300 Vrms I/O isolation
- Current-limit protection built-in
- Linear ac/dc operation
- High-reliability monolithic receptor
- Extremely low leakage current (pA)
- High contact off-impedance (GΩ)
- Low power consumption (1 mW—12 mW)
- Very low switch offset (typically 0.1 μV)
- Logic compatible
- Clean, bounce-free switching
- Built-in 1 Form C break-before-make
- High surge capability
- Insensitive to dv/dt
- Surface mountable
- Compatible with UL1459 and FCC 68.302
- UL recognized
- CSA certified
- BABT certificate of recognition to BS6301

### BENEFITS

- Long life
- Maintenance free
- Current-limit SSRs can sustain repeated faults without damage
- Minimizes drive circuitry
- Noiseless
- Immune to shock
- Immune to environmental hazards such as salt, dirt, and humidity
- No arcing
- No mounting restrictions
- Preapproved for DAA applications
- High reliability
- Easily configured in series or in parallel for increased voltage or current

### DESCRIPTION

Siemens Solid State Relays (SSRs) are miniature, optically-coupled relays with high-voltage MOSFET outputs. The relays are capable of switching ac or dc loads from as little as nanovolts to hundreds of volts. Likewise, the relays can switch currents in the range of nanoamps to hundreds of milliamps. The MOSFET switches are ideal for small signal switching and are primarily suited for dc or audio frequency applications.

Siemens offers integrated current limiting on many of its relays. If load current through the relay exceeds the rated value, the relay clamps the current at a predefined value. If the excessive load current persists, the limiting circuit has a foldback feature to minimize relay power dissipation. The current-limit circuit has a multitude of uses. It can be used in telephony to clamp excessive currents emanating from lightning strikes and/or power-main crosses or in instrumentation and industrial application to squelch transients from reactive loads. The current-limit circuit also provides short-circuit protection in power-feed applications.

The SSRs feature a monolithic output die that minimizes wire bonds and permits easy integration of high-performance circuits such as current limiting in normally-open switches. The output die contains all the necessary circuitry to perform a relay function, including the photodiode receptor array, turn-on and turn-off control circuitry, and the MOSFET switches. The optically-coupled input is controlled by a highly efficient GaAIAs infrared LED.

Siemens SSRs are available in a 6- or 8-pin through-hole DIP or in gull-wing surface-mount packages. Some parts are also offered in 8- or 18-pin small-outline packages (SOPs). The SOPs are size and height compatible with PCMCIA Type 2 cards. A 0.4 mm distance through insulation spacing is also available on “H” suffix coded parts. Refer to the Parts Coding section for a more in-depth description of these parts.

### Typical Applications

- ac Switch
- Telephone
- Heater Control
- Light Control
- Switching Systems
- Voltmeters
- Test Equipment
- Modems
- Programmable Controllers
- FAX
- Data Acquisition Systems
- Security Equipment
- Electric Meters
- Ring Relay

Application	Flying Capacitor
Function	Flying Capacitor Switch
Equipment	Data Acquisition Systems
	Multiplexers
	Scanners

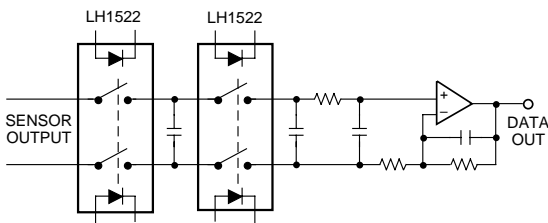

Application	Ring Generators
Function	Square Wave Generator
Equipment	PBX
	Central Office Equipment
	Ring Generator

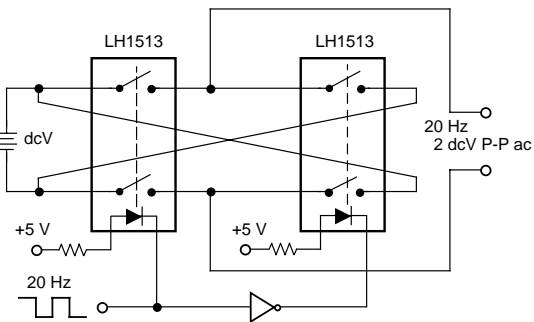

### Typical Applications (continued)

- Service Equipment
- E&M Signaling
- Multiplexers
- Scanners
- Motor Controls
- Output Modules
- Thermostats
- Answering Machines
- Battery Switch
- Board Testers
- Gas Pumps
- Appliances

Application	Telephone Line Interface/SLIC
Function	Ring Relay
	Break Switch
	Ground Start
	Test Access
	E&M Signalling
Equipment	Subscriber Line Interface Circuits
	PBX
	Switching Systems
	Test/Service Equipment

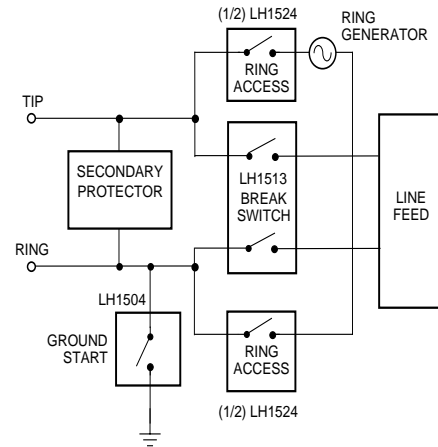

Application	Lamp, Light, Indicator Control
Function	ac Switch
Equipment	Programmable Controllers
	Thermostats
	Control Panels
	Industrial Controls

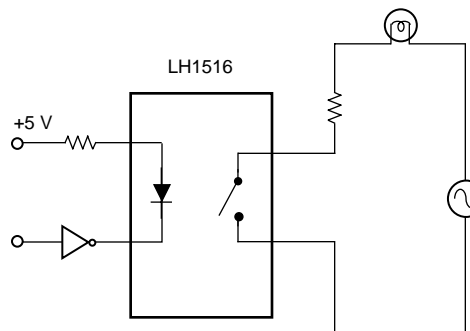

### 查询"LH1504"供应商

Application	Data Access Arrangement (DAA)
Function	Current-Limited Switchhook Control
Equipment	Modems
	Security Equipment
	Answering Machines
	Telephones
	FAX

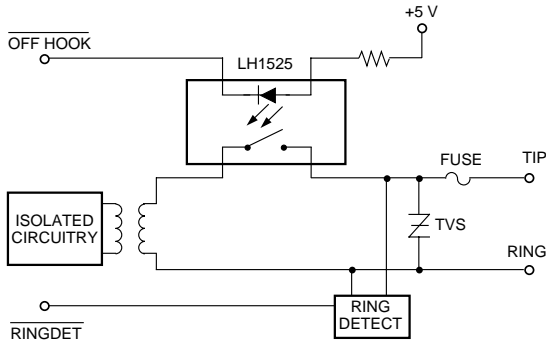

Application	Thermocouple Switching
Function	Thermocouple Matrix Control
Equipment	Scanners
	Data Acquisition Systems
	Programmable Controllers

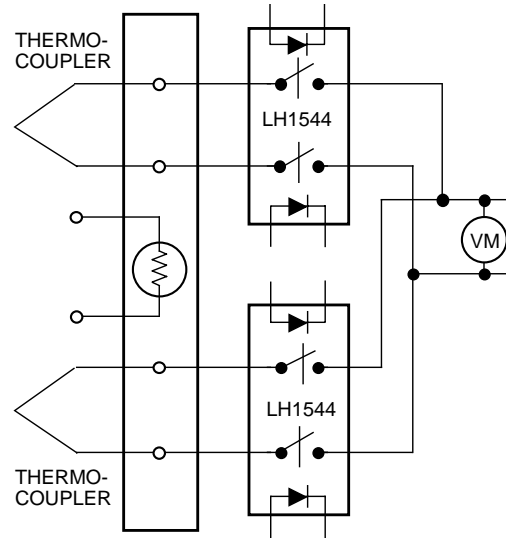

Application	Multiplexer
Function	Analog Signal Multiplexer
	Analog Input Module
Equipment	Instrumentation
	Voltmeters
	Test Equipment
	Board Testers
	Scanners
	Data Acquisition Systems

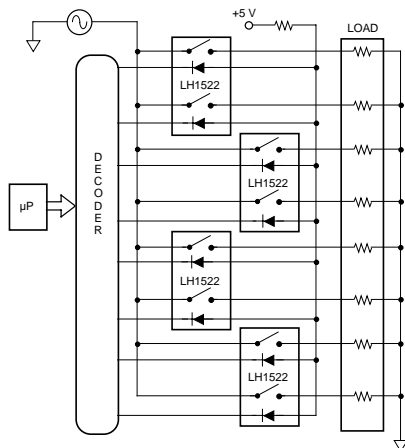

Application	Alarm Switch
Function	Glass Break Indicator
	Fire, Smoke Detector
Equipment	Security Systems
	Fire/Smoke Alarms

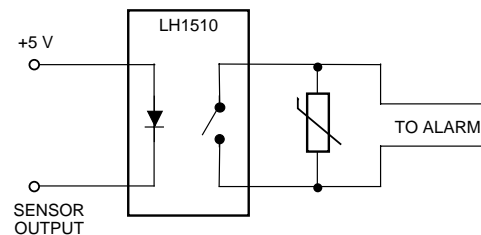

### 查询"LH1504"供应商

Application	Print Head Driver
Function	Current-Limited Drivers
	Piezoelectric Transducer
	High-Voltage Print Head
Equipment	Ink Jet Printers
	Display Drivers
	Thermal Printers

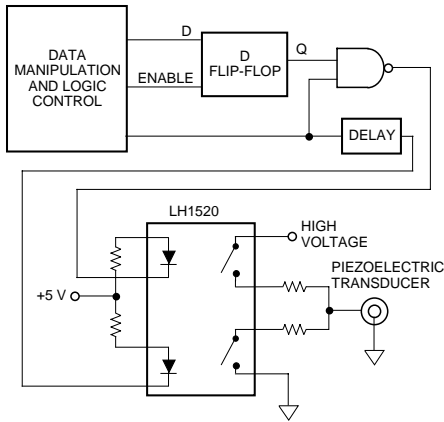

Application	Talk/Data Switch
Function	On/Off-hook Control
Equipment	Modems
	FAX

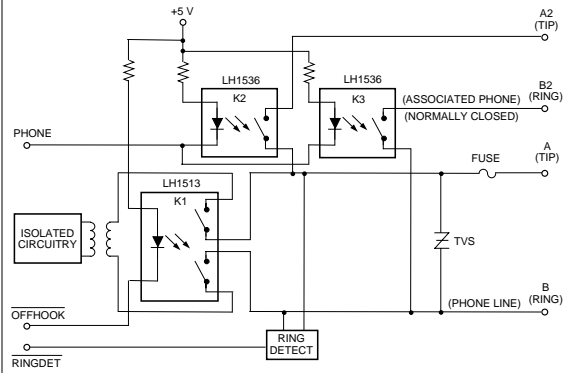

Application	Motor, Light, Heat, Solenoid Control
Function	Triac Predriver
Equipment	Industrial Controls
	Programmable Controllers
	Factory Automation Equipment
	Appliances

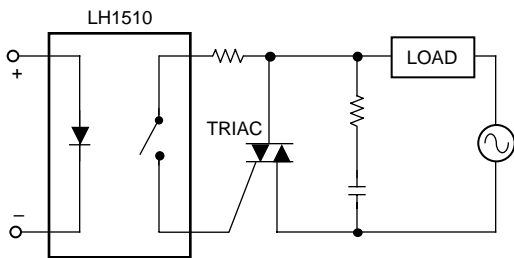

Application	Two-Line PSTN Interface
Function	On/Off-hook Control
Equipment	Telephone Equipment
	Test/Service Equipment

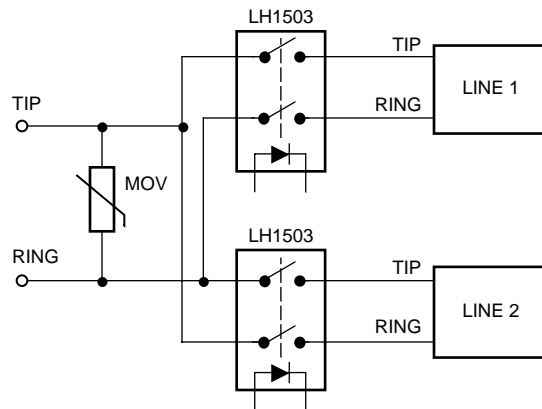

Wiring Diagrams  
[查询"LH1504"供应商](#)

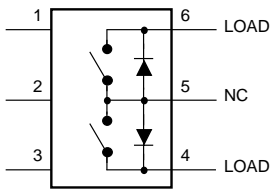
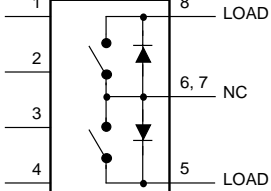
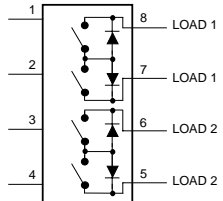
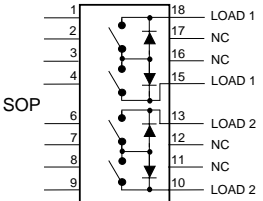
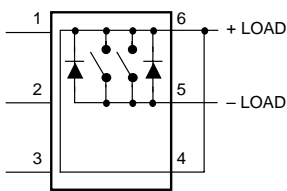
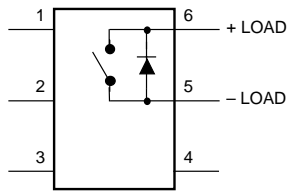
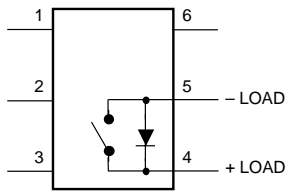
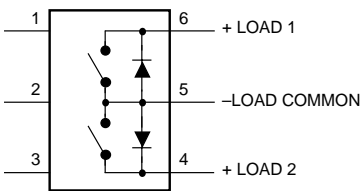
ac/dc OUTPUT CONFIGURATIONS	SINGLE LOAD	 
	TWO LOADS	 
dc OUTPUT CONFIGURATIONS	SINGLE LOAD — REDUCED RON — INCREASED LOAD CURRENT — REDUNDANCY	
	SINGLE LOAD	 
	TWO LOADS	

**Absolute Maximum Ratings  $T_A=25^\circ\text{C}$**

Stresses in excess of the Absolute Maximum Ratings can cause permanent damage to the device. These are absolute stress ratings only. Functional operation of the device is not implied at these or any other conditions in excess of those given in the operational sections of this document. Exposure to Absolute Maximum Ratings for extended periods of time can adversely affect reliability.

Parameter	Symbol	Test Conditions	LH1500	LH1504	LH1510	LH1516	Units
Ambient Operating Temperature range	$T_A$	—	-40 to +85				°C
Storage Temperature Range	$T_{stg}$	—	-40 to +150				
Pin Soldering Temperature	$T_S$	t=10 s max	260				
Input/Output Isolation Voltage*	$V_{ISO}$	—	3750				Vrms
LED Continuous Forward Current	$I_F$	—	50				mA
LED Reverse Voltage	$V_R$	$I_R \leq 10 \mu\text{A}$	8				V
dc or Peak ac Load Voltage	$V_L$	$I_L \leq 50 \mu\text{A}$	350	400	200	400	
Continuous dc Load Current Bidirectional Operation Unidirectional Operation	$I_L$	—	150 250	95 —	200 350	240 450	mA
Peak Load Current	$I_P$	t=100 ms (single shot)	†	†	†	†	mA
Output Power Dissipation (continuous)	$P_{DISS}$	—	600	550		600	mW

\* 5300 Vrms input/output isolation voltage available on some products. Consult factory.

† Refer to Current Limit Performance Application Note 58 for a discussion on relay operation during transient currents.

**Recommended Operating Conditions**

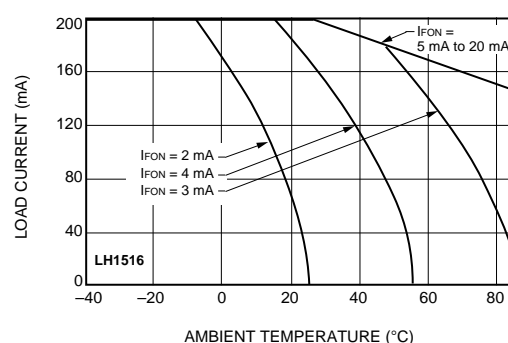
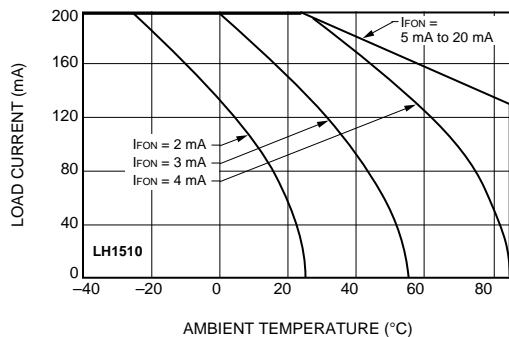
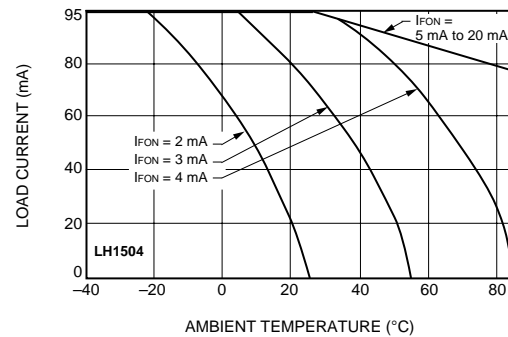
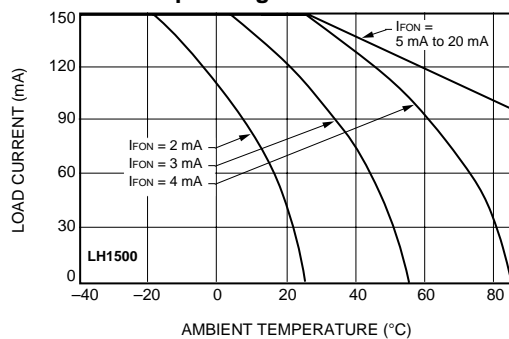

### Electrical Characteristics T<sub>A</sub>=25°C

Minimum and maximum values are testing requirements. Typical values are characteristics of the device and are the result of engineering evaluations. Typical values are for information purposes only and are not part of the testing requirements.

	Parameter	Symbol	Test Conditions	Values	LH1500	LH1504	LH1510	LH1516	Units
INPUT	LED Forward Current for Switch Turn-on	I <sub>Fon</sub>	I <sub>L</sub> =100 mA t=10 ms	Min	—	—	—	—	mA
				Typ	1.0	0.5	1.0	0.9	mA
				Max	2.0	2.0	2.0	2.0	mA
	LED Forward Current for Switch Turn-off	I <sub>Foff</sub>		Min	0.2	0.1	0.2	0.2	mA
				Typ	0.9	0.4	0.9	0.8	mA
				Max	—	—	—	—	mA
	LED Forward Voltage	V <sub>F</sub>	I <sub>F</sub> =10 mA	Min	1.15	1.15	1.15	1.15	V
				Typ	1.26	1.26	1.26	1.26	V
				Max	1.45	1.45	1.45	1.45	V
OUTPUT	ON-resistance ac/dc Pin 4 (±) to 6 (±) dc Pin 4, 6 (+) to 5 (±)	R <sub>ON</sub>	I <sub>F</sub> =5 mA I <sub>L</sub> =50 mA	Min	12	12*	6	5	Ω
				Typ	20	23*	10	7	Ω
				Max	25	34*	15	10	Ω
				Min	3.00	—	1.50	1.25	Ω
				Typ	5.00	—	2.50	2.00	Ω
				Max	6.25	—	3.75	2.50	Ω
	OFF-resistance	R <sub>OFF</sub>	I <sub>F</sub> =0 mA V <sub>L</sub> =±100 V	Min	0.5	0.5	0.5	0.5	GΩ
				Typ	5000	5000	5000	2500	GΩ
				Max	—	—	—	—	GΩ
	ON-state Voltage	—	I <sub>L</sub> =1 mA	Min	—	1.2	—	—	V
				Typ	—	1.4	—	—	V
				Max	—	1.8	—	—	V
Min				—	3.0	—	—	V	
Typ				—	3.6	—	—	V	
Max				—	5.0	—	—	V	
Current Limit ac/dc Pin 4 (±) to 6 (±) dc Pin 4, 6 (+) to 5 (±)	I <sub>LMT</sub>	I <sub>F</sub> =5 mA t=5 ms	Min	230	150	300	290	mA	
			Typ	270	210	360	400	mA	
			Max	370	270	450	550	mA	
			V <sub>L</sub>	±	6	11	5	5	V
			Min	—	—	600	—	mA	
			Typ	—	—	720	—	mA	
Off-state Leakage Current	—	I <sub>F</sub> =0 mA V <sub>L</sub> =±100 V	Min	—	—	—	—	nA	
			Typ	0.02	0.02	0.02	0.04	nA	
			Max	200	200	200	200	nA	
			Min	—	—	—	—	μA	
			Typ	—	—	—	—	μA	
			Max	1.0	1.0	1.0	1.0	μA	
Output Capacitance Pin 4 to 6	—	I <sub>F</sub> =0 mA V <sub>L</sub> =1 V	Min	—	—	—	—	pF	
			Typ	55	2.5	60	150	pF	
			Max	—	—	—	—	pF	
			Min	—	—	—	—	pF	
			Typ	10	2	15	30	pF	
			Max	—	—	—	—	pF	
Switch Offset	—	I <sub>F</sub> =5 mA	Min	—	—	—	—	μV	
			Typ	0.15	—	0.15	0.1	μV	
			Max	—	—	—	—	μV	
TRANSFER	Input/Output Capacitance	C <sub>ISO</sub>	V <sub>ISO</sub> =1 V	Min	—	—	—	—	pF
				Typ	0.8	0.8	0.8	0.8	pF
				Max	—	—	—	—	pF
	Turn-on Time	t <sub>on</sub>	I <sub>F</sub> =5 mA I <sub>L</sub> =50 mA	Min	—	—	—	—	ms
				Typ	1.2	1.6	1.0†	1.1†	ms
				Max	2.0	5.0	2.0†	3.0†	ms
	Turn-off Time	t <sub>off</sub>	I <sub>F</sub> =5 mA I <sub>L</sub> =50 mA	Min	—	—	—	—	ms
				Typ	0.5	2.0	0.7†	0.8†	ms
				Max	2.0	5.0	2.0†	3.0†	ms

\* R<sub>ON</sub>=V (50 mA) – V (20 mA)/30 mA, †I<sub>F</sub>=10 mA.

**Absolute Maximum Ratings**  $T_A=25^\circ\text{C}$

Stresses in excess of the Absolute Maximum Ratings can cause permanent damage to the device. These are absolute stress ratings only. Functional operation of the device is not implied at these or any other conditions in excess of those given in the operational sections of this document. Exposure to Absolute Maximum Ratings for extended periods of time can adversely affect reliability.

Parameter	Symbol	Test Conditions	LH1517	LH1518	LH1519	Units
Ambient Operating Temperature range	$T_A$	—	-40 to +85			°C
Storage Temperature Range	$T_{stg}$		-40 to +150			
Pin Soldering Temperature	$T_S$	t=10 s max	260			
Input/Output Isolation Voltage*	$V_{ISO}$	—	3750			Vrms
LED Continuous Forward Current	$I_F$		50			mA
LED Reverse Voltage	$V_R$	$I_R \leq 10 \mu\text{A}$	8			V
dc or Peak ac Load Voltage	$V_L$	$I_L \leq 50 \mu\text{A}$	150	250		
Continuous dc Load Current Bidirectional Operation Unidirectional Operation	$I_L$	—	400 800	155 300	240 450	mA
Peak Load Current	$I_P$	t=100 ms (single shot)	1200	†	†	
Output Power Dissipation (continuous)	$P_{DISS}$	—	600	550		mW

\* 5300 Vrms input/output isolation voltage available on some products. Consult factory.

† Refer to Current-Limit Performance Application Note for a discussion on relay operation during transient currents.

**Recommended Operating Conditions**

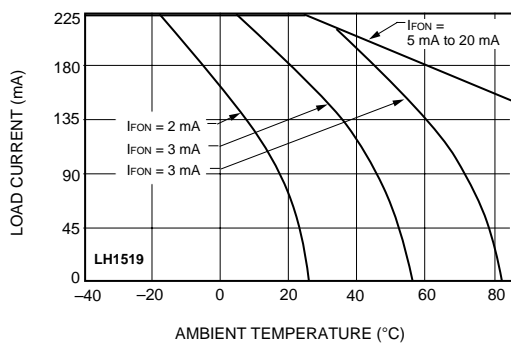
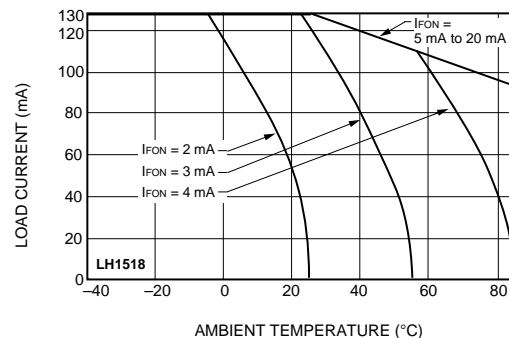
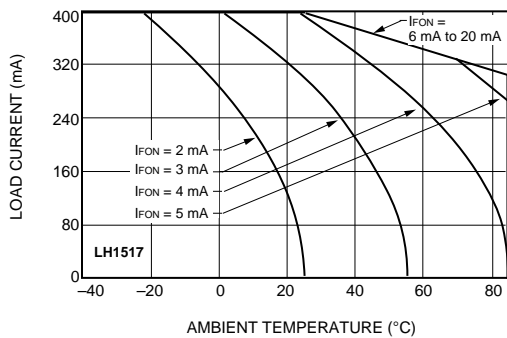



**Electrical Characteristics  $T_A=25^\circ\text{C}$**

Minimum and maximum values are testing requirements.  
Typical values are characteristics of the device and are the

result of engineering evaluations. Typical values are for information purposes only and are not part of the testing requirements.

	Parameter	Symbol	Test Conditions	Values	LH1517	LH1518	LH1519	Units	
INPUT	LED Forward Current for Switch Turn-on	$I_{Fon}$	$I_L=100\text{ mA}$ $t=10\text{ ms}$	Min	—	—	—	mA	
				Typ	0.9	0.8	0.9	mA	
				Max	2.0	2.0	2.0	mA	
	LED Forward Current for Switch Turn-off	$I_{Foff}$		Min	0.2	0.2	0.2	mA	
				Typ	0.8	0.7	0.8	mA	
				Max	—	—	—	mA	
	LED Forward Voltage	$V_F$	$I_F=10\text{ mA}$	$V_L$	$\pm$	100	200	200	V
				Min	1.15	1.15	1.15	V	
				Typ	1.26	1.26	1.26	V	
OUTPUT	ON-resistance ac/dc Pin 4 ( $\pm$ ) to 6 ( $\pm$ ) dc Pin 4, 6 (+) to 5 ( $\pm$ )	$R_{ON}$	$I_F=5\text{ mA}$ $I_L=50\text{ mA}$	Min	1	10	3	$\Omega$	
				Typ	2	15	6	$\Omega$	
				Max	3	20	10	$\Omega$	
			$I_F=5\text{ mA}$ $I_L=100\text{ mA}$	Min	0.25	2.50	0.75	$\Omega$	
				Typ	0.50	3.75	1.50	$\Omega$	
				Max	0.85	5.00	2.50	$\Omega$	
	OFF-resistance	$R_{OFF}$	$I_F=0\text{ mA}$ $V_L=\pm 100\text{ V}$	Min	0.5	0.5	0.5	G $\Omega$	
				Typ	2500	5000	2500	G $\Omega$	
				Max	—	—	—	G $\Omega$	
	ON-state Voltage	—	$I_L=1\text{ mA}$	Min	—	—	—	V	
				Typ	—	—	—	V	
				Max	—	—	—	V	
				$I_L=90\text{ mA}$ $t=10\text{ ms}$	Min	—	—	—	V
					Typ	—	—	—	V
					Max	—	—	—	V
	Current Limit ac/dc Pin 4 ( $\pm$ ) to 6 ( $\pm$ ) dc Pin 4, 6 (+) to 5 ( $\pm$ )	$I_{LMT}$	$I_F=5\text{ mA}$ $t=5\text{ ms}$	Min	—	170	330	mA	
				Typ	—	200	450	mA	
				Max	—	280	550	mA	
			$V_L$	$\pm$	—	6	4	V	
				Min	—	—	—	mA	
				Typ	—	—	—	mA	
	Off-state Leakage Current	—	$I_F=0\text{ mA}$ $V_L=\pm 100\text{ V}$	Min	—	—	—	nA	
				Typ	0.04	0.02	0.04	nA	
				Max	200	200	200	nA	
	Output Capacitance Pin 4 to 6	—	$I_F=0\text{ mA}$ $V_L=1\text{ V}$	Min	—	—	—	pF	
				Typ	185	55	100	pF	
				Max	—	—	—	pF	
$I_F=0\text{ mA}$ $V_L=50\text{ V}$			Min	—	—	—	pF		
			Typ	45	10	20	pF		
			Max	—	—	—	pF		
Switch Offset	—	$I_F=5\text{ mA}$	Min	—	—	—	V		
			Typ	0.1	0.15	0.1	V		
			Max	—	—	—	V		
TRANSFER	Input/Output Capacitance	$C_{ISO}$	$V_{ISO}=1\text{ V}$	Min	—	—	—	pF	
				Typ	0.8	0.8	0.8	pF	
				Max	—	—	—	pF	
	Turn-on Time	$t_{on}$	$I_F=5\text{ mA}$ $I_L=50\text{ mA}$	Min	—	—	—	ms	
				Typ	1.7 <sup>†</sup>	1.4	2.0	ms	
				Max	3.0 <sup>†</sup>	3.0	3.0	ms	
	Turn-off Time	$t_{off}$	$I_F=5\text{ mA}$ $I_L=50\text{ mA}$	Min	—	—	—	ms	
				Typ	1.3 <sup>†</sup>	0.7	0.9	ms	
				Max	3.0 <sup>†</sup>	3.0	3.0	ms	

\*  $I_F=1.5\text{ mA}$

†  $I_F=10\text{ mA}$

‡  $I_L=25\text{ mA}$

**Absolute Maximum Ratings**  $T_A=25^\circ\text{C}$

Stresses in excess of the Absolute Maximum Ratings can cause permanent damage to the device. These are absolute stress ratings only. Functional operation of the device is not

implied at these or any other conditions in excess of those given in the operational sections of this document. Exposure to Absolute Maximum Ratings for extended periods of time can adversely affect reliability.

Parameter	Symbol	Test Conditions	LH1530	LH1535/ LH1540	LH1541	LH1550	Units
Ambient Operating Temperature Range	$T_A$	—	-40 to +85	-40 to +85	-40 to +85	-40 to + 85	$^\circ\text{C}$
Storage Temperature Range	$T_{\text{stg}}$	—	-40 to +150	-40 to +150	-40 to +150	-40 to +150	$^\circ\text{C}$
Pin Soldering Temperature	$T_S$	t=10 s max	260	260	260	260	$^\circ\text{C}$
Input/Output Isolation Voltage*	$V_{\text{ISO}}$	—	3750	3750	3750	3750	Vrms
LED Continuous Forward Current	$I_F$	—	50	50	50	50	mA
LED Reverse Voltage	$V_R$	$I_R \leq 10 \mu\text{A}$	8	8	8	5	V
dc or Peak ac Load Voltage	$V_L$	$I_L \leq 50 \mu\text{A}$	350	400/350	200	350	V
Continuous dc Load Current Bidirectional Operation Unidirectional Operation	$I_L$	—	150 250	120 250	55 —	100 —	mA mA
Peak Load Current	$I_P$	t=100 ms (single shot)	400	†	100	†	mA
Output Power Dissipation (continuous)	$P_{\text{DISS}}$	—	550	550	550	550	mW

\* 5300 Vrms input/output isolation voltage available on some products. Consult factory.

† Refer to Current-Limit Performance Application Note for a discussion on relay operation during transient currents

**Recommended Operating Conditions**

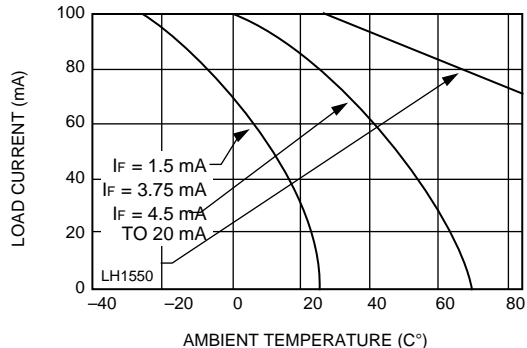
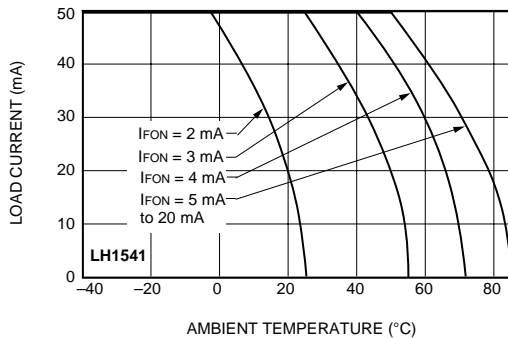
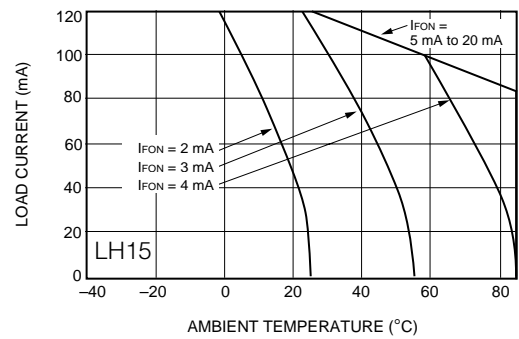
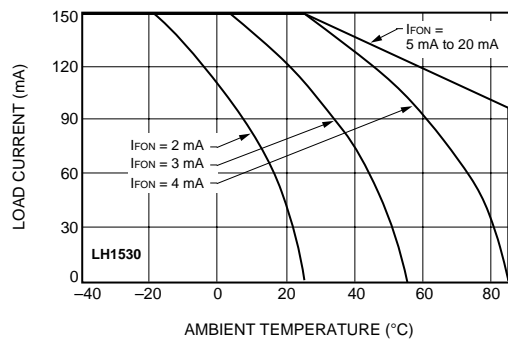

**Electrical Characteristics** T<sub>A</sub>=25°C

Minimum and maximum values are testing requirements. Typical values are characteristics of the device and are the

result of engineering evaluations. Typical values are for information purposes only and are not part of the testing requirements.

	Parameter	Symbol	Test Conditions	Values	LH1530	LH1535/ LH1540	LH1541	LH1550	Units
INPUT	LED Forward Current for Switch Turn-on	I <sub>Fon</sub>	I <sub>L</sub> =100 mA t=10 ms	Min	—	—	—	—	mA
				Typ	1.0	1.0	0.6	1.2	mA
				Max	2.0	2.0	2.0	2.5	mA
	LED Forward Current for Switch Turn-off	I <sub>Foff</sub>	V <sub>L</sub>	Min	0.2	0.2	0.1	0.01	mA
				Typ	0.9	0.9	0.5	1.100	mA
				Max	—	—	—	—	mA
	LED Forward Voltage	V <sub>F</sub>	I <sub>F</sub> =10 mA	±	300	350/300	150	300	V
				Min	1.15	1.15	1.10*	1.10*	V
				Typ	1.26	1.26	1.19*	1.19*	V
OUTPUT	ON-resistance ac/dc Pin 4 (±) to 6 (±) dc Pin 4, 6 (+) to 5 (±)	R <sub>ON</sub>	I <sub>F</sub> =5 mA I <sub>L</sub> =50 mA	Min	12	12	70	25‡	Ω
				Typ	18	20	110	37‡	Ω
				Max	25	25	160	50‡	Ω
	OFF-resistance	R <sub>OFF</sub>	I <sub>F</sub> =5 mA I <sub>L</sub> =100 mA	Min	3.00	3.00	—	—	Ω
				Typ	5.00	5.00	—	—	Ω
				Max	6.25	6.25	—	—	Ω
	ON-state Voltage	—	I <sub>L</sub> =1 mA	Min	0.5	0.5	0.5	0.5	GΩ
				Typ	5000	5000	10000	5000	GΩ
				Max	—	—	—	—	GΩ
ON-state Voltage	—	I <sub>L</sub> =90 mA t=10 ms	Min	—	—	—	—	V	
			Typ	—	—	—	—	V	
			Max	—	—	—	—	V	
Current Limit ac/dc Pin 4 (±) to 6 (±) dc Pin 4, 6 (+) to 5 (±)	I <sub>LMT</sub>	I <sub>F</sub> =5 mA t=5 ms	Min	—	170	—	150	mA	
			Typ	—	210	—	200	mA	
			Max	—	250	—	270	mA	
Off-state Leakage Current	—	I <sub>F</sub> =0 mA V <sub>L</sub> =±100 V	±	—	6	—	13	V	
			Min	—	—	—	—	mA	
			Typ	—	—	—	—	mA	
Off-state Leakage Current	—	I <sub>F</sub> =0 mA	Min	—	—	—	—	nA	
			Typ	0.1	0.32	0.4	0.3	nA	
			Max	200	200	200	200	nA	
Output Capacitance Pin 4 to 6	—	I <sub>F</sub> =0 mA V <sub>L</sub> =1 V	Min	—	—	—	—	μA	
			Typ	—	—	—	—	μA	
			Max	1.0	1.0	1.0	1.0	μA	
Switch Offset	—	I <sub>F</sub> =5 mA	±	350	400/350	200	350	V	
			Min	—	—	—	—	pF	
			Typ	55	55	4.8	40	pF	
Switch Offset	—	I <sub>F</sub> =0 mA V <sub>L</sub> =50 V	Min	—	—	—	—	pF	
			Typ	10	10	3.6	8	pF	
			Max	—	—	—	—	pF	
TRANSFER	Input/Output Capacitance	C <sub>ISO</sub>	V <sub>ISO</sub> =1 V	Min	—	—	—	—	V
				Typ	0.15	0.15	0.15	0.15	V
				Max	—	—	—	—	V
	Turn-on Time	t <sub>on</sub>	I <sub>F</sub> =5 mA I <sub>L</sub> =50 mA	Min	—	—	—	—	ms
				Typ	0.5†	1.2	0.12	1.4	ms
				Max	1.0†	2.0	0.25	3.0	ms
	Turn-off Time	t <sub>off</sub>	I <sub>F</sub> =5 mA I <sub>L</sub> =50 mA	Min	—	—	—	—	ms
				Typ	0.5†	0.5	0.03	0.5	ms
				Max	1†	2.0	0.25	3.0	ms

\* I<sub>F</sub>=5 mA.  
† I<sub>F</sub>=10 mA.  
‡ I<sub>L</sub>=100 mA, t=10 ms

**A. LED Voltage vs. Temperature**

[查询 LH1504 供应商](#)

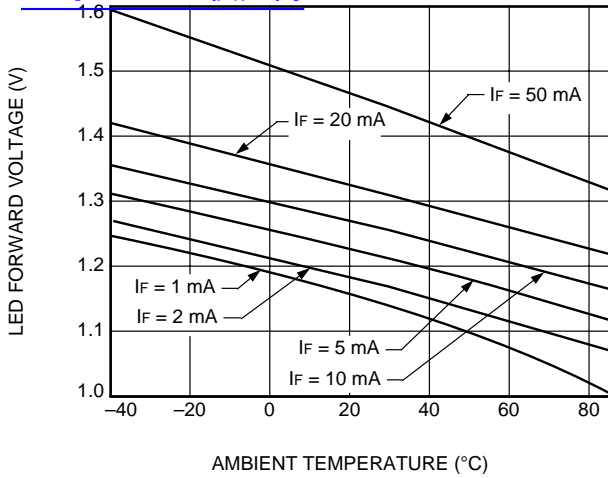

**B. LED Dropout Voltage vs. Temperature**

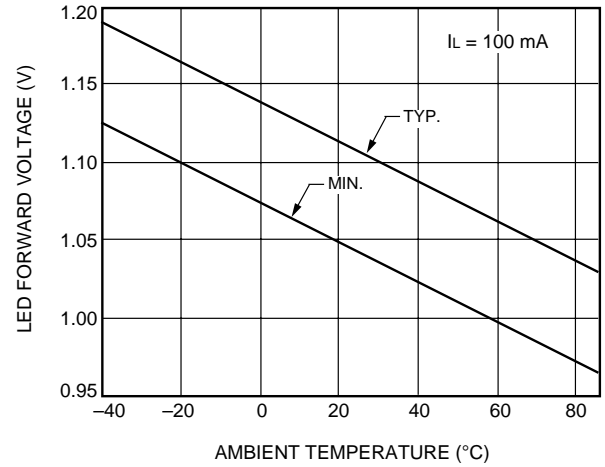

**C. LED Current for Switch Turn-On vs. Temperature**

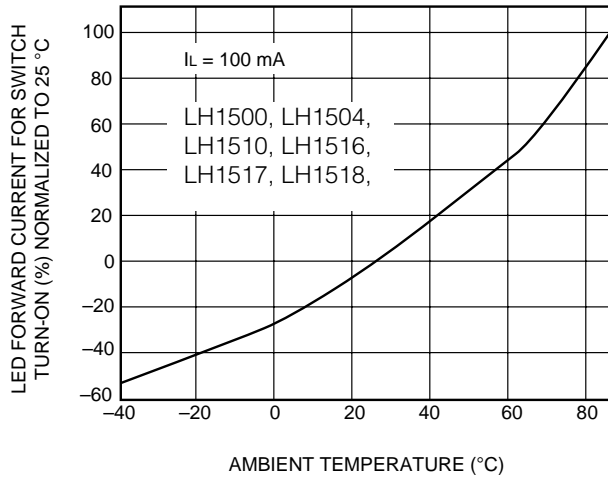

**D. LED Current for Switch Turn-On vs. Temperature (LH1541)**

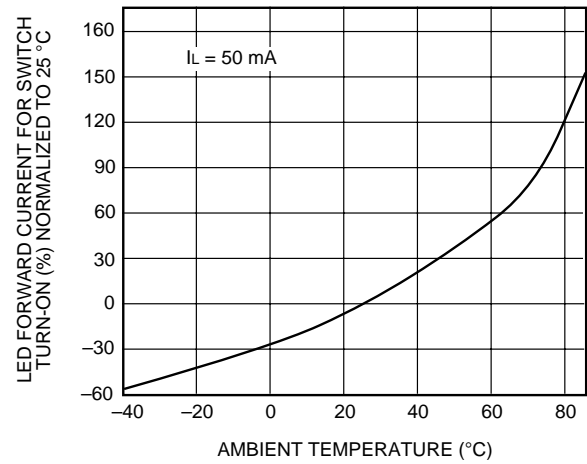

**E. Current Limit vs. Temperature**

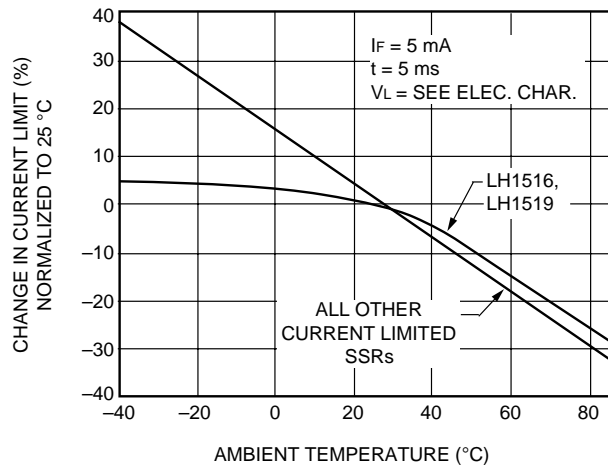

**F. ON-Resistance vs. Temperature**

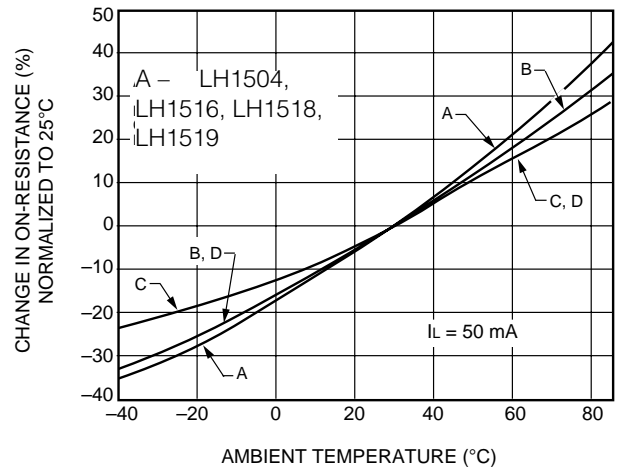

**A. Variation in ON-Resistance vs. LED Current**

[查询“LH1504”供应商](#)

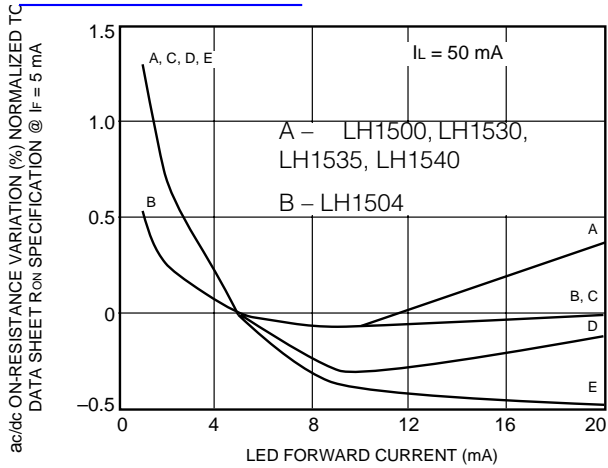

**B. Variation in ON-Resistance vs. LED Current (LH1525)**

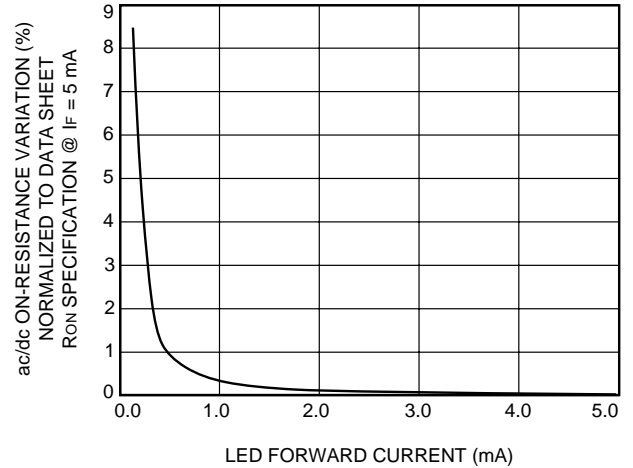

**C. Switch Capacitance vs. Applied Voltage**

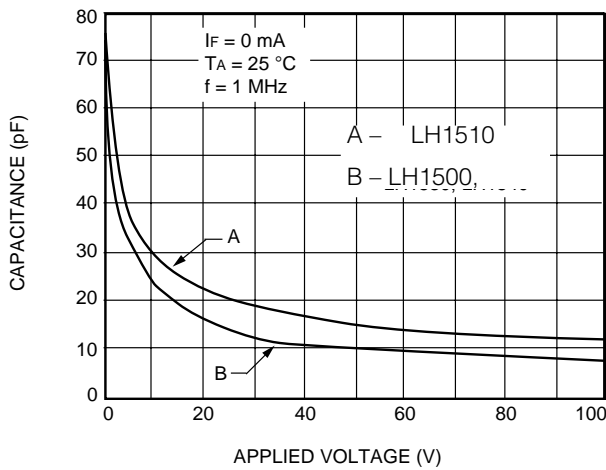

**D. Switch Capacitance vs. Applied Voltage**

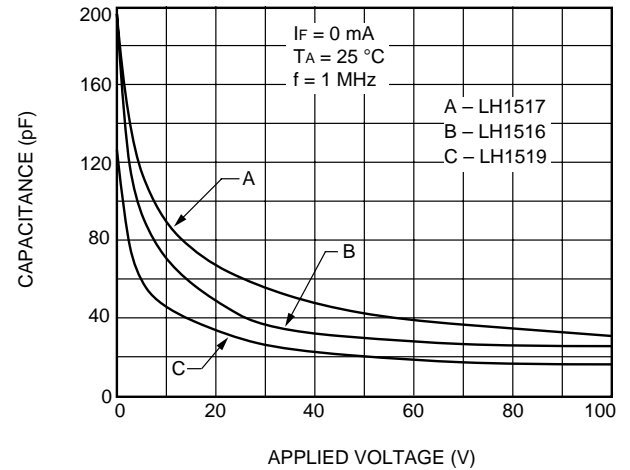

**E. Switch Capacitance vs. Applied Voltage (LH1525)**

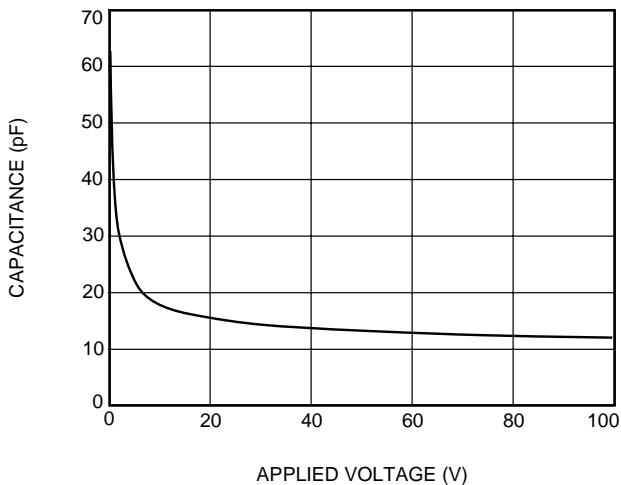

**F. Switch Capacitance vs. Applied Voltage (LH1541)**

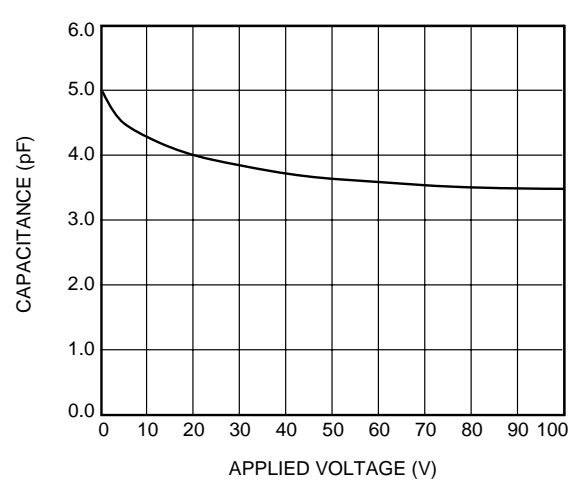

**A. Insertion Loss vs. Frequency**

[查询“LH1504”供应商](#)

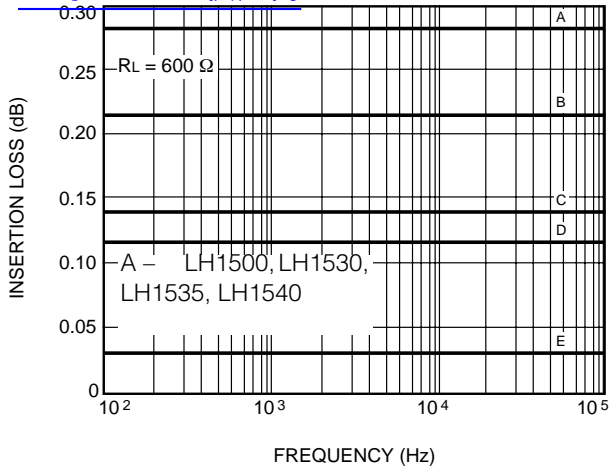

**B. Insertion Loss vs. Frequency (LH1525)**

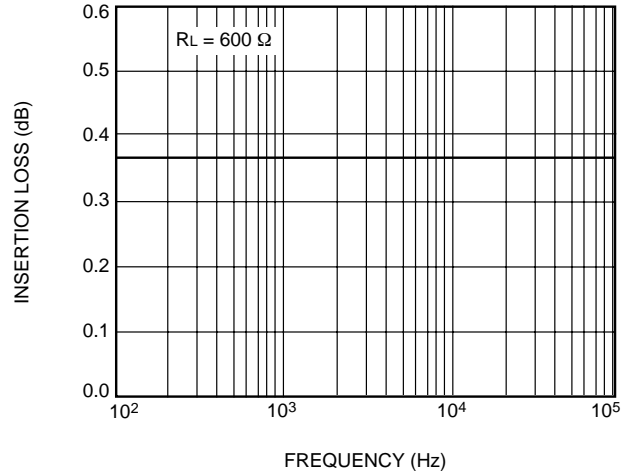

**C. Insertion Loss vs. Frequency (LH1541)**

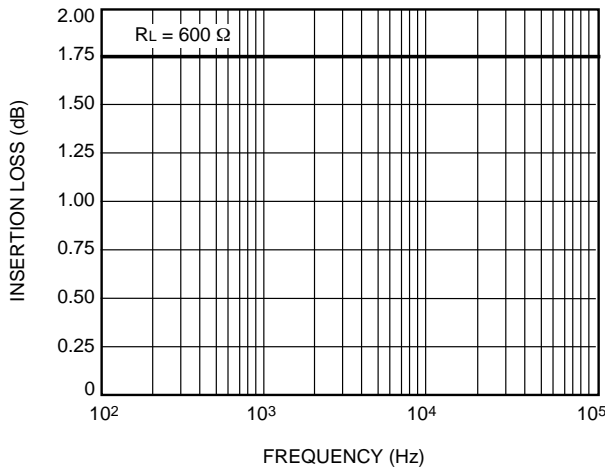

**D. Output Isolation**

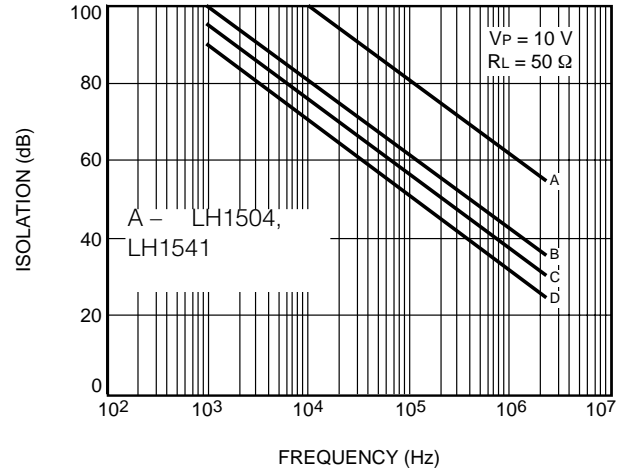

**E. Leakage Current vs. Applied Voltage**

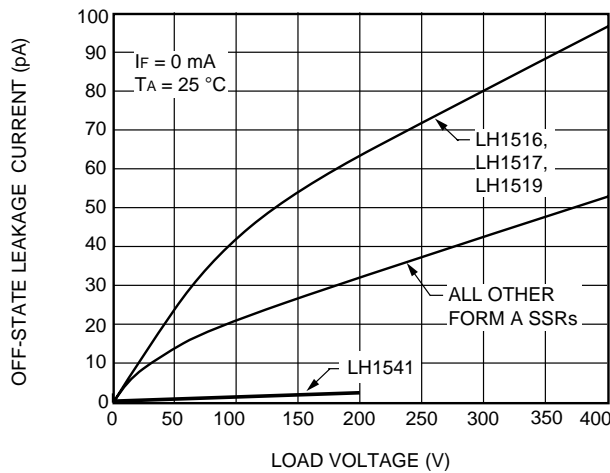

**F. Leakage Current vs. Applied Voltage at Elevated Temperatures**

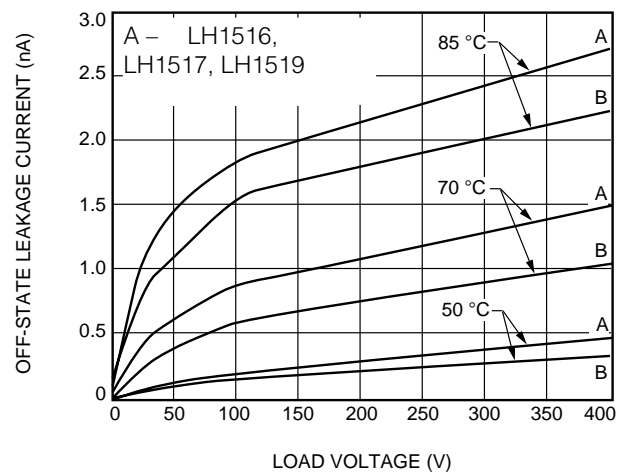

**A. Leakage Current vs. Applied Voltage at Elevated Temperatures (LH1525)**

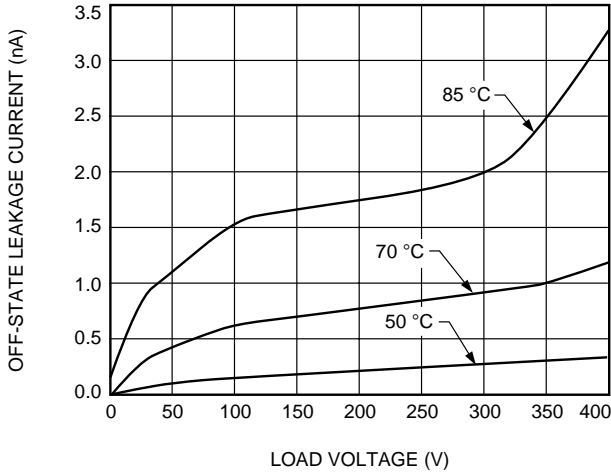

**B. Leakage Current vs. Applied Voltage at Elevated Temperatures (LH1541)**

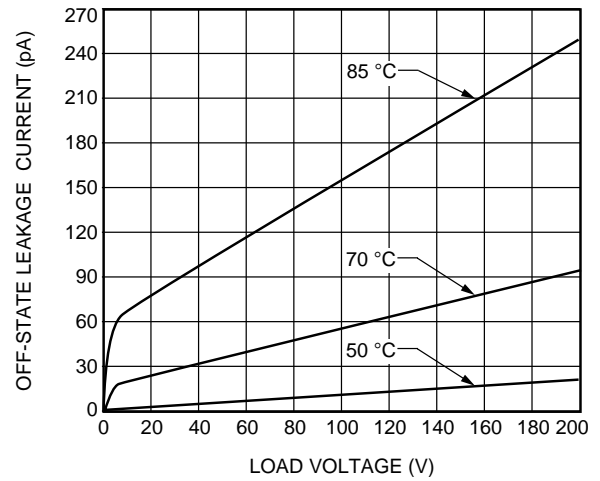

**C. Switch Breakdown Voltage vs. Temperature**

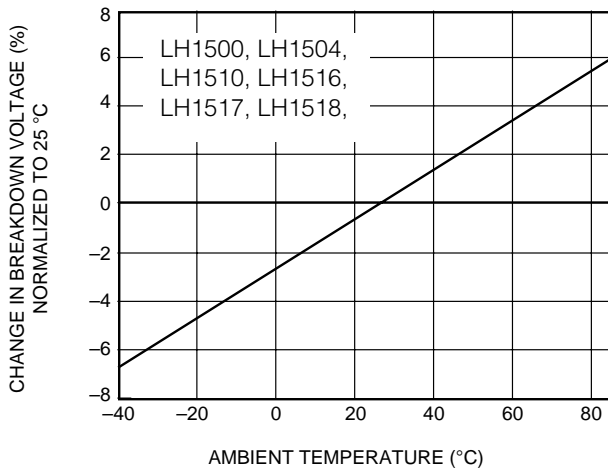

**D. Switch Breakdown Voltage vs. Temperature (LH1541)**

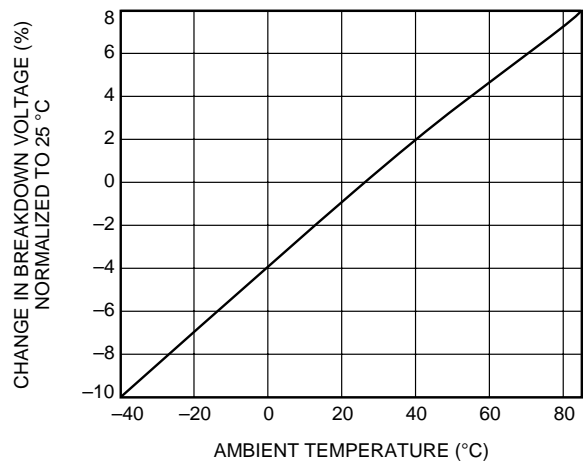

**E. Switch Offset Voltage vs. Temperature**

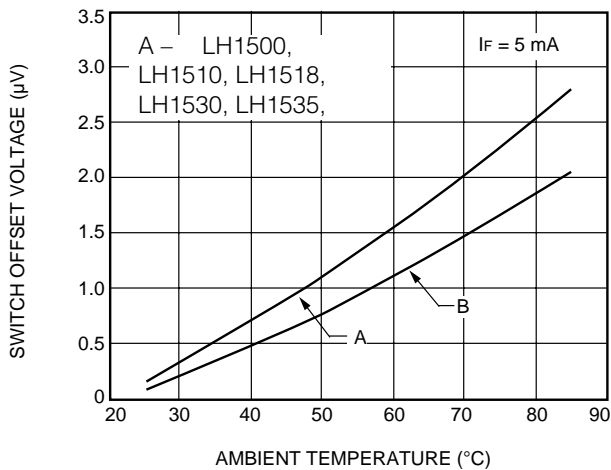

**F. Switch Offset Voltage vs. Temperature (LH1525)**

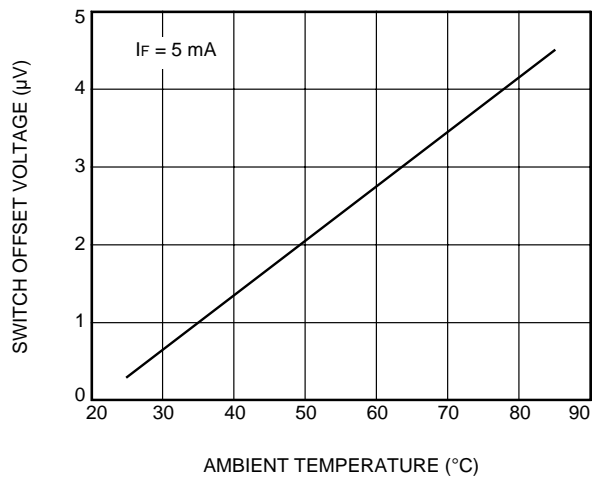

**A. Switch Offset Voltage vs. LED Current**

[查询"LH1504"供应商](#)

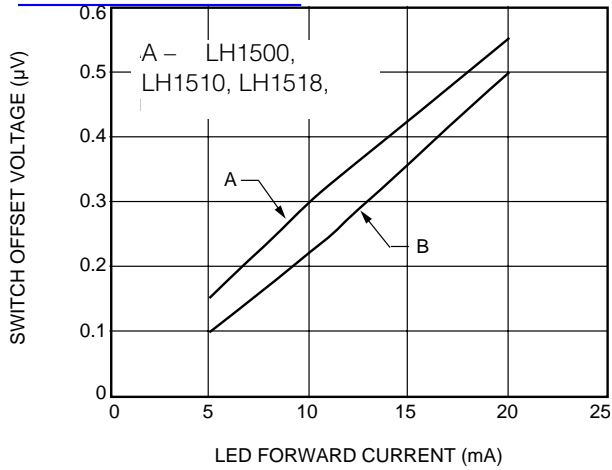

**B. Switch Offset Voltage vs. LED Current (LH1525)**

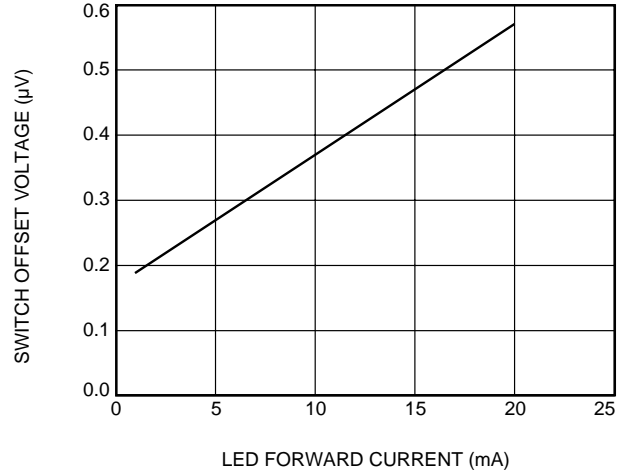

**C. Switch Offset Voltage vs. LED Current (LH1541)**

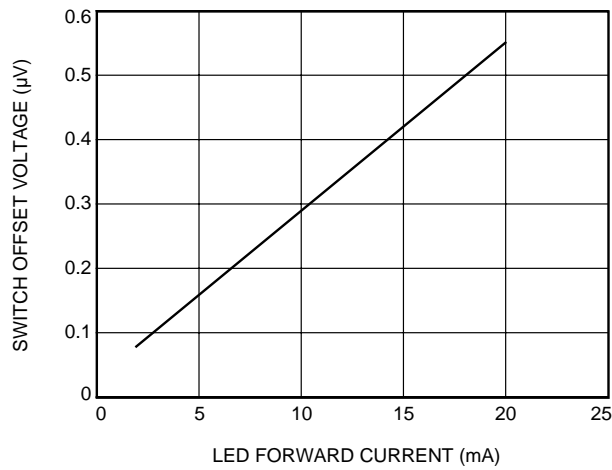

**D. Turn-On Time vs. Temperature**

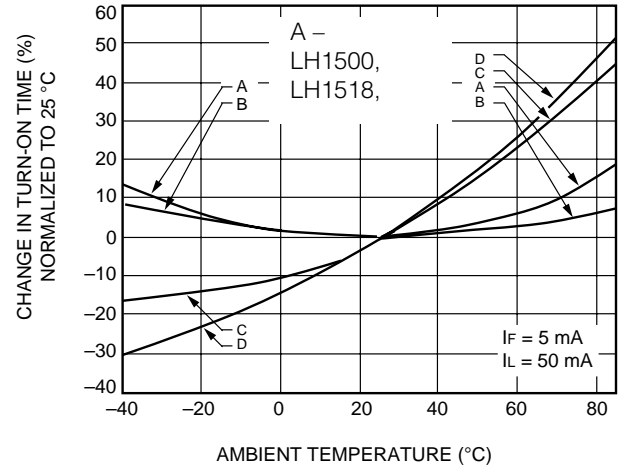

**E. Turn-On Time vs. Temperature (LH1541)**

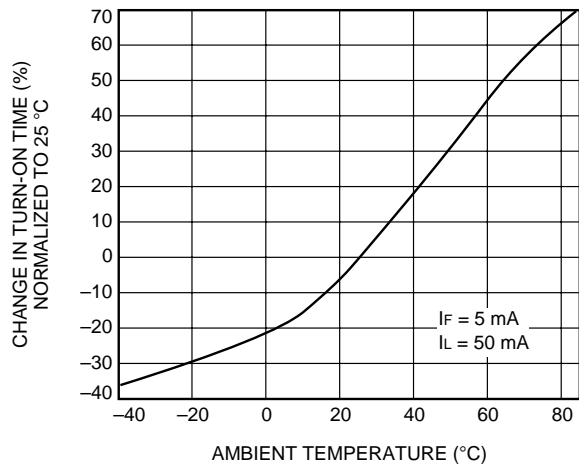

**F. Turn-Off Time vs. Temperature**

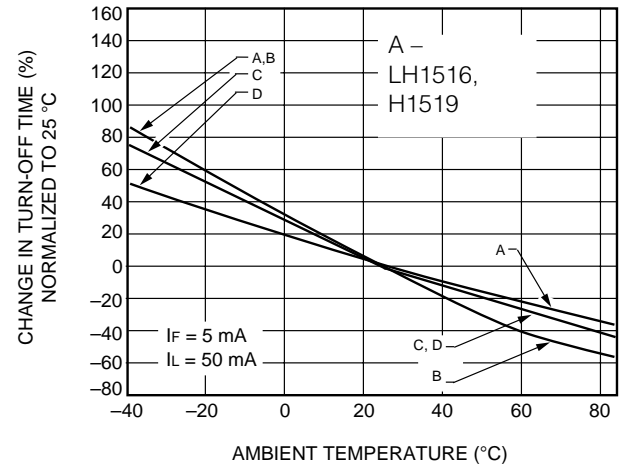



**A. Turn-Off Time vs. Temperature (LH1525)**

查询"LH1504"供应商

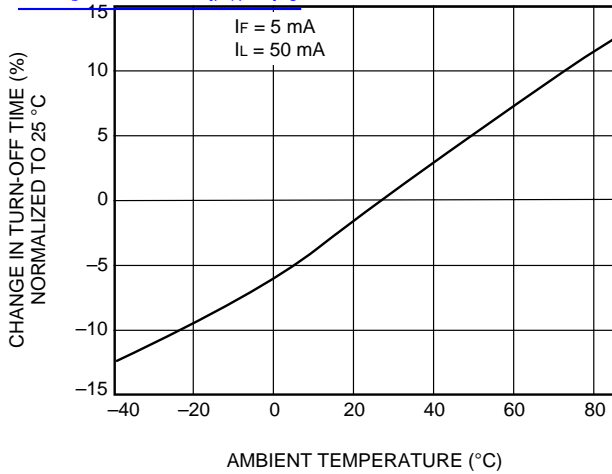

**B. Turn-Off Time vs. Temperature (LH1541)**

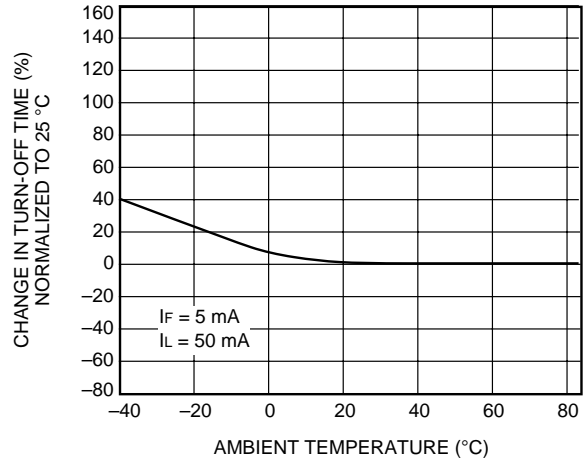

**C. Turn-On Time vs. LED Current (LH1500, LH1518, LH1540)**

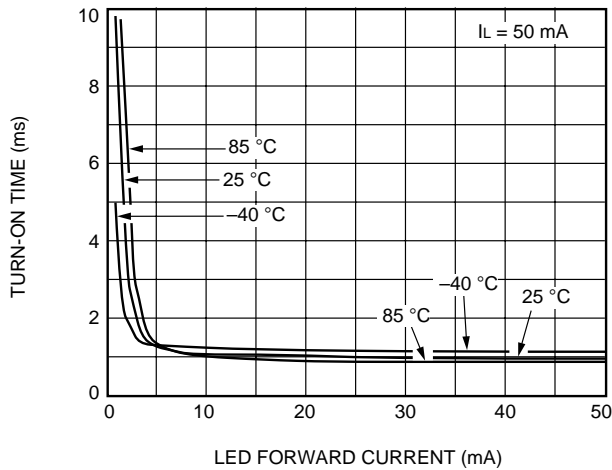

**D. Turn-On Time vs. LED Current (LH1504)**

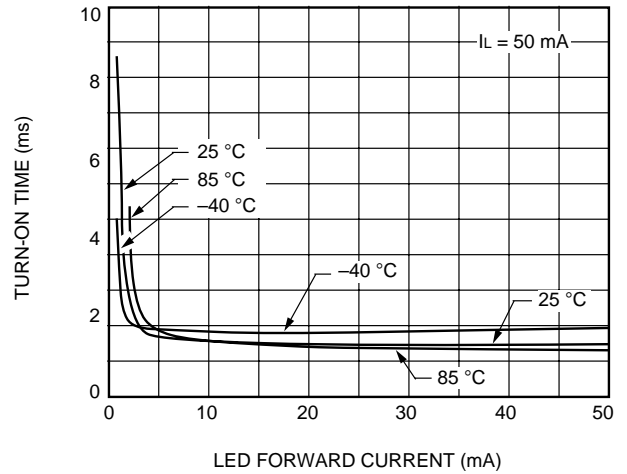

**E. Turn-On Time vs. LED Current (LH1510)**

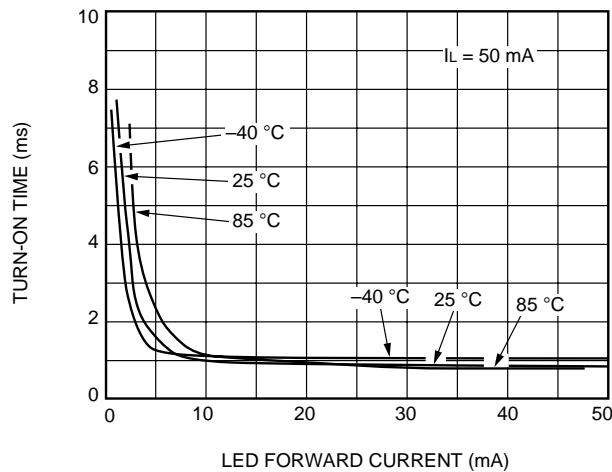

**F. Turn-On Time vs. LED Current (LH1516, LH1519)**

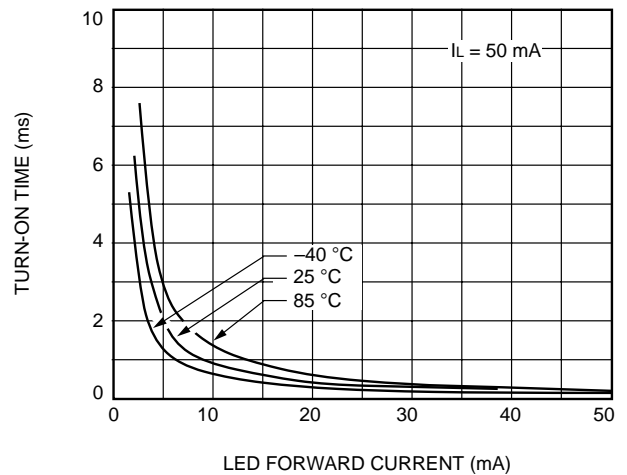

**A. Turn-On Time vs. LED Current (LH1517)**

[查询"LH1504"供应商](#)

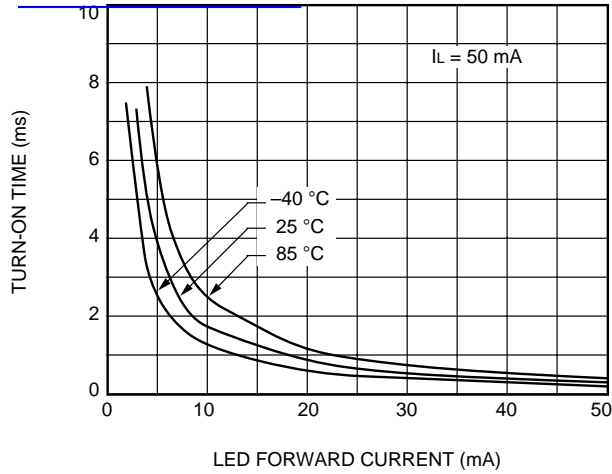

**B. Turn-On Time vs. LED Current (LH1525)**

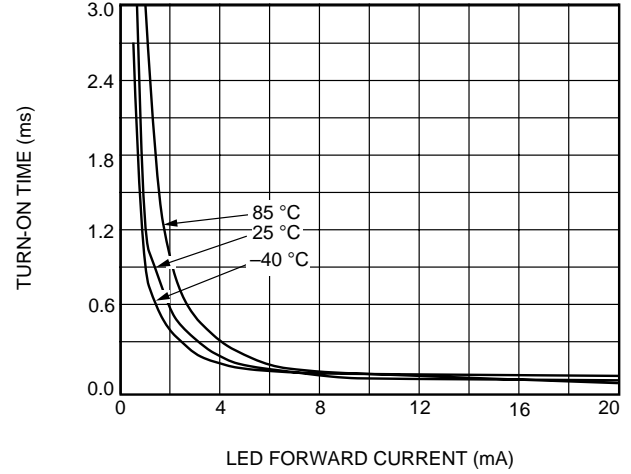

**C. Turn-On Time vs. LED Current (LH1530)**

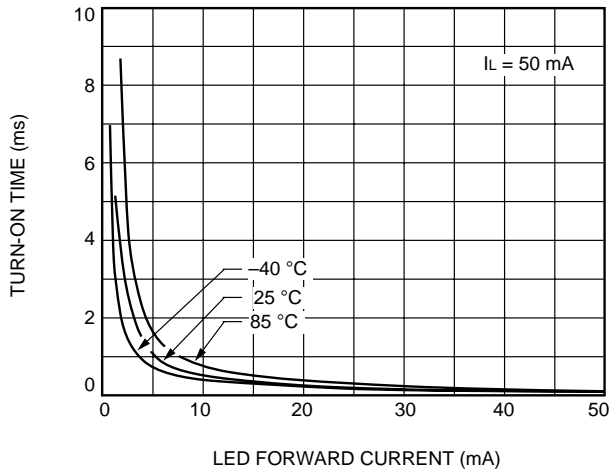

**D. Turn-On Time vs. LED Current (LH1541)**

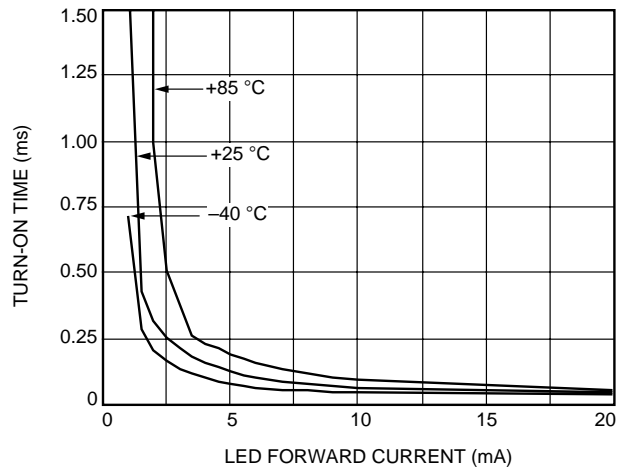

**E. Turn-Off Time vs. LED Current (LH1500, LH1530, LH1540)**

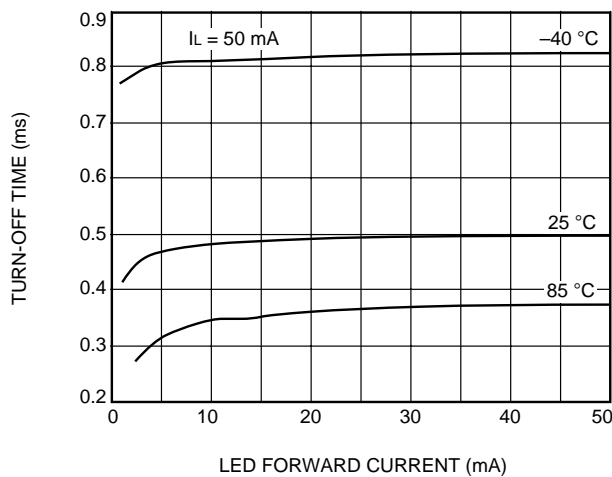

**F. Turn-Off Time vs. LED Current (LH1504)**

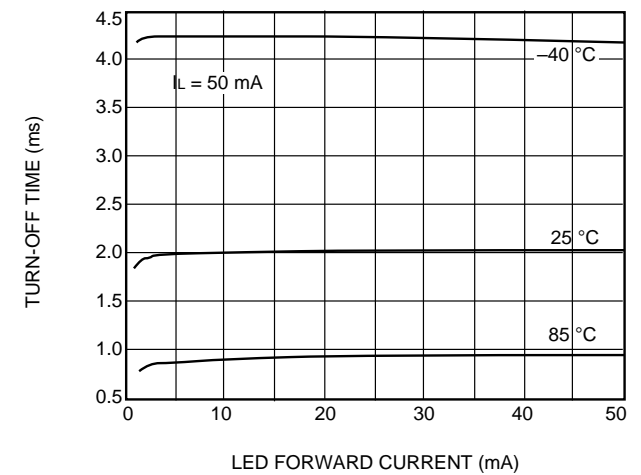

**A. Turn-Off Time vs. LED Current (LH1510, LH1518)**

[查询"LH1504"供应商](#)

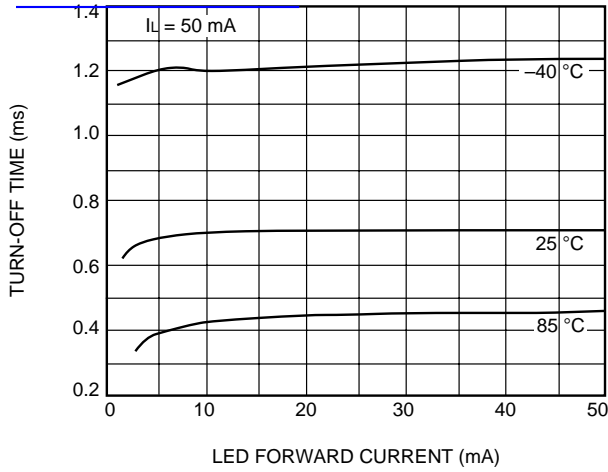

**B. Turn-Off Time vs. LED Current (LH1516, LH1519)**

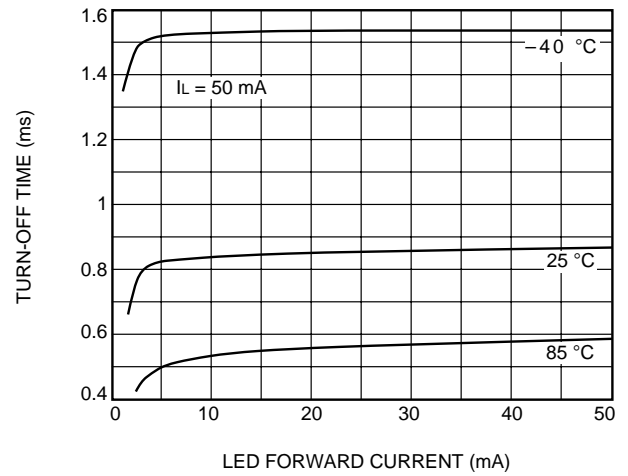

**C. Turn-Off Time vs. LED Current (LH1517)**

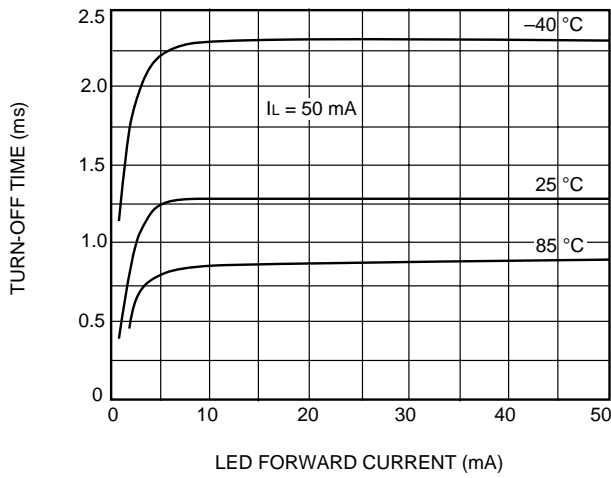

**D. Turn-Off Time vs. LED Current (LH1525)**

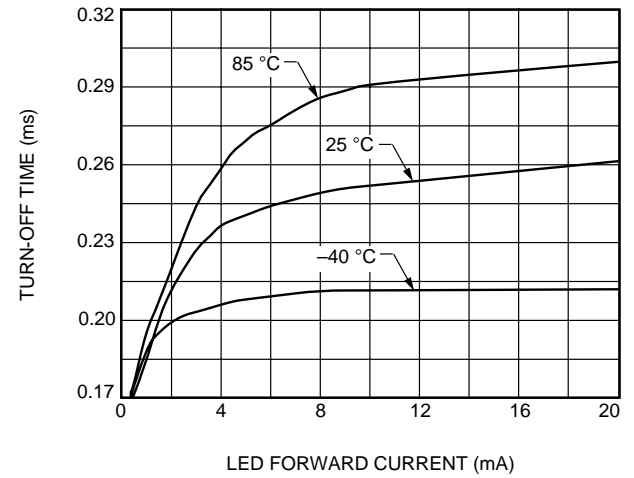

**E. Turn-Off Time vs. LED Current (LH1541)**

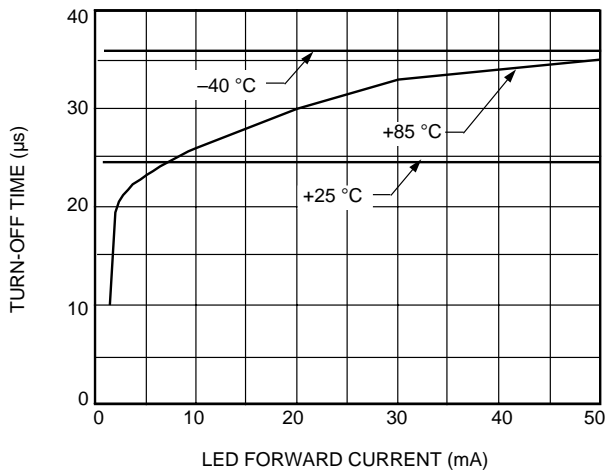

Typical Performance Characteristics, LH1550

查询“LH1504”供应商

A. LED Voltage vs. Temperature

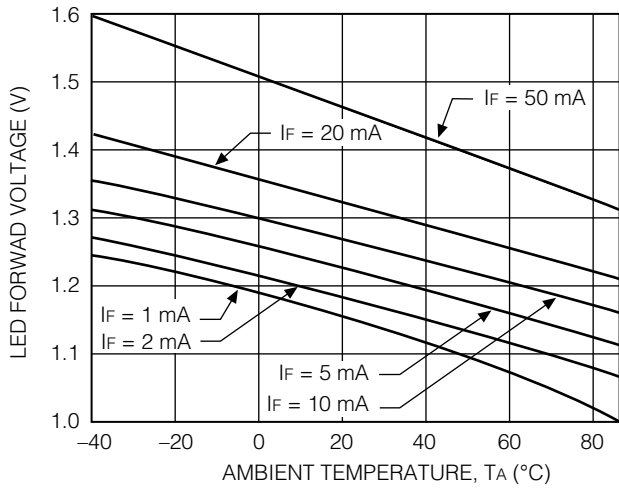

B. LED Current for Switch Turn-On/Off vs. Temperature

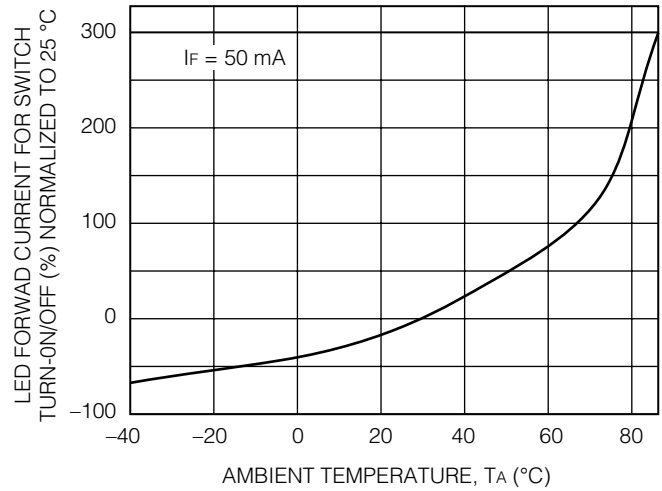

C. Current Limit vs. Temperature

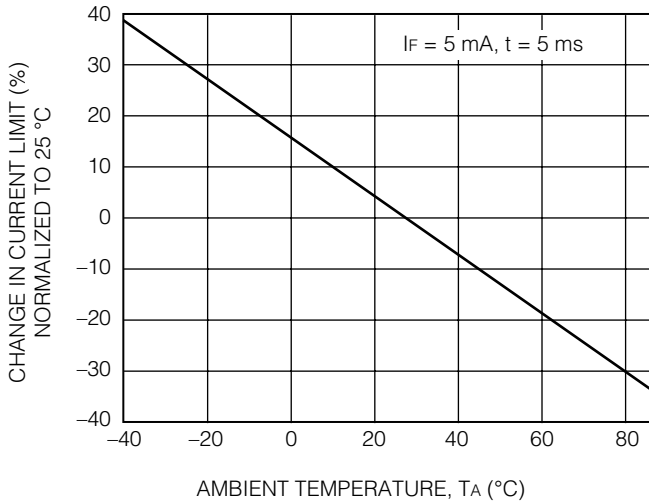

D. ON-Resistance vs. Temperature

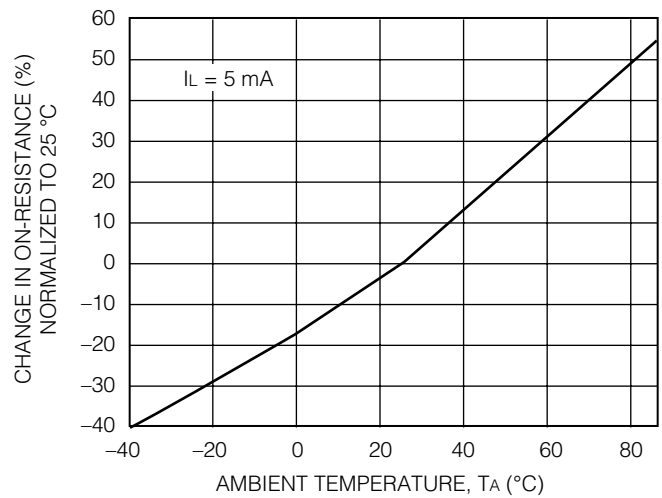

E. Turn-Off Time vs. Temperature

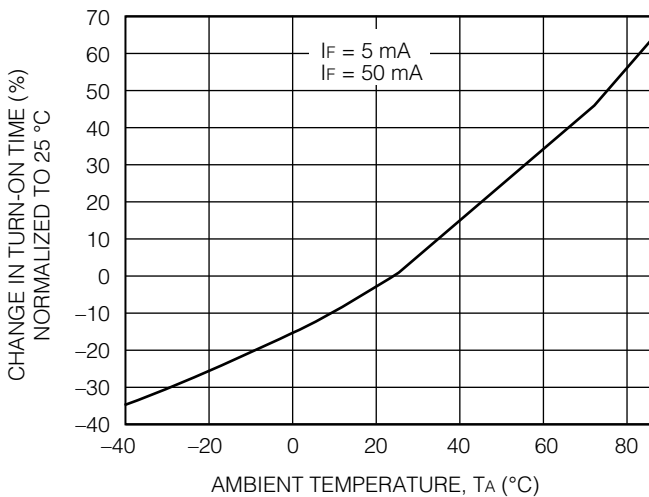

F. Turn-Off Time vs. Temperature

