

SERIES OMNEPHASE

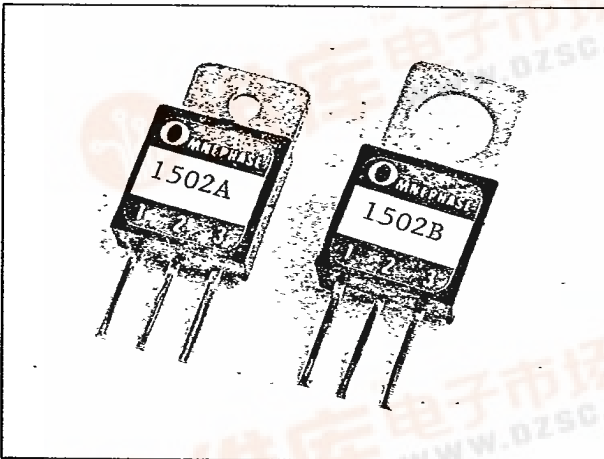

OMNEPHASE Controls provide full-wave AC phase control in a unique, high-density epoxy-encapsulated package. Capable of governing 6000 Watts @ 120V, Omnephase are rated at 6, 10 or 15 amps and operate on 120 or 230 VAC. For greater mounting flexibility, Omnephase feature three standard terminations: metal leads, wire leads and a labor-saving wire & potentiometer set-up. Designed for high performance and longevity, the active components of the Omnephase are hermetically sealed by a void-free passivation process and then epoxy-encapsulated for added environmental protection. Omnephase have exhibited superior performance in a wide variety of applications.

FEATURES

- Thick film technology
- Simple 3 terminal hook-up
- Twin timing capacitors for low Hysteresis effect
- Compact in size
- Heat sink or potentiometer mounting
- Epoxy-encapsulated circuit
- Low cost

APPLICATIONS

- SPEED CONTROL** for fans, power tools, blenders, heat guns, conveyor drives, hair dryers, mixers, Bio-medical equipment and universal, induction and subfractional H.P. motors.
- DIMMER CONTROL** for incandescent lamps.
- SHUNT FEEDBACK CONTROL** system.
- TEMPERATURE CONTROL** for soldering irons, soldering pots, molding machines, heating equipment, vending machines and photographic development equipment.
- CONTROL POWER** supplied to a remote load.
- HEATER ELEMENT CONTROL**

CONNECTION DIAGRAMS

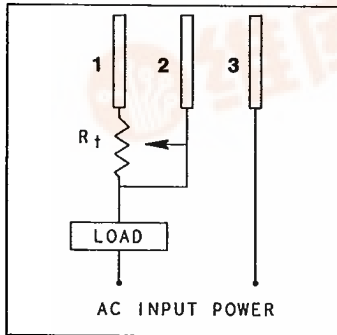

Standard Connection

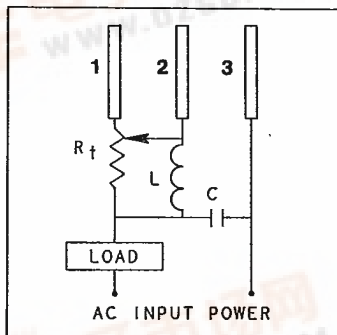

Standard Connection with RFI added*

Recommended values:
L = 100 Micro Henry
C = .1 mf 400 Volt

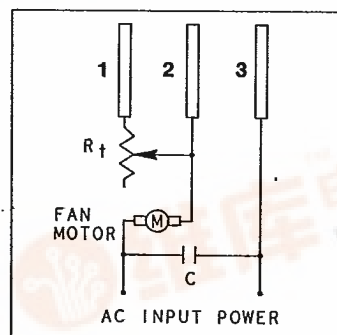

Fan Speed Control with RFI added*

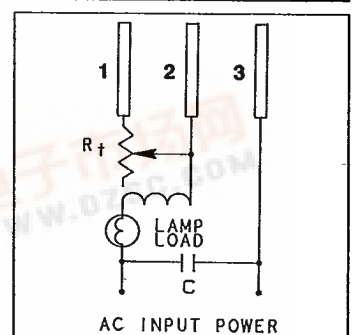

Switched Rt; Replacing Potentiometer

Typical applications include Blenders, Mixers, Heater Controls, Lamp Dimmers, Speed Controls
*supplied by customer

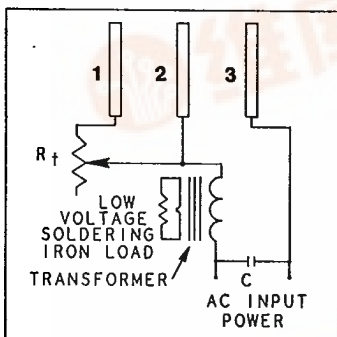

Temperature Control for Transformer Type Soldering Irons

MOUNTING

"A" Style: designed to be riveted or bolted Omnephase to a chassis or heat sink

"B" Style: designed to mount directly onto Omnephase: the 3/8" shaft of a potentiometer.

Note: ICM's Omnephase controls should be mounted to a clean, unpainted, metal or other thermally conductive surface for maximum heat dissipation. It is recommended that a heat sink compound such as Dow Corning #340 be applied between the control and the mounting surface.

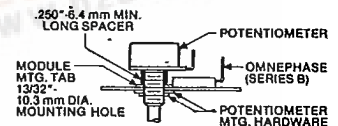

All features and specifications are subject to change without notice.

Contact our Engineering Group for application assistance.



OMNEPHASE

AC POWER CONTROLS

查询"1002A"供应商

SPECIFICATIONS

Phase Control

- Low hysteresis effect
- Full wave control

Input

- 115 or 230 VAC RMS
- Frequency: 50/60 cycles

Output

- Triac-full wave AC
- Rating Max: 2, 6, 10 and 15 amps
Min: 40 milliamps
- Hysteresis: 15% typical
- Forward Voltage Drop: 1.5 volts
- Leakage Current: 1.5 milliamperes
- Off State Voltage: 400 Volts
- Peak Surge on State Current: 10 times related current for 1 cycle @60 HZ

Protection

- Dielectric Insulation: lead to tab 1500 volts RMS

Environmental

- Operating Temperature: -40 C to +95 C (measured at triac)
- Storage Temperature: -40 C to +105 C
- Humidity: 95% relative

Physical

- Mounting: See opposite page
- Termination: (3) 19/32" leads or 6" wires
- Weight: .4 ounces (10 grams)

DIMENSIONS

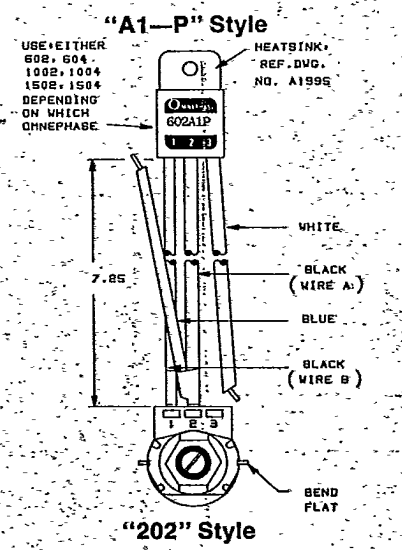
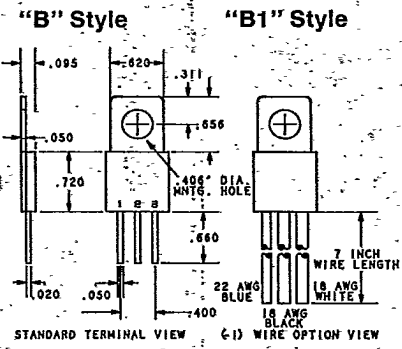
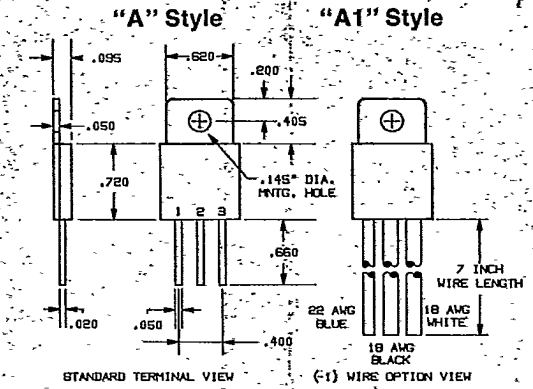

Typical Output V/S External Potentiometer

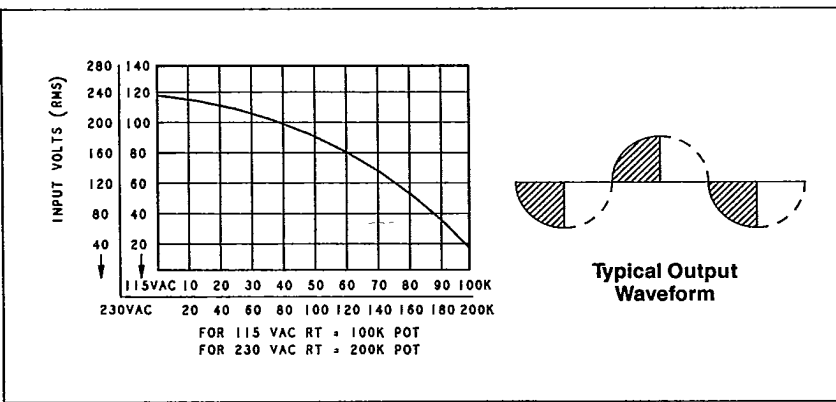

ORDERING INFORMATION: (Consult factory for variations not listed) -

TYPE = OMNEPHASE
SAMPLE PART NUMBER

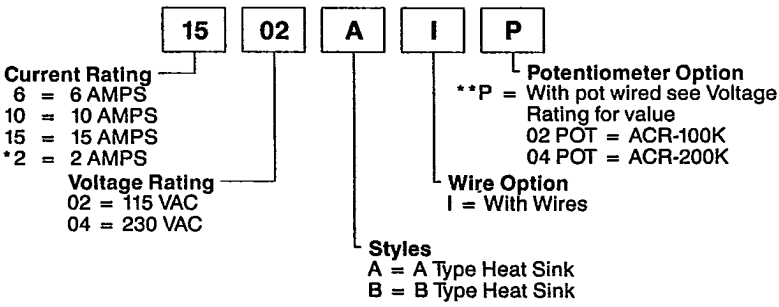

*NOTE — Wires are not available on 2 amp series
**NOTE — Potentiometer available with "A" heatsink only

All features and specifications are subject to change without notice.