

REVISIONS																													
查询"5962H9215301QNC"供应商 DESCRIPTION		DATE (YR-MO-DA)								APPROVED																			
D	Update boilerplate. Add devices 13 and 14. Add case outlines P and 9. Add CAGE 52088 as source of supply for devices 13 and 14. Editorial changes throughout.											94-06-24								M.A. Frye									
E	Changes in accordance with NOR 5962-R259-94.											94-08-08								M.A. Frye									
F	Update boilerplate. Make corrections to table IB. Add device types 15 through 18 and CAGE 65342 as source of supply. Add device type 19 and CAGE 34168 as source of supply. Editorial changes throughout.											95-11-17								M.A. Frye									
G	Changes in accordance with NOR 5962-R097-96											96-04-11								M.A. Frye									
H	Changes in accordance with NOR 5962-R122-96											96-05-06								M.A. Frye									
J	Changes in accordance with NOR 5962-R239-97											97-03-31								Ray Monnin									
K	Updated boilerplate. Added case outline "4". Corrected terminal connection pinouts for case outlines "Z" and "U". glg											97-08-27								Raymond Monnin									
REV																													
SHEET																													
REV	K	K	K	K	K	K	K	K	K	K	K	K	K	K	K	K	K	K	K										
SHEET	15	16	17	18	19	20	21	22	23	24	25	26	27	28	29	30	31	32											
REV STATUS OF SHEETS				REV				K	K	K	K	K	K	K	K	K	K	K	K										
				SHEET				1	2	3	4	5	6	7	8	9	10	11	12	13	14								
PMIC N/A				PREPARED BY Jeffery D. Bowling								DEFENSE SUPPLY CENTER COLUMBUS COLUMBUS, OHIO 43216 MICROCIRCUIT, DIGITAL, CMOS, 32K X 8 STATIC RANDOM ACCESS MEMORY (SRAM), MONOLITHIC SILICON <table border="1" style="width:100%; border-collapse: collapse;"> <tr> <td style="text-align: center;">SIZE A</td> <td style="text-align: center;">CAGE CODE 67268</td> <td style="text-align: center;">5962-92153</td> </tr> <tr> <td colspan="3" style="text-align: center;">SHEET 1 OF 32</td> </tr> </table>								SIZE A	CAGE CODE 67268	5962-92153	SHEET 1 OF 32						
SIZE A	CAGE CODE 67268	5962-92153																											
SHEET 1 OF 32																													
STANDARD MICROCIRCUIT DRAWING THIS DRAWING IS AVAILABLE FOR USE BY ALL DEPARTMENTS AND AGENCIES OF THE DEPARTMENT OF DEFENSE AMSC N/A				CHECKED BY Ray Monnin																									
				APPROVED BY Michael A. Frye																									
				DRAWING APPROVAL DATE 92-09-30																									
				REVISION LEVEL K																									

DSCC FORM 2233
 APR 97
 DISTRIBUTION STATEMENT A. Approved for public release; distribution is unlimited. 5962-E235-97

■ 9004708 0030802 336 ■

查询"6902H9215301QNC"供应商

1.1 **Scope.** This drawing documents two product assurance class levels consisting of high reliability (device classes Q and M) and space application (device class V). A choice of case outlines and lead finishes are available and are reflected in the Part or Identifying Number (PIN). When available, a choice of Radiation Hardness Assurance (RHA) levels are reflected in the PIN.

1.2 **PIN.** The PIN shall be as shown in the following example:

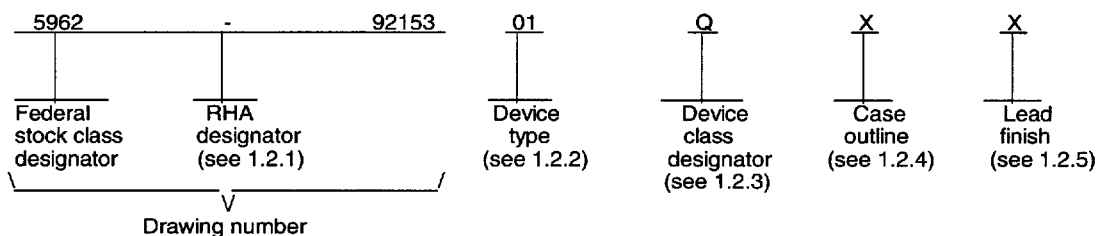

1.2.1 **RHA designator.** Device classes Q and V RHA marked devices meet the MIL-PRF-38535 specified RHA levels and are marked with the appropriate RHA designator. Device class M RHA marked devices meet the MIL-PRF-38535, appendix A specified RHA levels and are marked with the appropriate RHA designator. A dash (-) indicates a non-RHA device.

1.2.2 **Device type(s).** The device type(s) shall identify the circuit function as follows:

Device type	Generic number 1/	Circuit function	Input/output levels	Chip enable 2/	Access time
01		32K X 8 CMOS SRAM	CMOS	Dual	60 ns
02		32K X 8 CMOS SRAM	TTL	Dual	60 ns
03		32K X 8 CMOS SRAM	CMOS	Dual	40 ns
04		32K X 8 CMOS SRAM	TTL	Dual	40 ns
05		32K X 8 CMOS SRAM	CMOS	Dual	60 ns
06		32K X 8 CMOS SRAM	TTL	Dual	60 ns
07		32K X 8 CMOS SRAM	CMOS	Dual	40 ns
08		32K X 8 CMOS SRAM	TTL	Dual	40 ns
09		32K X 8 CMOS SRAM	CMOS	Single	55 ns
10		32K X 8 CMOS SRAM	TTL	Single	55 ns
11		32K X 8 CMOS SRAM	CMOS	Dual	55 ns
12		32K X 8 CMOS SRAM	TTL	Dual	55 ns
13		32K X 8 CMOS SRAM	CMOS	Dual	30 ns
14		32K X 8 CMOS SRAM	TTL	Dual	30 ns
15		32K X 8 CMOS SRAM	CMOS	Single	70 ns
16		32K X 8 CMOS SRAM	TTL	Single	70 ns
17		32K X 8 CMOS SRAM	CMOS	Dual	70 ns
18		32K X 8 CMOS SRAM	TTL	Dual	70 ns
19		32K X 8 CMOS SRAM	CMOS	Dual	35 ns

1.2.3 **Device class designator.** The device class designator shall be a single letter identifying the product assurance level as follows:

Device class	Device requirements documentation
M	Vendor self-certification to the requirements for MIL-STD-883 compliant, non-JAN class level B microcircuits in accordance with MIL-PRF-38535, appendix A
Q or V	Certification and qualification to MIL-PRF-38535

1/ Generic numbers are listed on the Standard Microcircuit Drawing Source Approval Bulletin at the end of this document and will also be listed in QML-38535.

2/ Any device type, when ordered in case outline "M" or "9", is single chip enable.

STANDARD MICROCIRCUIT DRAWING DEFENSE SUPPLY CENTER COLUMBUS COLUMBUS, OHIO 43216	SIZE A		5962-92153
		REVISION LEVEL K	SHEET 2

1.2.4 Case outline(s). The case outline shall be as designated in MIL-STD-1835 and as follows:

Outline letter	Descriptive designator	Terminals	Package style
X	See figure 1	36	Flat pack
Y	See figure 1	40	Flat pack
Z	See figure 1	36	Flat pack
U	See figure 1	36	Flat pack
T	See figure 1	36	Flat pack
M	GDIP1-T28 or CDIP2-T28	28	Dual-in-line
N	See figure 1	36	Flat pack
9	See figure 1	28	Flat pack
4	See figure 1	36	Flat pack

1.2.5 Lead finish. The lead finish is as specified in MIL-PRF-38535 for device classes Q and V or MIL-PRF-38535, appendix A for device class M.

1.3 Absolute maximum ratings. 3/ 4/

Supply voltage range (V_{CC})	-----	-0.5 V dc to +7.0 V dc
DC input voltage range (V_{IN})	-----	-0.5 V dc to $V_{CC} + 0.3$ V dc
DC output voltage range (V_{OUT})	-----	-0.5 V dc to $V_{CC} + 0.3$ V dc
Storage temperature range	-----	-65°C to +150°C
Lead temperature (soldering, 5 seconds)	-----	+250°C
Thermal resistance, junction-to-case (Θ_{JC}):		
Cases X and Y	-----	3.3C/watt
Cases Z, U, and 4	-----	2.2C/watt.
Case T	-----	10C/watt
Case M	-----	See MIL-STD-1835
Case N	-----	2.1C/watt
Case 9	-----	1.8C/watt
Output voltage applied to high Z state	-----	-0.3 V dc to $V_{CC} + 0.3$ V dc
Maximum power dissipation (P_D)	-----	2 watts
Maximum junction temperature (T_J)	-----	+150°C 5/

1.4 Recommended operating conditions.

Supply voltage range (V_{CC})	-----	4.5 V dc (min) to 5.5 V dc (max)
Supply voltage (V_{SS})	-----	0.0 V dc
High level input voltage range (V_{IH}):		
Device types 01,03,09,11,13,15,17 (CMOS levels)	-----	3.5 V dc to $V_{CC} + 0.3$ V dc
Device types 05,07,19 (CMOS levels)	-----	0.7 x V_{CC} to $V_{CC} + 0.3$ V dc
Device types 02,04,06,08,10,12,14,16,18 (TTL levels)	-----	2.2 V dc to $V_{CC} + 0.3$ V dc
Low level input voltage range (V_{IL}):		
Device types 01,03,09,11,13,15,17 (CMOS levels)	-----	-0.3 V dc to 1.5 V dc
Device types 05,07,19 (CMOS levels)	-----	-0.3 V dc to 0.3 x V_{CC}
Device types 02,04,06,08,10,12,14,16,18 (TTL levels)	-----	-0.3 V dc to 0.8 V dc
Case operating temperature range (T_C)	-----	-55°C to +125°C

1.5 Digital logic testing for device classes Q and V.

Fault coverage measurement of manufacturing logic tests (MIL-STD-883, test method 5012)	-----	100 percent
---	-------	-------------

2. APPLICABLE DOCUMENTS

2.1 Government specification, standards, and handbooks. The following specification, standards, and handbooks form a part of this drawing to the extent specified herein. Unless otherwise specified, the issues of these documents are those listed in the issue of the Department of Defense Index of Specifications and Standards (DoDISS) and supplement thereto, cited in the solicitation.

3/ Stresses above the absolute maximum rating may cause permanent damage to the device. Extended operation at the maximum levels may degrade performance and affect reliability.

4/ All voltages referenced to V_{SS} (V_{SS} = ground), unless otherwise specified.

5/ Maximum junction temperature may be increased to +175°C during burn-in and steady-state life.

STANDARD MICROCIRCUIT DRAWING DEFENSE SUPPLY CENTER COLUMBUS COLUMBUS, OHIO 43216	SIZE A		5962-92153
		REVISION LEVEL K	SHEET 3

DSCC FORM 2234
APR 97

9004708 0030804 109

上海"15301QNC"供应商

MILITARY

MIL-PRF-38535 - Integrated Circuits, Manufacturing, General Specification for.

STANDARDS

MILITARY

MIL-STD-883 - Test Methods and Procedures for Microelectronics.
MIL-STD-973 - Configuration Management.
MIL-STD-1835 - Microcircuit Case Outlines.

HANDBOOKS

MILITARY

MIL-HDBK-103 - List of Standard Microcircuit Drawings (SMD's).
MIL-HDBK-780 - Standardized Military Drawings.

(Unless otherwise indicated, copies of the specification, standards, and handbooks are available from the Standardization Document Order Desk, 700 Robbins Avenue, Building 4D, Philadelphia, PA 19111-5094.)

2.2 Non-Government publications. The following document(s) form a part of this document to the extent specified herein. Unless otherwise specified, the issue of the documents which are DoD adopted are those listed in the issue of the DODISS cited in the solicitation. Unless otherwise specified, the issues of documents not listed in the DODISS are the issues of the documents cited in the solicitation.

AMERICAN SOCIETY FOR TESTING AND MATERIALS (ASTM)

ASTM Standard F1192-88 - Standard Guide for the Measurement of Single Event Phenomena from Heavy Ion Irradiation of Semiconductor Devices.

(Applications for copies of ASTM publications should be addressed to the American Society for Testing and Materials, 1916 Race Street, Philadelphia, PA 19103).

ELECTRONICS INDUSTRIES ASSOCIATION (EIA)

JEDEC Standard No. 17 - A Standard Test Procedure for the Characterization of LATCH-UP in CMOS Integrated Circuits.

(Applications for copies should be addressed to the Electronics Industries Association, 2500 Wilson Boulevard, Arlington, VA 22201.)

(Non-Government standards and other publications are normally available from the organizations that prepare or distribute the documents. These documents also may be available in or through libraries or other informational services.)

2.3 Order of precedence. In the event of a conflict between the text of this drawing and the references cited herein, the text of this drawing takes precedence. Nothing in this document, however, supersedes applicable laws and regulations unless a specific exemption has been obtained.

3. REQUIREMENTS

3.1 Item requirements. The individual item requirements for device classes Q and V shall be in accordance with MIL-PRF-38535 and as specified herein or as modified in the device manufacturer's Quality Management (QM) plan. The modification in the QM plan shall not affect the form, fit, or function as described herein. The individual item requirements for device class M shall be in accordance with MIL-PRF-38535, appendix A for non-JAN class level B devices and as specified herein.

3.2 Design, construction, and physical dimensions. The design, construction, and physical dimensions shall be as specified in MIL-PRF-38535 and herein for device classes Q and V or MIL-PRF-38535, appendix A and herein for device class M.

Table with 4 columns: Standard description (STANDARD MICROCIRCUIT DRAWING DEFENSE SUPPLY CENTER COLUMBUS COLUMBUS, OHIO 43216), Size (A), Revision Level (K), and Sheet number (5962-92153, SHEET 4).

DSCC FORM 2234 APR 97

9004708 0030805 045

3.2.1 Case outline(s). The case outline(s) shall be in accordance with 1.2.4 herein and figure 1.

3.2.2 Terminal connections. The terminal connections shall be as specified on figure 2.

3.2.3 Truth table(s). The truth table(s) shall be as specified on figure 3.

3.2.4 Radiation exposure circuit. The radiation exposure circuit shall be as specified on figure 6.

3.2.5 Functional tests. Various functional tests used to test this device are contained in the appendix. If the test patterns cannot be implemented due to test equipment limitations, alternate test patterns to accomplish the same results shall be allowed. For device class M, alternate test patterns shall be maintained under document revision level control by the manufacturer and shall be made available to the preparing or acquiring activity upon request. For device classes Q and V alternate test patterns shall be under the control of the device manufacturer's Technology Review Board (TRB) in accordance with MIL-PRF-38535 and shall be made available to the preparing or acquiring activity upon request.

3.2.6 Die overcoat. Polyimide and silicone coatings are allowable as an overcoat on the die for alpha particle protection only. Each coated microcircuit inspection lot (see inspection lot as defined in MIL-PRF-38535) shall be subjected to and pass the internal moisture content test at 5000 ppm (see method 1018 of MIL-STD-883). The frequency of the internal water vapor testing shall not be decreased unless approved by the preparing activity for class M. The TRB will ascertain the requirements as provided by MIL-PRF-38535 for classes Q and V. Samples may be pulled any time after seal.

3.3 Electrical performance characteristics and postirradiation parameter limits. Unless otherwise specified herein, the electrical performance characteristics and postirradiation parameter limits are as specified in table IA and shall apply over the full case operating temperature range.

3.4 Electrical test requirements. The electrical test requirements shall be the subgroups specified in table IIA. The electrical tests for each subgroup are defined in table IA.

3.5 Marking. The part shall be marked with the PIN listed in 1.2 herein. In addition, the manufacturer's PIN may also be marked as listed in MIL-HDBK-103. For packages where marking of the entire SMD PIN number is not feasible due to space limitations, the manufacturer has the option of not marking the "5962-" on the device. For RHA product using this option, the RHA designator shall still be marked. Marking for device classes Q and V shall be in accordance with MIL-PRF-38535. Marking for device class M shall be in accordance with MIL-PRF-38535, appendix A.

3.5.1 Certification/compliance mark. The certification mark for device classes Q and V shall be a "QML" or "Q" as required in MIL-PRF-38535. The compliance mark for device class M shall be a "C" as required in MIL-PRF-38535, appendix A.

3.6 Certificate of compliance. For device classes Q and V, a certificate of compliance shall be required from a QML-38535 listed manufacturer in order to supply to the requirements of this drawing (see 6.6.1 herein). For device class M, a certificate of compliance shall be required from a manufacturer in order to be listed as an approved source of supply in MIL-HDBK-103 (see 6.6.2 herein). The certificate of compliance submitted to DSCC-VA prior to listing as an approved source of supply for this drawing shall affirm that the manufacturer's product meets, for device classes Q and V, the requirements of MIL-PRF-38535 and herein or for device class M, the requirements of MIL-PRF-38535, appendix A and herein.

3.7 Certificate of conformance. A certificate of conformance as required for device classes Q and V in MIL-PRF-38535 or for device class M in MIL-PRF-38535, appendix A shall be provided with each lot of microcircuits delivered to this drawing.

3.8 Notification of change for device class M. For device class M, notification to DSCC-VA of change of product (see 6.2 herein) involving devices acquired to this drawing is required for any change as defined in MIL-STD-973.

3.9 Verification and review for device class M. For device class M, DSCC, DSCC's agent, and the acquiring activity retain the option to review the manufacturer's facility and applicable required documentation. Offshore documentation shall be made available onshore at the option of the reviewer.

3.10 Microcircuit group assignment for device class M. Device class M devices covered by this drawing shall be in microcircuit group number 41 (see MIL-PRF-38535, appendix A).

4. QUALITY ASSURANCE PROVISIONS

4.1 Sampling and inspection. For device classes Q and V, sampling and inspection procedures shall be in accordance with MIL-PRF-38535 or as modified in the device manufacturer's Quality Management (QM) plan. The modification in the QM plan shall not affect the form, fit, or function as described herein. For device class M, sampling and inspection procedures shall be in accordance with MIL-PRF-38535, appendix A.

STANDARD MICROCIRCUIT DRAWING DEFENSE SUPPLY CENTER COLUMBUS COLUMBUS, OHIO 43216	SIZE A		5962-92153
		REVISION LEVEL K	SHEET 5

DSCC FORM 2234
APR 97

9004708 0030806 T&I

查询"5962H9215301QNC"供应商 TABLE IA. Electrical performance characteristics.

Test	Symbol	Conditions 1/ -55°C ≤ T _C ≤ +125°C 4.5 V ≤ V _{CC} ≤ 5.5 V unless otherwise specified	Group A subgroups	Device type	Limits		Unit						
					Min	Max							
High level output voltage	V _{OH}	V _{CC} = 4.5 V, I _{OH} = -4 mA, V _{IL} = 1.5 V, V _{IH} = 3.5 V	1,2,3	01,13	2.4		V						
				03	4.2								
				05,07, 19	4.2								
				09,11, 15,17	4.45								
		V _{CC} = 4.5 V, I _{OH} = -5 mA, V _{IL} = 1.35 V, V _{IH} = 3.15 V	1,2,3	V _{CC} = 4.5 V, I _{OH} = -200 μA, V _{IL} = 1.5 V, V _{IH} = 3.5 V	1,2,3	06,08	4.2		V				
						02,04, 10,12, 14,16, 18	2.4						
						M,D, L,R, F,G, H	1				V		
						2/	3/						
Low level output voltage	V _{OL}	V _{CC} = 4.5 V, I _{OL} = 8 mA, V _{IL} = 1.5 V, V _{IH} = 3.5 V	1,2,3	01-03, 13		0.4	V						
				05,07, 19		0.4							
				09,11, 15,17		0.05							
				04,06, 08,10, 12,14, 16,18		0.4							
		V _{CC} = 4.5 V, I _{OL} = 10 mA, V _{IL} = 1.35 V, V _{IH} = 3.15 V	1,2,3	V _{CC} = 4.5 V, I _{OL} = 200 μA, V _{IL} = 1.5 V, V _{IH} = 3.5 V	1,2,3	M,D, L,R, F,G, H	1		V				
						2/	3/						
						V _{CC} = 5.5 V, V _{IN} = 0.0 V to 5.5 V, all other pins at 0.0 V	1,2,3	V _{CC} = 5.5 V, V _{OUT} = 0.0 V to 5.5 V, all other pins at 0.0 V	1,2,3	01-08, 13,14 19	-5	5	μA
										09-12, 15-18	-10	10	
Input leakage current	I _{ILK}	V _{CC} = 5.5 V, V _{IN} = 0.0 V to 5.5 V, all other pins at 0.0 V	1,2,3	M,D, L,R, F,G, H	1		μA						
				2/	3/	3/							
Output leakage current	I _{OLK}	V _{CC} = 5.5 V, V _{OUT} = 0.0 V to 5.5 V, all other pins at 0.0 V	1,2,3	All	-10	10	μA						
				M,D, L,R, F,G, H	1			μA					
					3/	3/							

See footnotes at end of table.

STANDARD MICROCIRCUIT DRAWING DEFENSE SUPPLY CENTER COLUMBUS COLUMBUS, OHIO 43216	SIZE A		5962-92153
		REVISION LEVEL K	SHEET 6

DSCC FORM 2234
APR 97

9004708 0030807 918

TABLE 1A. Electrical performance characteristics - Continued.

Test	Symbol	Conditions 1/ -55°C ≤ T _C ≤ +125°C 4.5 V < V _{CC} ≤ 5.5 V unless otherwise specified	Group A subgroups	Device type	Limits		Unit
					Min	Max	
Data retention voltage	V _{DR}	V _{CC} = 2.5 V	1,2,3	All	2.5		V
			M,D, L,R, F,G, H	1			
Operating supply current	I _{CC1}	V _{CC} = 5.5 V, f = f _{MAX} 4/ S = GND, E = V _{CC} , no output loading	1,2,3	07,08, 13,14		180	mA
				01-06		130	
				09-12, 15-18		120	
				19		202	
			M,D, L,R, F,G, H	1			mA
			2/			3/	
Supply current (deselected)	I _{CC2}	V _{CC} = 5.5 V, f = f _{MAX} 4/ S = V _{CC} , E = GND	1,2,3	01,02, 13,14		2	mA
				03-12, 15-19		1.2	
			M,D, L,R, F,G, H	1			mA
			2/			3/	
Supply current (standby)	I _{CC3}	V _{CC} = 5.5 V, f = 0.0 MHz, S = V _{CC} , E = GND	1,2,3	01,02, 13,14		2	mA
				03-12, 15-19		1.2	
			M,D, L,R, F,G, H	1			mA
			2/			3/	
Data retention current	I _{CC4}	V _{CC} = 2.5 V	1,2,3	01,02, 13,14		1	mA
				03-12, 15-19		0.4	
			M,D, L,R, F,G, H	1			mA
			2/			3/	
Input capacitance 5/	C _{IN}	V _I = 5.0 V or 0.0 V, T _A = +25°C, (see 4.4.1e) f = 1.0 MHz	4	01-04, 13,14		4	pF
				05-08, 19		6	
				09-12, 15-18		20	
Output capacitance 5/	C _{OUT}	V _O = 5.0 V or 0.0 V, T _A = +25°C, (see 4.4.1e) f = 1.0 MHz	4	01-04, 13,14		7	pF
				05-08, 19		8	
				09-12, 15-18		20	

See footnotes at end of table.

STANDARD MICROCIRCUIT DRAWING DEFENSE SUPPLY CENTER COLUMBUS COLUMBUS, OHIO 43216	SIZE A		5962-92153
		REVISION LEVEL K	SHEET 7

查询"5962H9215301QNC"供应商 TABLE 5962H9215301QNC Electrical performance characteristics - Continued.

Test	Symbol	Conditions 1/ -55°C < T _C < +125°C 4.5 V < V _{CC} < 5.5 V unless otherwise specified	Group A subgroups	Device type	Limits		Unit
					Min	Max	
Functional tests		See 4.4.1c	7,8A,8B	All			
			M,D, L,R, F,G, H	7 2/		3/	
Read cycle							
Read cycle time	t _{AVAV}		9,10,11	01,02	60		ns
				03-08	40		
				09-12, 15-18	55		
				13,14	30		
				19	35		
				M,D, L,R, F,G, H	9 2/		
Address access time	t _{AVQV}		9,10,11	01,02		60	ns
				03-08		40	
				09-12, 15-18		55	
				13,14		30	
				19		35	
				M,D, L,R, F,G, H	9 2/		
Chip enable/select access time	t _{EHQV} t _{SLQV}		9,10,11	01,02		60	ns
				03-08		40	
				09-12, 15-18		55	
				13,14		30	
				19		35	
				M,D, L,R, F,G, H	9 2/		

See footnotes at end of table.

STANDARD MICROCIRCUIT DRAWING DEFENSE SUPPLY CENTER COLUMBUS COLUMBUS, OHIO 43216	SIZE A		5962-92153
		REVISION LEVEL K	SHEET 8

DSCC FORM 2234
APR 97

9004708 0030809 790

查询"5962H9215301QNC" 供应商

TABLE A. Electrical performance characteristics - Continued.

Test	Symbol	Conditions 1/ -55°C < T _C < +125°C 4.5 V < V _{CC} < 5.5 V unless otherwise specified	Group A subgroups	Device type	Limits		Unit
					Min	Max	
Output hold after address change	t _{AVQX}		9,10,11	01-18	5		ns
				19	5.5		
			M,D, L,R, F,G, H	9			
			2/		3/		
Output enable access time	t _{GLQV}		9,10,11	01,03, 09-12, 14-18		15	ns
				02,04		18	
				05-08, 19		10	
				13		12	
			M,D, L,R, F,G, R	9			
			2/		3/		
Chip select/enable to output active	t _{SLQX} t _{EHQX} 6/		9,10,11	01-08, 13,14, 19	3		ns
				09-12, 15-18	0		
			M,D, L,R, F,G, H	9			
			2/		3/		
Output enable to output active	t _{GLQX}		9,10,11	01-04, 13,14	3		ns
				05-12, 15-19	0		
			M,D, L,R, F,G, H	9			
			2/		3/		
Chip select/disable to output disable	t _{SHQZ} t _{ELQZ}	6/	9,10,11	01-04		15	ns
				13,14		12	
				05-08, 19		15	
				09-12, 15-18		20	
		M,D, L,R, F,G, H	9				
			2/		3/		
		7/					

See footnotes at end of table.

STANDARD MICROCIRCUIT DRAWING DEFENSE SUPPLY CENTER COLUMBUS COLUMBUS, OHIO 43216	SIZE A		5962-92153
		REVISION LEVEL K	SHEET 9

DSCC FORM 2234
APR 97

9004708 0030810 402

查询"5962H9215301QNC"供应商 TABLE A. Electrical performance characteristics - Continued.

Test	Symbol	Conditions 1/ -55°C ≤ T _C ≤ +125°C 4.5 V < V _{CC} ≤ 5.5 V unless otherwise specified	Group A subgroups	Device type	Limits		Unit
					Min	Max	
Output enable to output disable	t _{GHQZ}	6/	9,10,11	01-04		15	ns
				13,14		12	
		7/		05-08, 19		10	
				09-12, 15-18		15	
		M,D, L,R, F,G, H	9 2/			3/	ns
Write cycle							
Write enable to output disable	t _{WLQZ}	6/	9,10,11	01-04,		15	ns
				13,14		12	
		7/		05-08, 19		10	
				09-12		20	
				15-18		25	
		M,D, L,R, F,G, H	9 2/			3/	ns
Data setup to end of write	t _{DVWH}		9,10,11	01,02, 09-12	40		ns
				05,06, 15-18	50		
				03,04, 07,08	30		
				13,14	25		
				19	27		
		M,D, L,R, F,G, H	9 2/			3/	ns
Data hold after end of write	t _{WHDX}		9,10,11	01,02, 04, 09-12	5		ns
				03,13, 14	3		
				05-08, 15-19	0		
		M,D, L,R, F,G, H	9 2/			3/	ns

See footnotes at end of table.

STANDARD MICROCIRCUIT DRAWING DEFENSE SUPPLY CENTER COLUMBUS COLUMBUS, OHIO 43216	SIZE A		5962-92153
		REVISION LEVEL K	SHEET 10

DSCC FORM 2234
APR 97

9004708 0030811 349

TABLE IA. Electrical performance characteristics - Continued.

Test	Symbol	Conditions 1/ -55°C < T _C < +125°C 4.5 V < V _{CC} < 5.5 V unless otherwise specified	Group A subgroups	Device type	Limits		Unit
					Min	Max	
Output active after end of write	t _{WHQX}		9,10,11	01,02	3		ns
				03,04, 13,14	1		
				05-08, 19	5		
				09-12, 15-18	0		
			M,D, L,R, F,G, H	9 2/		3/	ns
Write cycle time	t _{AVAV} 8/		9,10,11	01,02, 05,06	60		ns
				09-12	55		
				03,04, 07,08	40		
				13,14, 19	35		
			M,D, L,R, F,G, H	9 2/		3/	ns
Chip enable/select to end of write	t _{SLWH} t _{EHWH}		9,10,11	01,02, 05,06	55		ns
				09-12	50		
				03,04, 07,08	35		
				13,14	30		
			M,D, L,R, F,G, H	9 2/		3/	ns
Address setup to end of write	t _{AVWH}		9,10,11	01,02, 05,06	55		ns
				09-12	40		
				03,04, 07,08	35		
				13,14, 19	30		
			M,D, L,R, F,G, H	9 2/		3/	ns

See footnotes at end of table.

STANDARD MICROCIRCUIT DRAWING DEFENSE SUPPLY CENTER COLUMBUS COLUMBUS, OHIO 43216	SIZE A		5962-92153
		REVISION LEVEL K	SHEET 11

DSCC FORM 2234
APR 97

9004708 0030812 285

查询"5962H9215301QNC"供应商. Electrical performance characteristics - Continued.

Test	Symbol	Conditions 1/ -55°C ≤ T _C ≤ +125°C 4.5 V ≤ V _{CC} ≤ 5.5 V unless otherwise specified	Group A subgroups	Device type	Limits		Unit	
					Min	Max		
Address setup to start of write	t _{AVWL}		9,10,11	All	0		ns	
			M,D, L,R, F,G, H	9 2/		3/		ns
Write pulse width	t _{WLWH}		9,10,11	01,02, 05,06		55		ns
				03,04, 07,08		35		
				09-12		40		
				13,14, 19		30		
				15-18		50		
Address hold after end of Write	t _{WHAX}		9,10,11	All	0		ns	
			M,D, L,R, F,G, H	9 2/		3/		ns
Write disable pulse width	t _{WHWL}		9,10,11	All	5		ns	
			M,D, L,R, F,G, H	9 2/		3/		ns

- 1/ AC measurements assume transition times ≤ 2 ns/volt for device type 01 and ≤ 5 ns for all other device types. For output load circuit, see figure 4 and for timing waveforms, see figure 5.
- 2/ When performing postirradiation electrical measurements for any RHA level T_A = +25°C. Limits shown are guaranteed at T = +25°C ±5°C. The M, D, L, R, F, G, and H in the test condition column are the postirradiation limits for the device types specified in the device types column.
- 3/ Preirradiation values for RHA marked devices shall also be the postirradiation values, unless otherwise specified.
- 4/ f_{MAX} = 1/t_{AVAV} (minimum). For devices 05-08 and 19 only, f_{MAX} = 1/t_{AVAV} (minimum write cycle time).
- 5/ Tested initially and after any design or process changes which may affect that parameter, and therefore shall be guaranteed to the limits specified in table 1A.
- 6/ Transition is measured ±500 mV from steady-state voltage.
- 7/ Transition is measured ±400 mV from steady-state voltage.
- 8/ Outputs disabled for device types 05-12 and 15-19.

STANDARD MICROCIRCUIT DRAWING DEFENSE SUPPLY CENTER COLUMBUS COLUMBUS, OHIO 43216	SIZE A		5962-92153
		REVISION LEVEL K	SHEET 12

DSCC FORM 2234
APR 97

9004708 0030813 111

Device type	T _A = Temperature ±10°C <u>3/</u>	Memory pattern	V _{CC} = 4.5 V		Bias for latch-up test V _{CC} = 5.5 V no latch-up LET = <u>3/</u>
			Effective LET no upsets [MEV/(mg/cm ²)]	Maximum device cross section (cm ²) (LET = 120)	
01-04, 13,14	+125°C	<u>4/</u>	> 120	≤ 0.00262	> 120
05,06	+125°C	<u>4/</u>	> 50	≤ 0.0319	≥ 120
07,08	+125°C	<u>4/</u>	≥ 28	< 0.0319	≥ 120
09-12, 15-18	+125°C	<u>4/</u>	> 45	≤ 0.1	≥ 120
19	+125°C	<u>4/</u>	≥ 10	≤ 0.0319	> 120

- 1/ For SEP test conditions, see 4.4.4 herein.
- 2/ Technology characterization and model verification supplemented by in-line data may be used in lieu of end-of-line testing. Test plan must be approved by TRB and qualifying activity.
- 3/ Worst case temperature T_A = +125°C.
- 4/ Testing shall be performed using checkerboard and checkerboard bar test patterns. For device class M, sampling and inspection procedures shall be in accordance with MIL-STD-883 (see 4.1 herein).

STANDARD MICROCIRCUIT DRAWING DEFENSE SUPPLY CENTER COLUMBUS COLUMBUS, OHIO 43216	SIZE A		5962-92153
		REVISION LEVEL K	SHEET 13

DSCC FORM 2234
APR 97

■ 9004708 0030814 058 ■

Line no.	Test requirements	Subgroups (in accordance with MIL-STD-883, method 5005, table I)		
		Device class M	Device class Q	Device class V
1	Interim electrical parameters (see 4.2)			1,7,9
2	Static burn-in I and II (method 1015)	Not required	Not required	Required
3	Same as line 1			1*,7* Δ
4	Dynamic burn-in (method 1015)	Required	Required	Required
5	Same as line 1			1*,7* Δ
6	Final electrical parameters	1*,2,3,7*, 8A,8B,9,10, 11	1*,2,3,7*, 8A,8B,9,10, 11	1*,2,3,7*, 8A,8B,9, 10,11
7	Group A test requirements	1,2,3,4**,7, 8A,8B,9,10, 11	1,2,3,4**,7, 8A,8B,9,10, 11	1,2,3,4**,7, 8A,8B,9,10, 11
8	Group C end-point electrical parameters	2,3,7, 8A,8B	1,2,3,7, 8A,8B	1,2,3,7, 8A,8B,9, 10,11 Δ
9	Group D end-point electrical parameters	2,3, 8A,8B	2,3, 8A,8B	2,3, 8A,8B
10	Group E end-point electrical parameters	1,7,9	1,7,9	1,7,9

- 1/ Blank spaces indicate tests are not applicable.
- 2/ Any or all subgroups may be combined when using high-speed testers.
- 3/ Subgroups 7 and 8 functional tests shall verify the truth table.
- 4/ * indicates PDA applies to subgroup 1 and 7.
- 5/ ** see 4.4.1e.
- 6/ See 4.4.1d.
- 7/ Δ indicates delta limit (see table IIB) shall be required where specified, and the delta values shall be computed with reference to the previous interim electrical parameters (see line 1). For device class V performance of delta limits shall be as specified in the manufacturer's QM plan.

STANDARD MICROCIRCUIT DRAWING DEFENSE SUPPLY CENTER COLUMBUS COLUMBUS, OHIO 43216	SIZE A		5962-92153
		REVISION LEVEL K	SHEET 14

DSCC FORM 2234
APR 97

■ 9004708 0030815 T94 ■

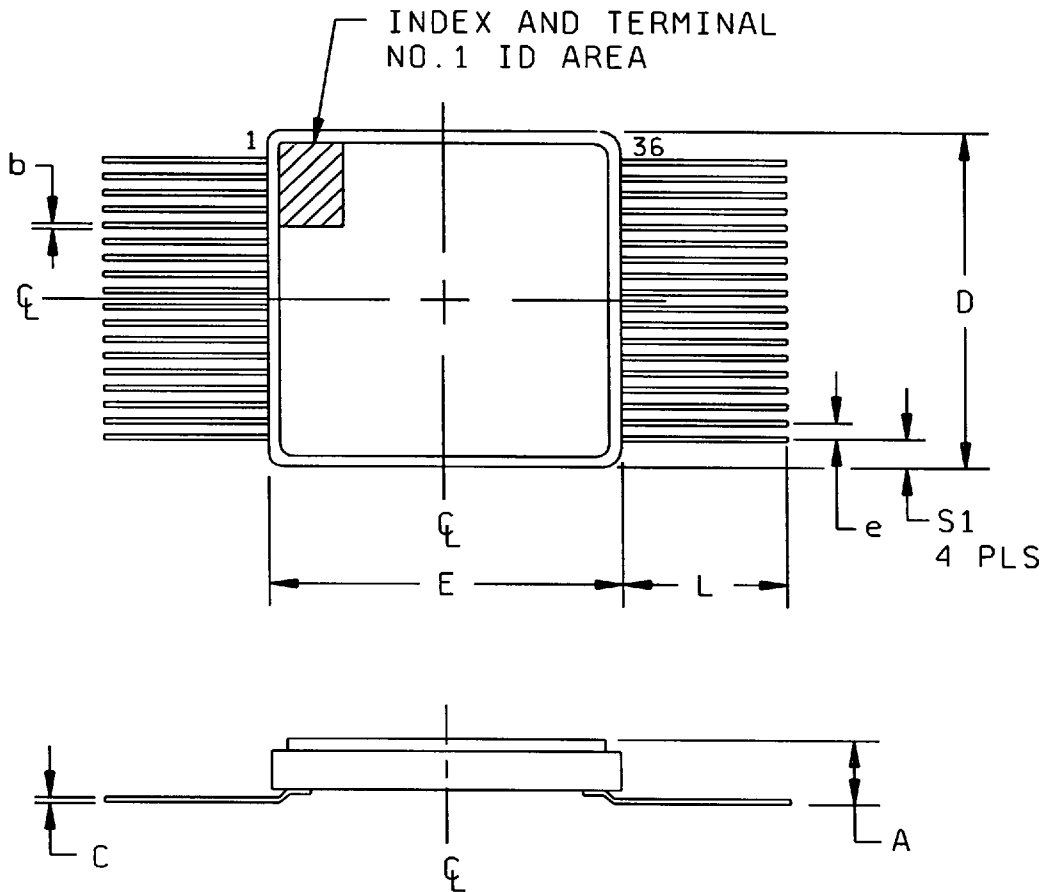

Symbol	Inches		Millimeters	
	Min	Max	Min	Max
A	.075	.125	1.91	2.41
b	.007	.010	.18	.25
S1	.103	.123	2.62	3.12
c	.004	.006	.11	.15
D	.640	.660	16.26	16.76
E	.623	.637	15.82	16.18
e	0.025 BSC		0.64 BSC	
L	.235	.300	5.96	7.24

FIGURE 1. Case outlines.

STANDARD MICROCIRCUIT DRAWING DEFENSE SUPPLY CENTER COLUMBUS COLUMBUS, OHIO 43216	SIZE A		5962-92153
		REVISION LEVEL K	SHEET 15

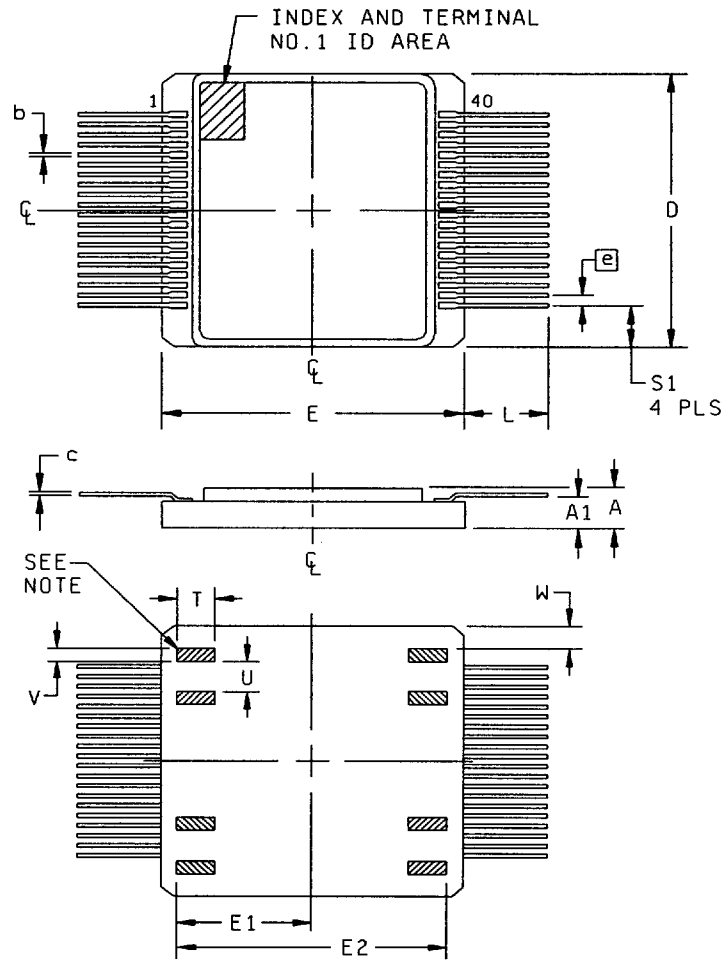

Symbol	Inches		Millimeters	
	Min	Max	Min	Max
A	.066	.078	1.68	1.98
A1	.060	.076	1.53	1.93
b	.007	.010	.18	.25
S1	.078	.098	1.98	2.48
c	.004	.006	.11	.15
D	.640	.660	16.26	16.76
E	.768	.783	19.48	19.88
E1	.350 REF		8.89 REF	

Symbol	Inches		Millimeters	
	Min	Max	Min	Max
E2	.700 REF		17.78 REF	
e	0.025 BSC		0.64 BSC	
L	.238	.288	6.04	7.32
T	.100 REF		2.54 REF	
U	.080 REF		2.03 REF	
V	.040 REF		1.02 REF	
W	.045 REF		1.14 REF	

NOTE: The indicated terminal pad is P1. Terminal pads are numbered clockwise (bottom view) through P8.

FIGURE 1. Case outlines - Continued.

STANDARD MICROCIRCUIT DRAWING DEFENSE SUPPLY CENTER COLUMBUS COLUMBUS, OHIO 43216	SIZE A		5962-92153
		REVISION LEVEL K	SHEET 16

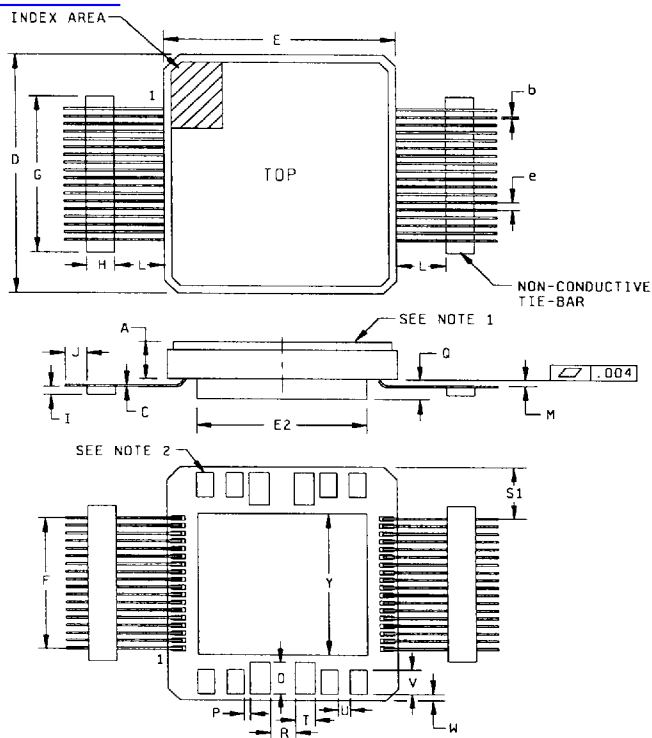

Symbol	Inches		Millimeters	
	Min	Max	Min	Max
A	.085	.105	2.16	2.67
b	.006	.010	.15	.25
C	.0050	.0075	.127	.191
D	.640	.660	16.26	16.76
E	.623	.637	15.82	16.18
E2	0.450 REF		11.43 REF	
e	0.025 BSC		0.64 BSC	
F	.420	.430	10.67	10.92
G	0.525 REF		13.34 REF	
H	0.135 REF		3.43 REF	
I	.025	.035	.64	.89
J	0.080 REF		2.03 REF	

Symbol	Inches		Millimeters	
	Min	Max	Min	Max
L	.270	.300	6.86	7.62
M	.005	.011	.13	.28
O	0.090 REF		2.29 REF	
P	0.015 REF		0.38 REF	
Q	.040	.060	1.02	1.52
R	0.075 REF		1.91 REF	
S1	.103	.123	2.62	3.12
T	0.050 REF		1.27 REF	
U	0.030 REF		0.76 REF	
V	0.080 REF		2.03 REF	
W	0.005 REF		0.13 REF	
Y	0.400 REF		10.16 REF	

NOTES: 1. Lid tied to V_{SS}.
 2. The indicated terminal pad is P1. Terminal pads are numbered clockwise (bottom view) through P12.

FIGURE 1. Case outlines - Continued.

STANDARD MICROCIRCUIT DRAWING DEFENSE SUPPLY CENTER COLUMBUS COLUMBUS, OHIO 43216	SIZE A		5962-92153
		REVISION LEVEL K	SHEET 17

Case U

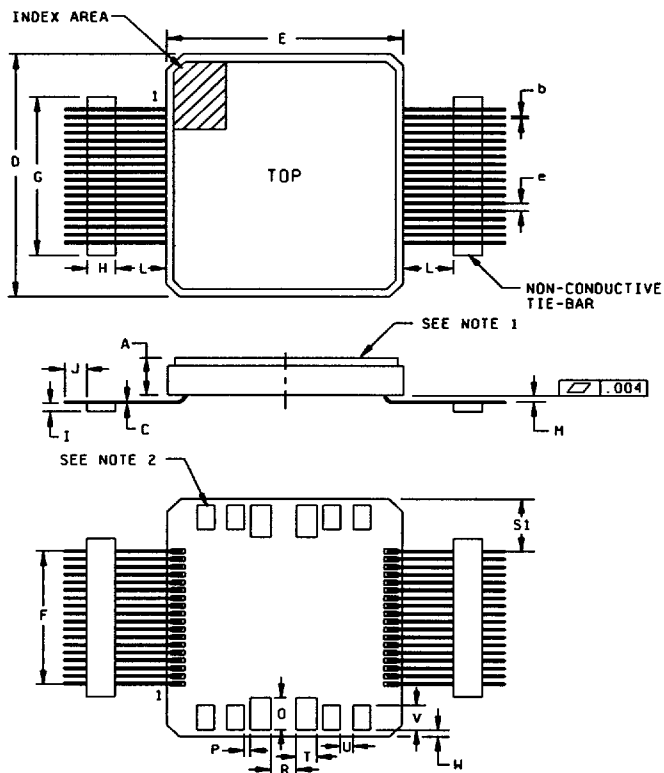

Symbol	Inches		Millimeters	
	Min	Max	Min	Max
A	.085	.105	2.16	2.67
b	.006	.010	.15	.25
C	.0050	.0075	.127	.191
D	.640	.660	16.26	16.76
E	.623	.637	15.82	16.18
e	0.025 BSC		0.64 BSC	
F	.420	.430	10.67	10.92
G	0.525 REF		13.34 REF	
H	0.135 REF		3.43 REF	
I	.025	.035	.64	.89
J	0.080 REF		2.03 REF	

Symbol	Inches		Millimeters	
	Min	Max	Min	Max
L	.270	.300	6.86	7.62
M	.005	.011	.13	.28
O	0.090 REF		2.29 REF	
P	0.015 REF		0.38 REF	
R	0.075 REF		1.91 REF	
S1	.103	.123	2.62	3.12
T	0.050 REF		1.27 REF	
U	0.030 REF		0.76 REF	
V	0.080 REF		2.03 REF	
W	0.005 REF		0.13 REF	

NOTES: 1. Lid tied to V_{SS} .
 2. The indicated terminal pad is P1. Terminal pads are numbered clockwise (bottom view) through P12.

FIGURE 1. Case outlines - Continued.

STANDARD MICROCIRCUIT DRAWING DEFENSE SUPPLY CENTER COLUMBUS COLUMBUS, OHIO 43216	SIZE A		5962-92153
		REVISION LEVEL K	SHEET 18

Case T

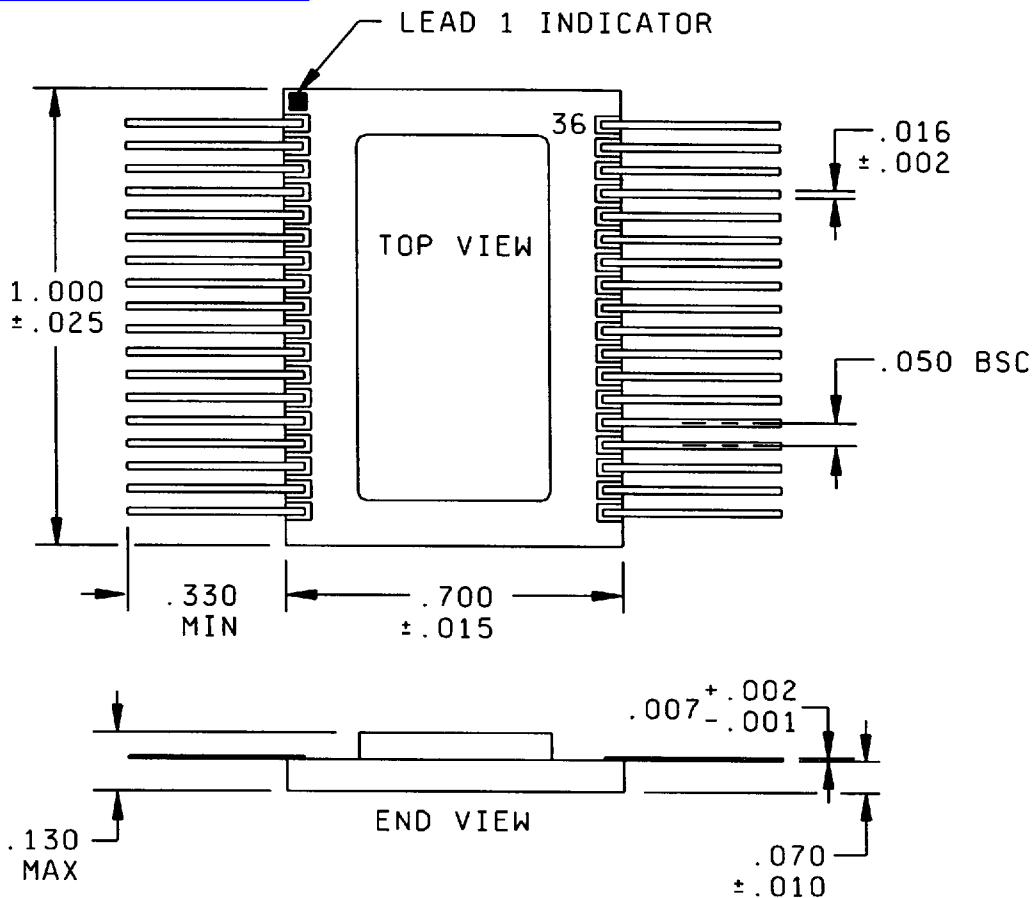

Inches	Millimeters
.001	.03
.002	.05
.007	.18
.010	.25
.015	.38
.016	.41
.025	.64
.050	1.27
.070	1.78
.130	3.30
.330	8.38
.700	17.78
1.000	25.40

FIGURE 1. Case outlines - continued.

STANDARD MICROCIRCUIT DRAWING DEFENSE SUPPLY CENTER COLUMBUS COLUMBUS, OHIO 43216	SIZE A		5962-92153
		REVISION LEVEL K	SHEET 19

DSCC FORM 2234
APR 97

9004708 0030820 351

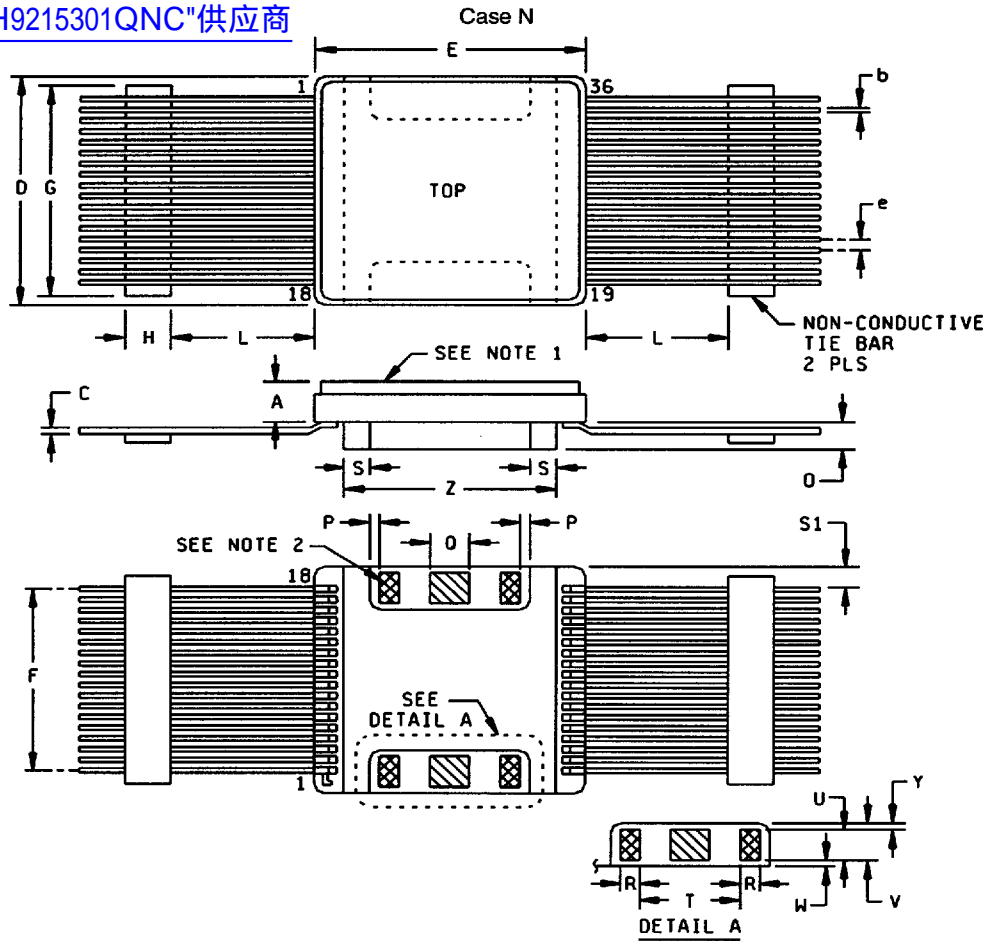

Symbol	Inches		Millimeters	
	Min	Max	Min	Max
A	.062	.082	1.57	2.09
b	.007	.010	.178	.254
C	.0050	.0075	.127	.191
D	.640	.660	16.26	16.76
E	.623	.637	15.82	16.18
e	0.025 BSC		0.64 BSC	
F	.421	.429	10.69	10.90
G	0.525 REF		13.34 REF	
H	0.135 REF		3.43 REF	
L	.270	.300	6.86	7.62

Symbol	Inches		Millimeters	
	Min	Max	Min	Max
O	.045	.055	1.14	1.40
P	.010 REF		0.254 REF	
Q	.075	.085	1.91	2.15
R	0.040 REF		1.02 REF	
S	.070	.080	1.77	2.03
S1	.103	.123	2.62	3.12
T	0.240 REF		6.10 REF	
U	0.100 REF		2.54 REF	
V	0.115 REF		2.92 REF	
W	0.005 REF		0.13 REF	
Y	0.010 REF		0.25 REF	
Z	0.490 REF		12.45 REF	

- NOTES: 1. Lid tied to V_{SS} .
 2. The indicated terminal pad is P1. Terminal pads are numbered clockwise (bottom view) through P6.

FIGURE 1. Case outlines - continued.

STANDARD MICROCIRCUIT DRAWING DEFENSE SUPPLY CENTER COLUMBUS COLUMBUS, OHIO 43216	SIZE A		5962-92153
		REVISION LEVEL K	SHEET 20

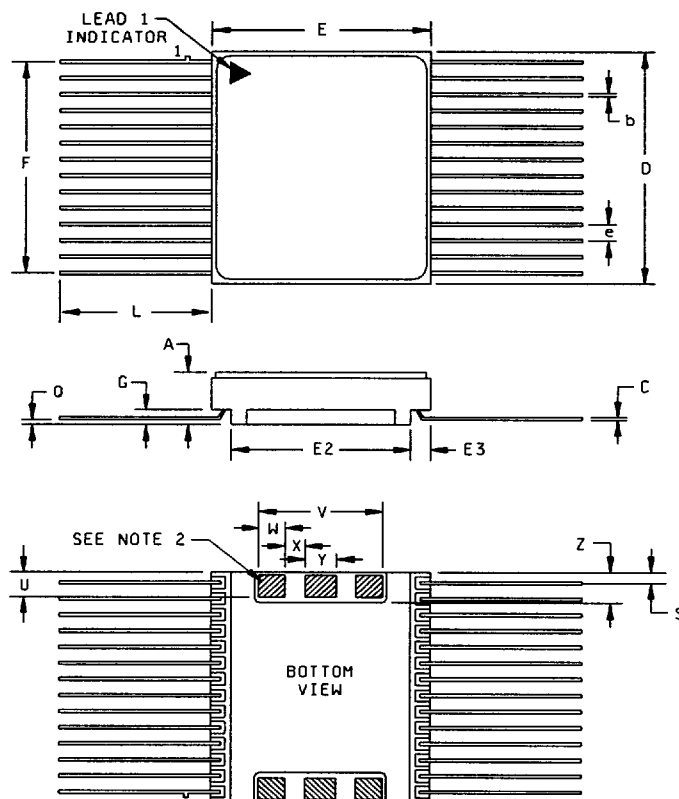

Symbol	Inches		Millimeters	
	Min	Max	Min	Max
A	.120	.150	3.05	3.81
b	.013	.017	0.33	0.43
C	.004	.009	0.10	0.23
D	.712	.728	18.08	18.49
e	0.050 BSC		1.27 BSC	
E	.522	.538	13.26	13.67
E2	.412	.428	10.46	10.87
E3	0.055 REF		13.97 REF	
F	.645	.655	16.38	16.64

Symbol	Inches		Millimeters	
	Min	Max	Min	Max
G	.045	.055	1.14	1.40
L	.295	---	7.49	---
Q	.026	.045	0.66	1.14
S	.025	.045	0.64	1.14
V	0.300 REF		7.62 REF	
W	0.050 REF		1.27 REF	
X	0.030 REF		0.76 REF	
Y	0.100 REF		2.54 REF	
Z	0.080 REF		2.03 REF	

NOTES: 1. Lid tied to GND.
 2. The indicated terminal pad is P1. Terminal pads are numbered clockwise (bottom view) through P6.

FIGURE 1. Case outlines - continued.

STANDARD MICROCIRCUIT DRAWING DEFENSE SUPPLY CENTER COLUMBUS COLUMBUS, OHIO 43216	SIZE A		5962-92153
		REVISION LEVEL K	SHEET 21

Device type	All						
Case outline	Z, U	4	X, T	Y	M	N	9
Terminal no.	Terminal symbol						
1	GND	GND	GND	NC	A ₁₄	GND	A ₁₄
2	V _{CC}	V _{CC}	V _{CC}	GND	A ₁₂	V _{CC}	A ₁₂
3	A ₁₄	A ₁₄	A ₁	V _{CC}	A ₇	A ₁	A ₇
4	A ₁₂	A ₁₂	A ₀	A ₁	A ₆	A ₀	A ₆
5	A ₇	A ₇	A ₁₀	A ₀	A ₅	A ₁₀	A ₅
6	A ₆	A ₆	A ₉	A ₁₀	A ₄	A ₉	A ₄
7	A ₅	A ₅	A ₇	A ₉	A ₃	A ₇	A ₃
8	A ₄	A ₄	A ₈	A ₇	A ₂	A ₈	A ₂
9	A ₃	A ₃	A ₁₁	A ₈	A ₁	A ₁₁	A ₁
10	A ₂	A ₂	A ₁₂	A ₁₁	A ₀	A ₁₂	A ₀
11	A ₁	A ₁	A ₁₃	A ₁₂	IO ₀	A ₁₃	IO ₀
12	A ₀	A ₀	A ₁₄	A ₁₃	IO ₁	A ₁₄	IO ₁
13	IO ₀	IO ₀	IO ₁	A ₁₃	IO ₂	IO ₁	IO ₂
14	IO ₁	IO ₁	IO ₂	IO ₁	V _{SS}	IO ₂	GND
15	IO ₂	IO ₂	IO ₃	IO ₂	IO ₃	IO ₃	IO ₃
16	NC	NC	NC	IO ₃	IO ₄	NC	IO ₄
17	V _{CC}	V _{CC}	V _{CC}	NC	IO ₅	V _{CC}	IO ₅
18	GND	GND	GND	V _{CC}	IO ₆	GND	IO ₆
19	GND	GND	GND	GND	IO ₇	GND	IO ₇
20	V _{CC}	V _{CC}	V _{CC}	NC	S	V _{CC}	S
21	IO ₃	IO ₃	IO ₄	NC	A ₁₀	IO ₄	A ₁₀
22	IO ₄	IO ₄	IO ₅	GND	G	IO ₅	G
23	IO ₅	IO ₅	IO ₆	V _{CC}	IO ₆	IO ₆	A ₁₁
24	IO ₆	IO ₆	IO ₇	IO ₄	A ₉	IO ₇	A ₉
25	IO ₇	IO ₇	IO ₈	IO ₅	A ₈	IO ₈	A ₈
26	S	S	S	IO ₆	A ₁₃	S	A ₁₃
27	A ₁₀	A ₁₀	A ₂	IO ₇	W	A ₂	W
28	G	G	G	IO ₈	V _{CC}	G	V _{CC}
29	A ₁₁	A ₁₁	A ₆	S	---	A ₆	---
30	A ₉	A ₉	A ₅	A ₂	---	A ₅	---
31	A ₈	A ₈	A ₄	G	---	A ₄	---
32	A ₁₃	E	A ₃	A ₆	---	A ₃	---
33	E	W	E	A ₅	---	E	---
34	W	A ₁₃	W	A ₄	---	W	---
35	V _{CC}	V _{CC}	V _{CC}	A ₃	---	V _{CC}	---
36	GND	GND	GND	E	---	GND	---
37	---	---	---	W	---	---	---
38	---	---	---	V _{CC}	---	---	---
39	---	---	---	GND	---	---	---
40	---	---	---	NC	---	---	---
P1	V _{CC}	V _{CC}	---	V _{CC}	---	V _{CC}	V _{CC}
P2	GND	GND	---	V _{CC}	---	GND	GND
P3	GND	GND	---	GND	---	V _{CC}	V _{CC}
P4	V _{CC}	V _{CC}	---	GND	---	V _{CC}	V _{CC}
P5	V _{CC}	V _{CC}	---	V _{CC}	---	GND	GND
P6	GND	GND	---	V _{CC}	---	V _{CC}	V _{CC}
P7	GND	GND	---	GND	---	---	---
P8	V _{CC}	V _{CC}	---	GND	---	---	---
P9	V _{CC}	V _{CC}	---	---	---	---	---
P10	GND	GND	---	---	---	---	---
P11	GND	GND	---	---	---	---	---
P12	V _{CC}	V _{CC}	---	---	---	---	---

FIGURE 2. Terminal connections.

STANDARD MICROCIRCUIT DRAWING DEFENSE SUPPLY CENTER COLUMBUS COLUMBUS, OHIO 43216	SIZE A		5962-92153
		REVISION LEVEL K	SHEET 22

Mode	Inputs (see notes 1 and 2)					Power
	(see note 3) E	S	W	G	I/O	
WRITE	HIGH	LOW	LOW	DON'T CARE	DATA-IN	ACTIVE
READ	HIGH	LOW	HIGH	LOW	DATA-OUT	ACTIVE
STANDBY	DON'T CARE	HIGH	DON'T CARE	DON'T CARE	HIGH-Z	STANDBY
STANDBY (see note 4)	LOW	DON'T CARE	DON'T CARE	DON'T CARE	HIGH-Z	STANDBY

NOTES:

1. V_{IN} for Don't Care inputs = V_{IL} OR V_{IH} .
2. When $G =$ high, I/O is High-Z.
3. E does not apply to devices in case outlines "M" or "9".
4. When in standby mode, $S = V_{CC}$ and E = GND input levels to dissipate minimum standby power. All other input levels may float.

FIGURE 3. Truth table.

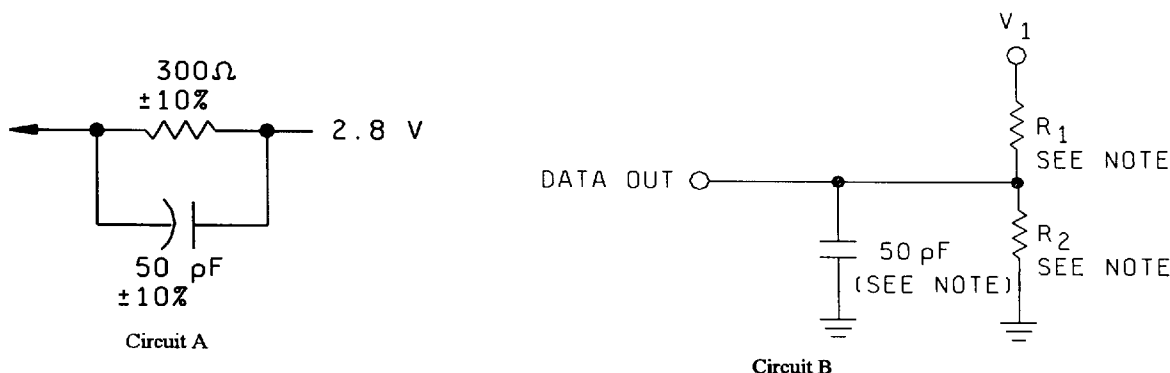

AC test conditions

	Device types		
	01,13	02,03,05,07,09,11,15,17,19	04,06,08,10,12,14,16,18
Input pulse levels	0.0 V to V_{CC}	0.5 V to $V_{CC} - 0.5$ V	0 V to 3 V
Input rise/fall times	< 2.0 ns/volt	≤ 5 ns	< 5 ns
Input timing reference	2.5 volts	$V_{CC} / 2$	1.5 V
Output timing reference	2.5 volts	$V_{CC} / 2$	1.5 V

- NOTES: Capacitance includes scope and jig (minimum values). Circuit A applies to device types 01, 03, and 13. Circuit B applies to device types 02, 04, 09-12, and 14-18, with $V_1 = 5.0$ V, $R_1 = 480$ Ω, $R_2 = 255$ Ω. For device types 05-08 and 19, $V_1 = 2.9$ V, $R_1 = 249$ Ω, R_2 is open (no resistor).

FIGURE 4. Output load circuit (see note).

STANDARD MICROCIRCUIT DRAWING DEFENSE SUPPLY CENTER COLUMBUS COLUMBUS, OHIO 43216	SIZE A		5962-92153
		REVISION LEVEL K	SHEET 23

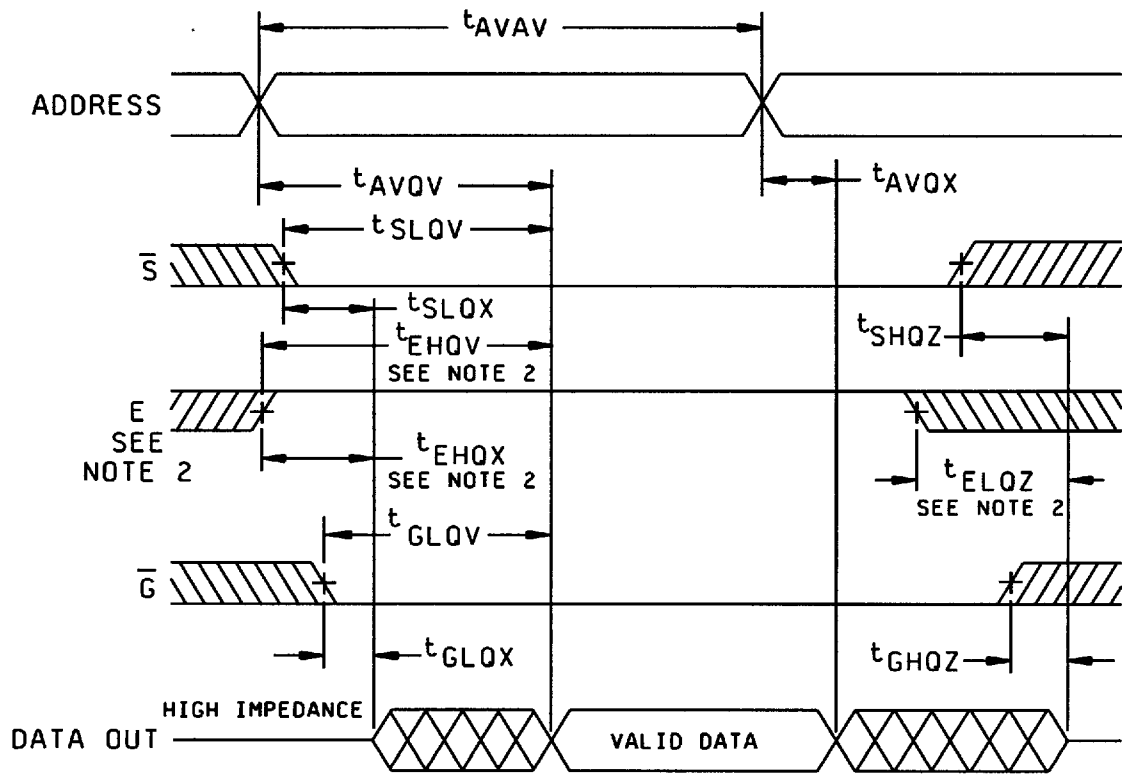

NOTE:

1. \bar{W} is high for read cycle.
2. E and timing parameters t_{EHQV} , t_{EHQX} , t_{ELQZ} do not apply to devices in case outlines "M" or "9".

FIGURE 5. Timing waveforms.

STANDARD MICROCIRCUIT DRAWING DEFENSE SUPPLY CENTER COLUMBUS COLUMBUS, OHIO 43216	SIZE A		5962-92153
		REVISION LEVEL K	SHEET 24

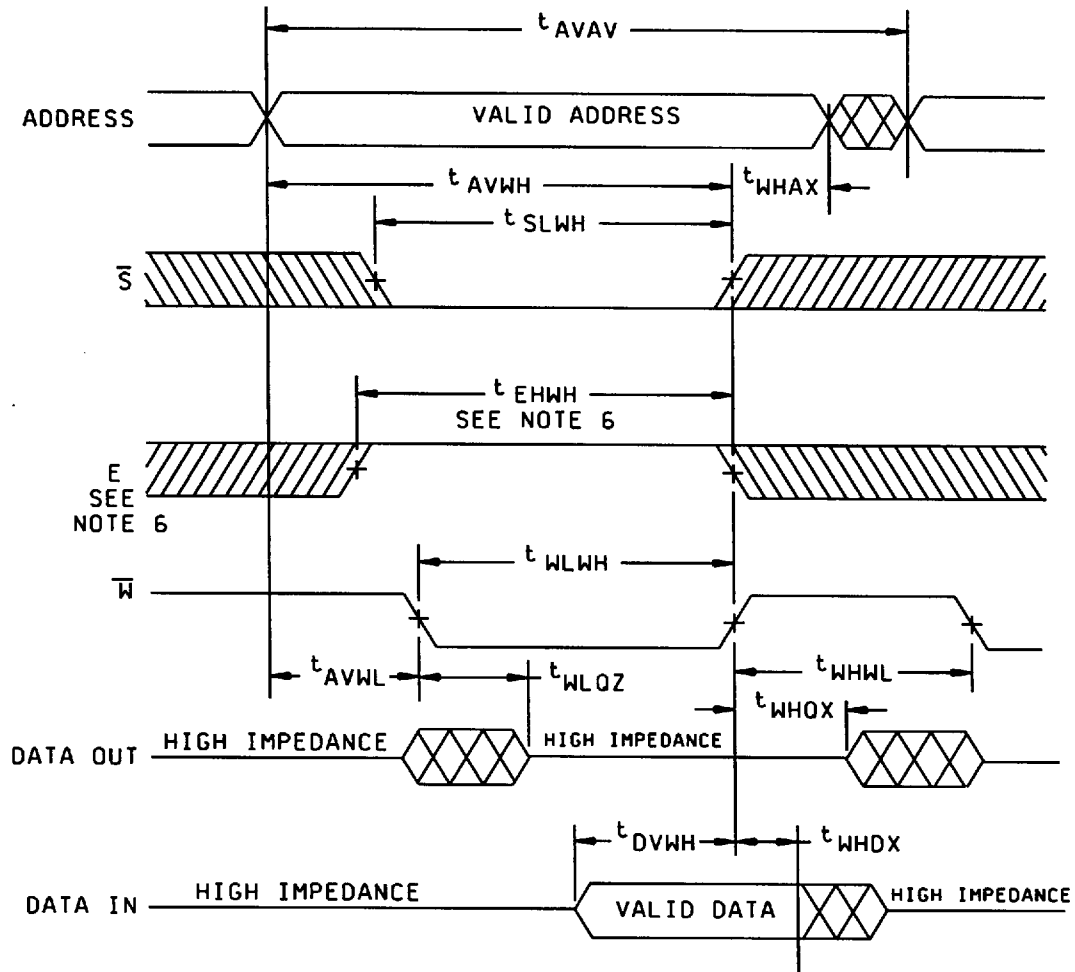

NOTES:

1. Write cycle data is latched by the first occurrence of \bar{S} high, E low or W high.
2. \bar{S} high, E low, or W high must occur while address transitions.
3. Write cycle time is guaranteed for toggling \bar{S} and E or holding \bar{S} or E, or both, in active state.
4. The worst case timing sequence of $t_{WLOZ} + t_{DVWH} + t_{WHWL}$ = the write cycle time (t_{AVAV}).
5. \bar{S} high will eliminate the I/O output from becoming active (t_{WLOZ}).
6. E and timing parameter t_{EHWL} do not apply to devices in case outlines "M" or "9".

FIGURE 5. Timing waveforms - continued.

STANDARD MICROCIRCUIT DRAWING DEFENSE SUPPLY CENTER COLUMBUS COLUMBUS, OHIO 43216	SIZE A		5962-92153
		REVISION LEVEL K	SHEET 25

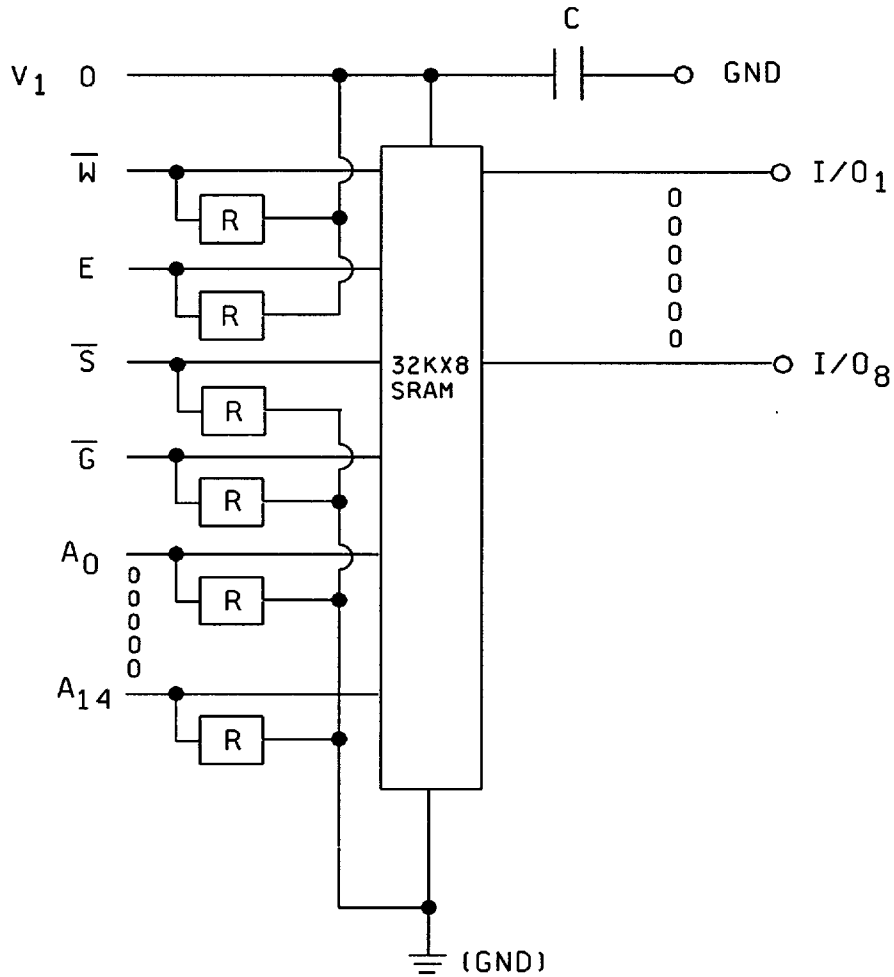

NOTES:

1. Power pins connected to V_1 .
2. The absolute voltage ratings of 1.3 shall not be exceeded.
3. ESD precautions shall be followed.
4. The pattern in the memory array will be checkerboard for irradiation and accelerated aging tests.
5. Pin conditions (E does not apply to devices in case outlines "M" or "9") :

$\bar{S} = \text{GND}$	$\bar{W} = V_{CC}$	$\bar{G} = \text{GND}$
$E = V_{CC}$	$A_0 - A_{14} = \text{GND}$	$I/O_1 - I/O_8 = \text{FLOATING}$
$V_1 = V_{CC}$	$R = 10 \text{ k}\Omega \pm 10\%$	$C = 0.1 \mu\text{F} \pm 10\%$
$V_{CC} = 5.0 \text{ V}$		

FIGURE 6. Radiation exposure circuit. (see notes)

STANDARD MICROCIRCUIT DRAWING DEFENSE SUPPLY CENTER COLUMBUS COLUMBUS, OHIO 43216	SIZE A		5962-92153
		REVISION LEVEL K	SHEET 26

	Device types
Test 1/	All
I _{CC3} standby	±10% of specified value in table IA
I _{ILK} , I _{OLK}	±10% of specified value in table IA

1/ The above parameters shall be recorded before and after the required burn-in and life tests to determine the delta.

4.2 Screening. For device classes Q and V, screening shall be in accordance with MIL-PRF-38535, and shall be conducted on all devices prior to qualification and technology conformance inspection. For device class M, screening shall be in accordance with method 5004 of MIL-STD-883, and shall be conducted on all devices prior to quality conformance inspection.

4.2.1 Additional criteria for device class M.

- a. Delete the sequence specified as initial (preburn-in) electrical parameters through interim (postburn-in) electrical parameters of method 5004 and substitute lines 1 through 6 of table IIA herein.
- b. The test circuit shall be maintained by the manufacturer under document revision level control and shall be made available to the preparing or acquiring activity upon request. The test circuit shall specify the inputs, outputs, biases, and power dissipation, as applicable, in accordance with the intent specified in test method 1015.
 - (1) Dynamic burn-in for device class M (method 1015 of MIL-STD-883, test condition D; for circuit, see 4.2.1b herein).
- c. Interim and final electrical parameters shall be as specified in table IIA herein.

4.2.2 Additional criteria for device classes Q and V.

- a. The burn-in test duration, test condition and test temperature, or approved alternatives shall be as specified in the device manufacturer's QM plan in accordance with MIL-PRF-38535. The burn-in test circuit shall be maintained under document revision level control of the device manufacturer's Technology Review Board (TRB) in accordance with MIL-I-38535 and shall be made available to the acquiring or preparing activity upon request. The test circuit shall specify the inputs, outputs, biases, and power dissipation, as applicable, in accordance with the intent specified in test method 1015.
- b. Interim and final electrical test parameters shall be as specified in table IIA herein.
- c. Additional screening for device class V beyond the requirements of device class Q shall be as specified in appendix B of MIL-PRF-38535.

4.3 Qualification inspection for device classes Q and V. Qualification inspection for device classes Q and V shall be in accordance with MIL-PRF-38535. Inspections to be performed shall be those specified in MIL-I-38535 and herein for groups A, B, C, D, and E inspections (see 4.4.1 through 4.4.4).

4.4 Conformance inspection. Technology conformance inspection for classes Q and V shall be in accordance with MIL-PRF-38535 including groups A, B, C, D, and E inspections and as specified herein except where option 2 of MIL-PRF-38535 permits alternate in-line control testing. Quality conformance inspection for device class M shall be in accordance with MIL-PRF-38535, appendix A and as specified herein. Inspections to be performed for device class M shall be those specified in method 5005 of MIL-STD-883 and herein for groups A, B, C, D, and E inspections (see 4.4.1 through 4.4.4).

4.4.1 Group A inspection.

- a. Tests shall be as specified in table IIA herein.
- b. Subgroups 5 and 6 of table I of method 5005 of MIL-STD-883 shall be omitted.

STANDARD MICROCIRCUIT DRAWING DEFENSE SUPPLY CENTER COLUMBUS COLUMBUS, OHIO 43216	SIZE A		5962-92153
		REVISION LEVEL K	SHEET 27

For device class M, subgroups 7 and 8 tests shall be sufficient to verify the truth table. For device classes Q and V, subgroups 7 and 8 shall include verifying the functionality of the device; these tests shall have been fault graded in accordance with MIL-STD-883, test method 5012 (see 1.5 herein).

- d. O/V (latch-up) tests shall be measured only for initial qualification and after any design or process changes which may affect the performance of the device. For device class M, procedures and circuits shall be maintained under document revision level control by the manufacturer and shall be made available to the preparing activity or acquiring activity upon request. For device classes Q and V, the procedures and circuits shall be under the control of the device manufacturer's TRB in accordance with MIL-PRF-38535 and shall be made available to the preparing activity or acquiring activity upon request. Testing shall be on all pins, on five devices with zero failures. Latch-up test shall be considered destructive. Information contained in JEDEC Standard number 17 may be used for reference.
- e. Subgroup 4 (C_{IN} and C_{OUT} measurements) shall be measured only for initial qualification and after any process or design changes which may affect input or output capacitance. Capacitance shall be measured between the designated terminal and GND at a frequency of 1 MHz. Sample size is 15 devices with no failures, and all input and output terminals tested.

4.4.2 Group C inspection. The group C inspection end-point electrical parameters shall be as specified in table IIA herein.

4.4.2.1 Additional criteria for device class M. Steady-state life test conditions, method 1005 of MIL-STD-883:

- a. Test condition D. The test circuit shall be maintained by the manufacturer under document revision level control and shall be made available to the preparing or acquiring activity upon request. The test circuit shall specify the inputs, outputs, biases, and power dissipation, as applicable, in accordance with the intent specified in test method 1005.
- b. T_A = +125°C, minimum.
- c. Test duration: 1,000 hours, except as permitted by method 1005 of MIL-STD-883.

4.4.2.2 Additional criteria for device classes Q and V. The steady-state life test duration, test condition and test temperature, or approved alternatives shall be as specified in the device manufacturer's QM plan in accordance with MIL-PRF-38535. The test circuit shall be maintained under document revision level control by the device manufacturer's TRB, in accordance with MIL-PRF-38535, and shall be made available to the acquiring or preparing activity upon request. The test circuit shall specify the inputs, outputs, biases, and power dissipation, as applicable, in accordance with the intent specified in test method 1005 of MIL-STD-883.

4.4.3 Group D inspection. The group D inspection end-point electrical parameters shall be as specified in table IIA herein.

4.4.4 Group E inspection. Group E inspection is required only for parts intended to be marked as radiation hardness assured (see 3.5 herein).

- a. End-point electrical parameters shall be as specified in table IIA herein.
- b. For device classes Q and V, the devices or test vehicle shall be subjected to radiation hardness assured tests as specified in MIL-PRF-38535 for the RHA level being tested. For device class M, the devices shall be subjected to radiation hardness assured tests as specified in MIL-PRF-38535, appendix A for the RHA level being tested. All device classes must meet the postirradiation end-point electrical parameter limits as defined in table I at T_A = +25°C ±5°C, after exposure, to the subgroups specified in table IIA herein.
- c. When specified in the purchase order or contract, a copy of the RHA delta limits shall be supplied.

4.4.4.1 Total dose irradiation testing. Total dose irradiation testing shall be performed in accordance with MIL-STD-883 method 1019 and as specified herein.

4.4.4.1.1 Accelerated aging test. Accelerated aging shall be performed on all devices requiring a RHA level greater than 5K rads(Si). The post-anneal end point electrical parameter limits shall be as specified in table IA herein and shall be the pre-irradiation end point electrical parameter limit at 25°C ±5°C. Testing shall be performed at initial qualification and after any design or process changes which may effect the RHA response of the device.

STANDARD MICROCIRCUIT DRAWING DEFENSE SUPPLY CENTER COLUMBUS COLUMBUS, OHIO 43216	SIZE A		5962-92153
		REVISION LEVEL K	SHEET 28

4.4.2 Single event phenomena (SEP) SEP testing shall be required on class V devices. SEP testing shall be performed on the SEC or alternate SEP test vehicle as approved by the qualifying activity at initial qualification and after any design or process changes which may affect the upset or latchup characteristics. Test four devices with zero failures. ASTM standard F1192 may be used as a guideline when performing SEP testing. The test conditions for SEP are as follows:

- a. The ion beam angle of incidence shall be normal to the die surface and 60 degrees to the normal, inclusive (i.e., $0^\circ < \text{angle} < 60^\circ$). No shadowing of the ion beam due to fixturing or package related effects is allowed.
- b. The fluence shall be greater than 100 errors or $> 10^7$ ions/cm².
- c. The flux shall be between 10^2 and 10^5 ion/cm²/s. The cross section shall be verified to be flux independent by measuring the cross section at two flux rates which differ by at least an order of magnitude.
- d. The particle range shall be > 20 microns in silicon.
- e. The test temperature shall be $+25^\circ\text{C}$ and the maximum rated operating temperature $\pm 10^\circ\text{C}$.
- f. Bias conditions shall be $V_{CC} = 4.5$ V dc for the upset measurements and $V_{CC} = 5.5$ V dc for the latchup measurements.
- g. For SEP test limits see table IB herein.

4.4.4.3 Additional information. When specified in the purchase order or contract, a copy of the following additional data shall be supplied.

- a. RHA upset levels.
- b. Test conditions (SEP).
- c. Number of upsets (SEP).
- d. Number of transients (SEP).
- e. Occurrence of latchup (SEP).

4.5 Delta measurements for device class V. Delta measurements, as specified in table IIA, shall be made and recorded before and after the required burn-in screens and steady-state life tests to determine delta compliance. The electrical parameters to be measured, with associated delta limits are listed in table IIB. The device manufacturer may, at his option, either perform delta measurements or within 24 hours after burn-in perform final electrical parameter tests, subgroups 1, 7, and 9.

5. PACKAGING

5.1 Packaging requirements. The requirements for packaging shall be in accordance with MIL-PRF-38535 for device classes Q and V or MIL-PRF-38535, appendix A for device class M.

6. NOTES

6.1 Intended use. Microcircuits conforming to this drawing are intended for use for Government microcircuit applications (original equipment), design applications, and logistics purposes.

6.1.1 Replaceability. Microcircuits covered by this drawing will replace the same generic device covered by a contractor-prepared specification or drawing.

6.1.2 Substitutability. Device class Q devices will replace device class M devices.

6.2 Configuration control of SMD's. All proposed changes to existing SMD's will be coordinated with the users of record for the individual documents. This coordination will be accomplished in accordance with MIL-STD-973 using DD Form 1692, Engineering Change Proposal.

6.3 Record of users. Military and industrial users should inform Defense Supply Center Columbus when a system application requires configuration control and which SMD's are applicable to that system. DSCC will maintain a record of users and this list will be used for coordination and distribution of changes to the drawings. Users of drawings covering microelectronic devices (FSC 5962) should contact DSCC-VA, telephone (614) 692-0525.

STANDARD MICROCIRCUIT DRAWING DEFENSE SUPPLY CENTER COLUMBUS COLUMBUS, OHIO 43216	SIZE A		5962-92153
		REVISION LEVEL K	SHEET 29

DSCC FORM 2234
APR 97

■ 9004708 0030830 2T0 ■

6.4 Comments. Comments on this drawing should be directed to DSCC-VA, Columbus, Ohio 43216-5000, or telephone (614) 692-0674.

6.5 Symbols, definitions, and functional descriptions. The abbreviations, symbols, and definitions used herein are defined in MIL-PRF-38535 and herein:

- C_{IN}, C_{OUT} ----- Input and bidirectional output capacitance, terminal-to-GND.
- GND ----- Ground zero voltage potential.
- I_{CC} ----- Supply current.
- I_{IL} ----- Input current low.
- I_{IH} ----- Input current high.
- T_C ----- Case temperature.
- T_A ----- Ambient temperature.
- V_{CC} ----- Positive supply voltage.
- O/V ----- Latch-up over-voltage.
- O/I ----- Latch-up over-current.

6.5.1 Timing limits. The table of timing values shows either a minimum or a maximum limit for each parameter. Input requirements are specified from the external system point of view. Thus, address setup time is shown as a minimum since the system must supply at least that much time (even though most devices do not require it). On the other hand, responses from the memory are specified from the device point of view. Thus, the access time is shown as a maximum since the device never provides data later than that time.

6.5.2 Waveforms.

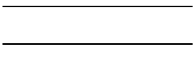
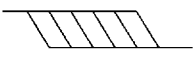
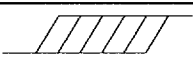
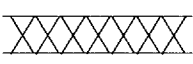
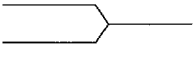
Waveform symbol	Input	Output
	MUST BE VALID	WILL BE VALID
	CHANGE FROM H TO L	WILL CHANGE FROM H TO L
	CHANGE FROM L TO H	WILL CHANGE FROM L TO H
	DON'T CARE ANY CHANGE PERMITTED	CHANGING STATE UNKNOWN
		HIGH IMPEDANCE

6.6 Sources of supply.

6.6.1 Sources of supply for device classes Q and V. Sources of supply for device classes Q and V are listed in QML-38535. The vendors listed in QML-38535 have submitted a certificate of compliance (see 3.6 herein) to DSCC-VA and have agreed to this drawing.

6.6.2 Approved sources of supply for device class M. Approved sources of supply for class M are listed in MIL-HDBK-103. The vendors listed in MIL-HDBK-103 have agreed to this drawing and a certificate of compliance (see 3.6 herein) has been submitted to and accepted by DSCC-VA.

STANDARD MICROCIRCUIT DRAWING DEFENSE SUPPLY CENTER COLUMBUS COLUMBUS, OHIO 43216	SIZE A		5962-92153
		REVISION LEVEL K	SHEET 30

DSCC FORM 2234
APR 97

9004708 0030831 137

FUNCTIONAL ALGORITHMS

10. SCOPE

10.1 Scope. Functional algorithms are test patterns which define the exact sequence of events used to verify proper operation of a random access memory (RAM). Each algorithm serves a specific purpose for the testing of the device. It is understood that all manufacturers do not have the same test equipment; therefore, it becomes the responsibility of each manufacturer to guarantee that the test patterns described herein are followed as closely as possible, or equivalent patterns be used that serve the same purpose. Each manufacturer should demonstrate that this condition will be met. Algorithms shall be applied to the device in a topologically pure fashion. This appendix is a mandatory part of the specification. The information contained herein is intended for compliance.

20. APPLICABLE DOCUMENTS. This section is not applicable to this appendix.

30. ALGORITHMS

30.1 Algorithm A (pattern 1).

30.1.1 Checkerboard, checkerboard-bar.

- Step 1. Load memory with a checkerboard data pattern by incrementing from location 0 to maximum.
- Step 2. Read memory, verifying the output checkerboard pattern by incrementing from location 0 to maximum.
- Step 3. Load memory with a checkerboard-bar pattern by incrementing from location 0 to maximum.
- Step 4. Read memory, verifying the output checkerboard-bar pattern by incrementing from location 0 to maximum.

30.2 Algorithm B (pattern 2).

30.2.1 March.

- Step 1. Load memory with background data, incrementing from minimum to maximum address locations (All "0's").
- Step 2. Read data in location 0.
- Step 3. Write complement data to location 0.
- Step 4. Read complement data in location 0.
- Step 5. Repeat steps 2 through 4 incrementing X-fast sequentially, for each location in the array.
- Step 6. Read complement data in maximum address location.
- Step 7. Write data to maximum address location.
- Step 8. Read data in maximum address location.
- Step 9. Repeat steps 6 through 8 decrementing X-fast sequentially for, each location in the array.
- Step 10. Read data in location 0.
- Step 11. Write complement data to location 0.
- Step 12. Read complement data in location 0.
- Step 13. Repeat steps 10 through 12 decrementing X-fast sequentially for each location in the array.
- Step 14. Read complement data in maximum address location.
- Step 15. Write data to maximum address location.
- Step 16. Read data in maximum address location.
- Step 17. Repeat steps 14 through 16 incrementing X-fast sequentially for each location in the array.
- Step 18. Read background data from memory, decrementing X-fast from maximum to minimum address locations.

30.3 Algorithm C (pattern 3).

30.2.1 XY March.

- Step 1. Load memory with background data, incrementing from minimum to maximum address locations (All "0's").
- Step 2. Read data in location 0.
- Step 3. Write complement data to location 0.
- Step 4. Read complement data in location 0.
- Step 5. Repeat steps 2 through 4 incrementing Y-fast sequentially, for each location in the array.
- Step 6. Read complement data in maximum address location.
- Step 7. Write data to maximum address location.
- Step 8. Read data in maximum address location.
- Step 9. Repeat steps 6 through 8 decrementing X-fast sequentially for each location in the array.
- Step 10. Read data in location 0.
- Step 11. Write complement data to location 0.

STANDARD MICROCIRCUIT DRAWING DEFENSE SUPPLY CENTER COLUMBUS COLUMBUS, OHIO 43216	SIZE A		5962-92153
		REVISION LEVEL K	SHEET 31

DSCC FORM 2234
APR 97

■ 9004708 0030832 073 ■

- Step 12. Read complement data in location 0.
- Step 13. Repeat steps 10 through 12 decrementing Y-fast sequentially for each location in the array.
- Step 14. Read complement data in maximum address location.
- Step 15. Write data to maximum address location.
- Step 16. Read data in maximum address location.
- Step 17. Repeat steps 14 through 16 incrementing X-fast sequentially for each location in the array.
- Step 18. Read background data from memory, decrementing Y-fast from maximum to minimum address locations.

30.4 Algorithm D (pattern 4).

30.4.1 CEDES - CE deselect checkerboard, checkerboard-bar.

- Step 1. Load memory with a checkerboard data pattern by incrementing from location 0 to maximum.
- Step 2. Deselect device, attempt to load memory with checkerboard-bar data pattern by incrementing from location 0 to maximum.
- Step 3. Read memory, verifying the output checkerboard pattern by incrementing from location 0 to maximum.
- Step 4. Load memory with a checkerboard-bar pattern by incrementing from location 0 to maximum.
- Step 5. Deselect device, attempt to load memory with checkerboard data pattern by incrementing from location 0 to maximum.
- Step 6. Read memory, verifying the output checkerboard-bar pattern by incrementing from location 0 to maximum.

STANDARD MICROCIRCUIT DRAWING DEFENSE SUPPLY CENTER COLUMBUS COLUMBUS, OHIO 43216	SIZE A		5962-92153
		REVISION LEVEL K	SHEET 32

DSCC FORM 2234
APR 97

■ 9004708 0030833 TOT ■

STANDARD MICROCIRCUIT DRAWING SOURCE APPROVAL BULLETIN

[查询"5962H9215301QNC"供应商](#)

DATE: 97-08-27

Approved sources of supply for SMD 5962-92153 are listed below for immediate acquisition only and shall be added to QML-38535 and MIL-HDBK-103 during the next revision. QML-38535 and MIL-HDBK-103 will be revised to include the addition or deletion of sources. The vendors listed below have agreed to this drawing and a certificate of compliance has been submitted to and accepted by DSSC-VA. This bulletin is superseded by the next dated revision of QML-38535 and MIL-HDBK-103.

Standard microcircuit drawing PIN 1/	Vendor CAGE number	Vendor similar PIN 2/
5962H9215301VXC	52088	LOR2568C-V60X
5962H9215301QXC	52088	LOR2568C-Q60X
5962H9215301VYC	52088	LOR2568C-V60Y
5962H9215301QYC	52088	LOR2568C-Q60Y
5962H9215301VNC	52088	LOR2568C-V60I
5962H9215301QNC	52088	LOR2568C-Q60I
5962H9215302VXC	52088	LOR2568T-V60X
5962H9215302QXC	52088	LOR2568T-Q60X
5962H9215302VYC	52088	LOR2568T-V60Y
5962H9215302QYC	52088	LOR2568T-Q60Y
5962H9215302VNC	52088	LOR2568T-V60I
5962H9215302QNC	52088	LOR2568T-Q60I
5962H9215303VXC	52088	LOR2568C-V40X
5962H9215303QXC	52088	LOR2568C-Q40X
5962H9215303VYC	52088	LOR2568C-V40Y
5962H9215303QYC	52088	LOR2568C-Q40Y
5962H9215303VNC	52088	LOR2568C-V40I
5962H9215303QNC	52088	LOR2568C-Q40I
5962H9215303VMA	65342	UT7156C40PCAH
5962H9215303QMA	65342	UT7156C40PCAH
5962H9215303VTA	65342	UT7156C40WCAH
5962H9215303QTA	65342	UT7156C40WCAH
5962H9215303VMC	65342	UT7156C40PCCH
5962H9215303QMC	65342	UT7156C40PCCH
5962H9215303VTC	65342	UT7156C40WCCH
5962H9215303QTC	65342	UT7156C40WCCH
5962H9215304VXC	52088	LOR2568T-V40X
5962H9215304QXC	52088	LOR2568T-Q40X
5962H9215304VYC	52088	LOR2568T-V40Y
5962H9215304QYC	52088	LOR2568T-Q40Y
5962H9215304VNC	52088	LOR2568T-V40I
5962H9215304QNC	52088	LOR2568T-Q40I

See footnotes at end of list.

■ 9004708 0030834 946 ■

[查询"5962H9215301QNC"供应商](#)

Standard microcircuit drawing PIN 1/	Vendor CAGE number	Vendor similar PIN 2/
5962H9215305VZC	34168	HC6856/1XVHZC
5962R9215305VZC	34168	HC6856/1XVRZC
5962H9215305QZC	34168	HC6856/1XQHZC
5962R9215305QZC	34168	HC6856/1XQRZC
5962H9215305VUC	34168	HC6856/1WVHZC
5962R9215305VUC	34168	HC6856/1WVRZC
5962H9215305QUC	34168	HC6856/1WQHZC
5962R9215305QUC	34168	HC6856/1WQRZC
5962H9215305VMC	34168	HC6856/1RVHZC
5962H9215305QMC	34168	HC6856/1RQHZC
5962H9215305V9C	34168	HC6856/1NVHZC
5962H9215305Q9C	34168	HC6856/1NQHZC
5962R9215305V4C	34168	HC6856/2XVRZC
5962H9215305V4C	34168	HC6856/2XVHZC
5962R9215305Q4C	34168	HC6856/2XQRZC
5962H9215305Q4C	34168	HC6856/2XQHZC
5962H9215306VZC	34168	HC6856/1XVHZT
5962R9215306VZC	34168	HC6856/1XVRZT
5962H9215306QZC	34168	HC6856/1XQHZT
5962R9215306QZC	34168	HC6856/1XQRZT
5962H9215306VUC	34168	HC6856/1WVHZT
5962R9215306VUC	34168	HC6856/1WVRZT
5962H9215306QUC	34168	HC6856/1WQHZT
5962R9215306QUC	34168	HC6856/1WQRZT
5962H9215306VMC	34168	HC6856/1RVHZT
5962H9215306QMC	34168	HC6856/1RQHZT
5962H9215306V9C	34168	HC6856/1NVHZT
5962H9215306Q9C	34168	HC6856/1NQHZT
5962H9215307VZC	34168	HC6856/1XVHAC
5962R9215307VZC	34168	HC6856/1XVRAC
5962H9215307QZC	34168	HC6856/1XQHAC
5962R9215307QZC	34168	HC6856/1XQRAC
5962H9215307VUC	34168	HC6856/1WVHAC
5962R9215307VUC	34168	HC6856/1WVRAC
5962H9215307QUC	34168	HC6856/1WQHAC
5962R9215307QUC	34168	HC6856/1WQRAC
5962H9215307VMC	34168	HC6856/1RVHAC
5962H9215307QMC	34168	HC6856/1RQHAC
5962H9215307V9C	34168	HC6856/1NVHAC
5962H9215307Q9C	34168	HC6856/1NQHAC

See footnotes at end of table.

■ 9004708 0030835 882 ■

[查询"5962H9215301QNC"供应商](#)

Standard microcircuit drawing PIN <u>1/</u>	Vendor CAGE number	Vendor similar PIN <u>2/</u>
5962R9215307V4C	34168	HC6856/2XVRAC
5962H9215307V4C	34168	HC6856/2XVHAC
5962R9215307Q4C	34168	HC6856/2XQRAC
5962H9215307Q4C	34168	HC6856/2XQHAC
5962H9215308VZC	34168	HC6856/1XVHAT
5962R9215308VZC	34168	HC6856/1XVRAT
5962H9215308QZC	34168	HC6856/1XQHAT
5962R9215308QZC	34168	HC6856/1XQRAT
5962H9215308VUC	34168	HC6856/1WVHAT
5962R9215308VUC	34168	HC6856/1WVRAT
5962H9215308QUC	34168	HC6856/1WQHAT
5962R9215308QUC	34168	HC6856/1WQRAT
5962H9215308VMC	34168	HC6856/1RVHAT
5962H9215308QMC	34168	HC6856/1RQHAT
5962H9215308V9C	34168	HC6856/1NVHAT
5962H9215308Q9C	34168	HC6856/1NQHAT
5962R9215309QMA	65342	UT7156C55PBAR
5962H9215309QMA	65342	UT7156C55PBAH
5962R9215309QMC	65342	UT7156C55PBCR
5962H9215309QMC	65342	UT7156C55PBCH
5962R9215310QMA	65342	UT7156T55PBAR
5962H9215310QMA	65342	UT7156T55PBAH
5962R9215310QMC	65342	UT7156T55PBCR
5962H9215310QMC	65342	UT7156T55PBCH
5962R9215311QTA	65342	UT7156C55WBAR
5962H9215311QTA	65342	UT7156C55WBAH
5962R9215311QTC	65342	UT7156C55WBCR
5962H9215311QTC	65342	UT7156C55WBCH
5962R9215312QTA	65342	UT7156T55WBAR
5962H9215312QTA	65342	UT7156T55WBAH
5962R9215312QTC	65342	UT7156T55WBCR
5962H9215312QTC	65342	UT7156T55WBCH
5962H9215313VXC	52088	LOR2568C-V30X
5962H9215313QXC	52088	LOR2568C-Q30X
5962H9215313VYC	52088	LOR2568C-V30Y
5962H9215313QYC	52088	LOR2568C-Q30Y
5962H9215313VNC	52088	LOR2568C-V30I
5962H9215313QNC	52088	LOR2568C-Q30I

See footnotes at end of table.

■ 9004708 0030836 719 ■

[查询"5962H9215301QNC"供应商](#)

Standard microcircuit drawing PIN ^{1/}	Vendor CAGE number	Vendor similar PIN ^{2/}
5962H9215314VXC	52088	LOR2568T-V30X
5962H9215314QXC	52088	LOR2568T-Q30X
5962H9215314VYC	52088	LOR2568T-V30Y
5962H9215314QYC	52088	LOR2568T-Q30Y
5962H9215314VNC	52088	LOR2568T-V30I
5962H9215314QNC	52088	LOR2568T-Q30I
5962R9215315QMA	65342	UT7156C70PBAR
5962R9215315QMC	65342	UT7156C70PBCR
5962R9215316QMA	65342	UT7156T70PBAR
5962R9215316QMC	65342	UT7156T70PBCR
5962R9215317QTA	65342	UT7156C70WBAR
5962R9215317QTC	65342	UT7156C70WBCR
5962R9215318QTA	65342	UT7156T70WBAR
5962R9215318QTC	65342	UT7156T70WBCR
5962H9215319VZC	34168	HC6856/1XVHCC
5962H9215319QZC	34168	HC6856/1XQHCC

^{1/} The lead finish shown for each PIN representing a hermetic package is the most readily available from the manufacturer listed for that part. If the desired lead finish is not listed, contact the Vendor to determine its availability.

^{2/} Caution. Do not use this number for item acquisition. Items acquired to this number may not satisfy the performance requirements of this drawing.

^{3/} Not available from an approved source of supply at this time.

Vendor CAGE
number

Vendor name
and address

52088

Lockheed Martin Federal Systems
9500 Godwin Drive
Manassas, VA 22110-4104

34168

Honeywell Inc.
Solid State Electronics Center
12001 State Hwy 55
Plymouth, MN 55441

65342

United Technologies Microelectronics Center
1575 Garden of Gods Road
Colorado Springs, CO 80907-3486

The information contained herein is disseminated for convenience only and the Government assumes no liability whatsoever for any inaccuracies in this information bulletin.