

High voltage, high current Darlington transistor array

[查询"BA12001"供应商](#)

BA12001B/BA12002/BA12003B/BA12003BF/ BA12004B

The BA12001B, BA12002, BA12003B, BA12003BF, and BA12004B are high current transistor arrays featuring high voltage withstand resistance and consisting of seven circuits of Darlington transistors.

Because it incorporates built-in surge-absorbing diodes and base current-control resistors needed when using inductive loads such as relay coils, attachments can be kept to a minimum.

With an output withstanding voltage as high as 60V (BA12001B, BA12003B, BA12003BF, and BA12004B) and an output current (sink current) of 500mA, this product is ideal for use with various drivers and as an interface with other elements.

●Applications

Drivers for LEDs, lamps, relays and solenoids

Interface with other elements

●Features

- 1) High output current. ($I_{OUT} = 500\text{mA max.}$)
- 2) High output voltage withstand resistance. ($V_{OUT} = 50\text{V max.}$)
- 3) Seven Darlington transistors built in.
- 4) Equipped with output surge-absorbing clamp diode.

●Block diagram

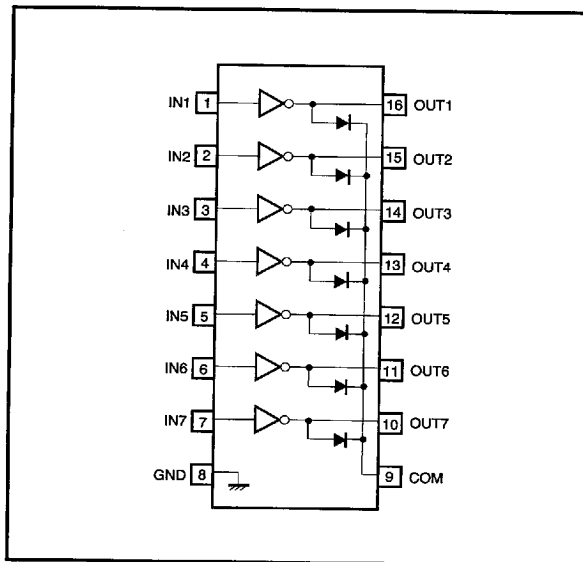

7828999 0021505 100

ROHM

●Internal circuit configuration diagram

[查询“BA12001”供应商](#)

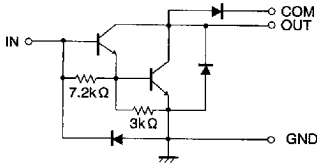

Fig.1 BA12001B

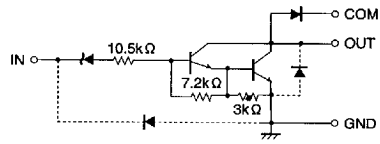

Fig.2 BA12002

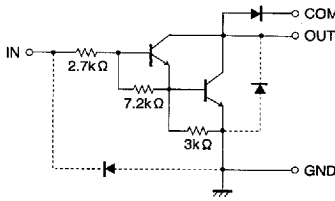

Fig.3 BA12003B / BF

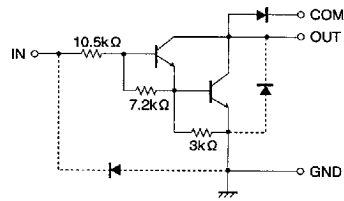

Fig.4 BA12004B

●Absolute maximum ratings (Ta=25°C)

Parameter		Symbol	Limits	Unit
Power supply voltage	other than BA12002	V _{CE}	60	V
	BA12002		50	
Input voltage	other than BA12001B	V _{IN}	-0.5~30	V
Input current	BA12001B	I _{IN}	25	mA / unit
Output current		I _{OUT}	500	mA / unit
Ground pin current		I _{GND}	2.3 *1	A
Power dissipation	DIP package	P _d	1250 *2	mW
	SOP package		625 *3	
Diode reverse voltage		V _R	60	V
Diode forward current		I _F	500	mA
Operating temperature		T _{opr}	-25~75	°C
Storage temperature		T _{stg}	-55~150	°C

*1 Pulse width ≤ 20 ms, duty cycle ≤ 10%, same current for all 7 circuits

*2 Reduced by 10 mW for each increase in Ta of 1°C over 25°C .

*3 Reduced by 50 mW for each increase in Ta of 1°C over 25°C .

7828999 0021506 047



● Recommended operating conditions (Ta=25°C)

Parameter	Symbol	Min.	Typ.	Max.	Unit	Conditions	
Output current	I _{OUT}	—	—	350	mA	Fig.8, 9	
Power supply voltage	V _{CE}	Other than BA12002	—	—	55	V	—
		BA12002	—	—	50	V	—
Input voltage (excluding BA12001B)	V _{IN}	—	—	30	V	—	
Input current (BA12001B only)	I _{IN}	—	—	25	mA / unit	—	

● Electrical characteristics (unless otherwise noted, Ta=25°C)

Parameter	Symbol	Min.	Typ.	Max.	Unit	Conditions	Measurement Circuit	
Output leakage current	I _L	—	0	10	μA	V _{CE} =50V	Fig.4	
DC current gain	h _{FE}	1000	2400	—	V	V _{CE} =2V, I _{OUT} =350mA	Fig.4	
Output saturation voltage	V _{CE(sat)}	—	0.94	1.1	V	I _{OUT} =100mA, I _{IN} =250 μA	Fig.4	
			1.14	1.3		I _{OUT} =200mA, I _{IN} =350 μA	Fig.4	
			1.46	1.6		I _{OUT} =350mA, I _{IN} =500 μA	Fig.4	
Input voltage	BA12002	V _{IN}	—	10.2	11	V	V _{CE} =2V, I _{OUT} =100mA	Fig.4
	BA12003B/BF			1.75	2			
	BA12004B			2.53	5			
	BA12002	V _{IN}	—	10.4	12	V	V _{CE} =2V, I _{OUT} =200mA	Fig.4
	BA12003B/BF			1.91	2.4			
	BA12004B			2.75	6			
	BA12002	V _{IN}	—	10.7	13.5	V	V _{CE} =2V, I _{OUT} =350mA	Fig.4
	BA12003B/BF			2.17	3.4			
BA12004B	3.27			8				
Input current	BA12002	I _{IN}	—	0.88	1.3	mA	V _{IN} =17V	Fig.4
	BA12003B/BF			0.90	1.35		V _{IN} =3.85V	
	BA12004B			0.39	0.5		V _{IN} =5V	
Diode reverse current	I _R	—	0	50	μA	V _R =50V	Fig.4	
Diode forward voltage	V _F	—	1.73	2	V	I _F =350mA	Fig.4	
Input capacitance	C _{IN}	—	30	—	pF	V _{IN} =0V, f=1MHz	Fig.4	

Note: Input voltage and input current for BA12001 vary based on external resistor.

7828999 0021507 T83

● Measurement circuits

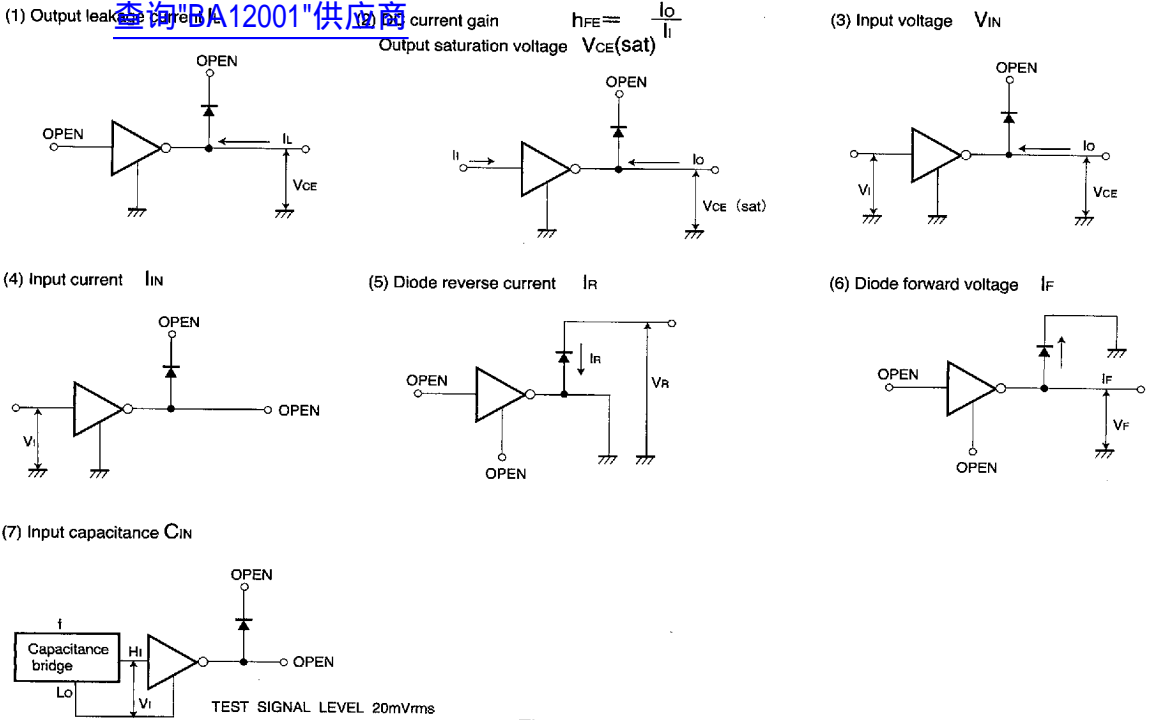

Fig. 4

● Application example

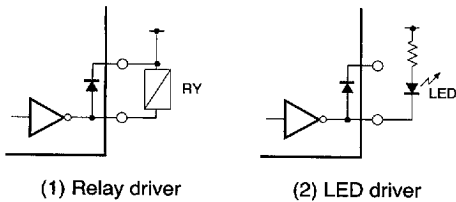

Fig. 5

● Reference items when using in application

The BA12001B is a transistor array which can be directly coupled to a general logic circuit such as PMOS, CMOS, or TTL.

Because the base current is limited to 25mA, a current limiting resistor needs to be connected in series with the input.

The BA12002 is designed for direct coupling with a 14 to 25V system PMOS. In order to limit the input current, a level shift diode (7V) and resistor are connected in series to each of the inputs.

The BA12003B/BF can be coupled directly to TTL or CMOS output (when operating at 5V). In order to limit the input current to a stable value, resistors are connected in series to each of the inputs.

The BA12004B is designed for direct coupling to CMOS or PMOS output using a 6 to 15V power supply voltage. In order to limit the input current to a stable value, resistors are connected in series to each of the inputs.

The load for each of these products should be connected between the driver output and the power supply. To protect the IC from excessive swing voltage, the COM pin (Pin 9) should be connected to the power supply.

7828999 0021508 91T

ROHM

●Electrical characteristic curves

查询"BA12001"供应商

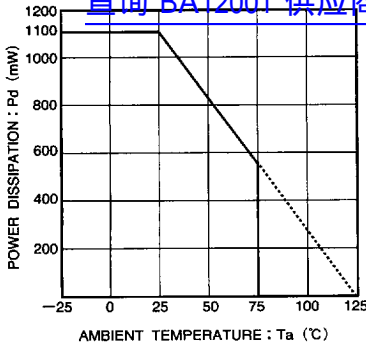

Fig. 6 Power dissipation - ambient temperature characteristic

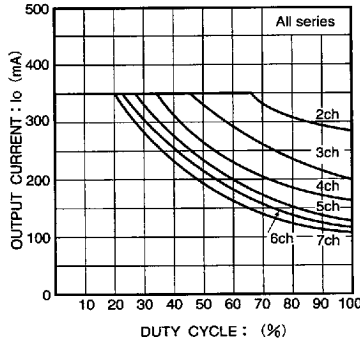

Fig. 7 Output conditions (1)

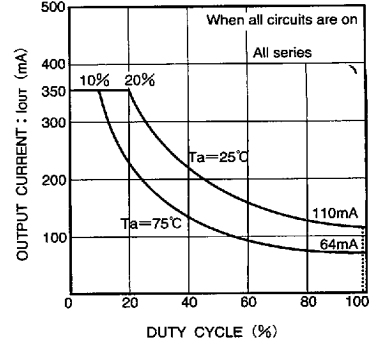

Fig. 8 Output conditions (2)

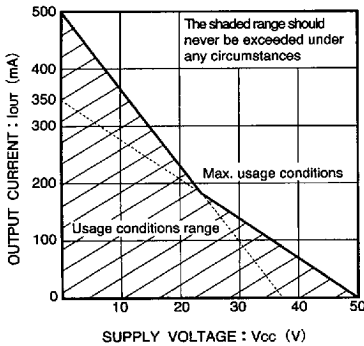

Fig. 9 Usage conditions range per circuit

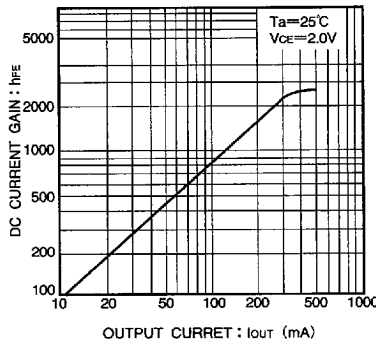

Fig. 10 DC current gain-output current characteristic

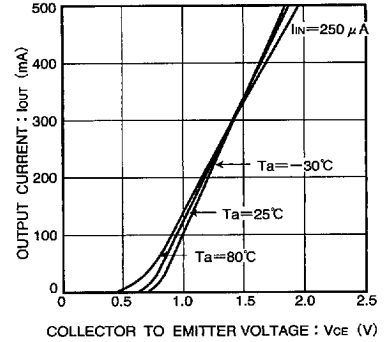

Fig. 11 Output current - voltage characteristic between collector and emitter

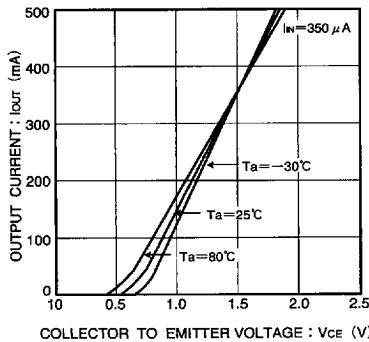

Fig. 12 Output current - voltage characteristic between collector and emitter

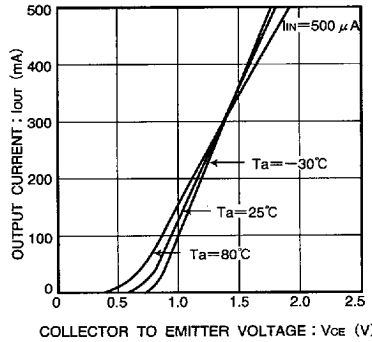

Fig. 13 Output current - voltage characteristic between collector and emitter

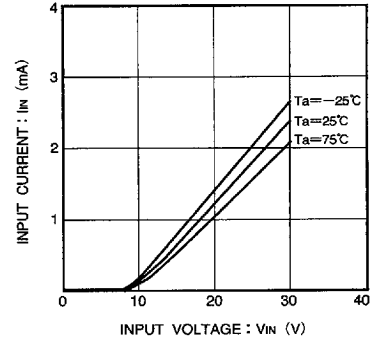

Figure 14 Input current - input voltage characteristic (BA12002)

7828999 0021509 856

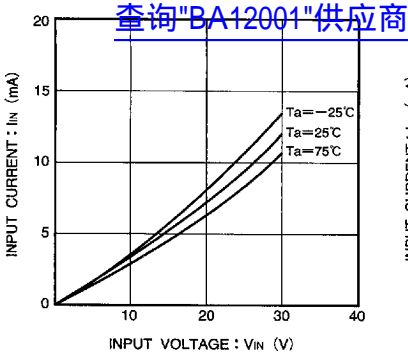

Fig. 15 Input current - input voltage characteristic (BA12003B/BF)

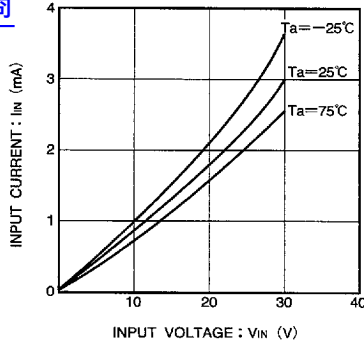

Fig. 16 Input current - input voltage characteristic (BA12004B)

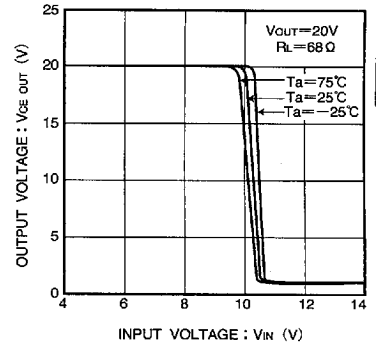

Fig.17 Output current - input voltage characteristics (BA12002)

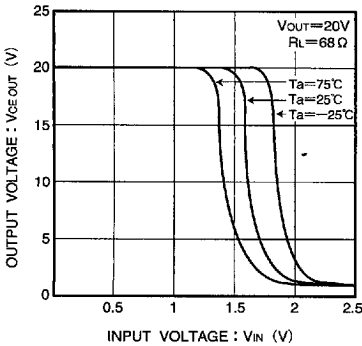

Fig. 18 Output voltage - input voltage characteristic (BA12003B/BF)

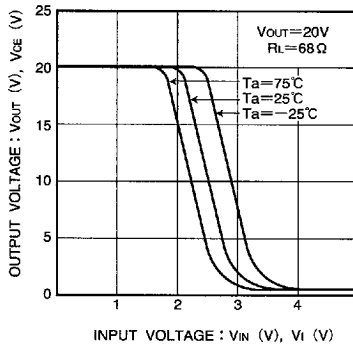
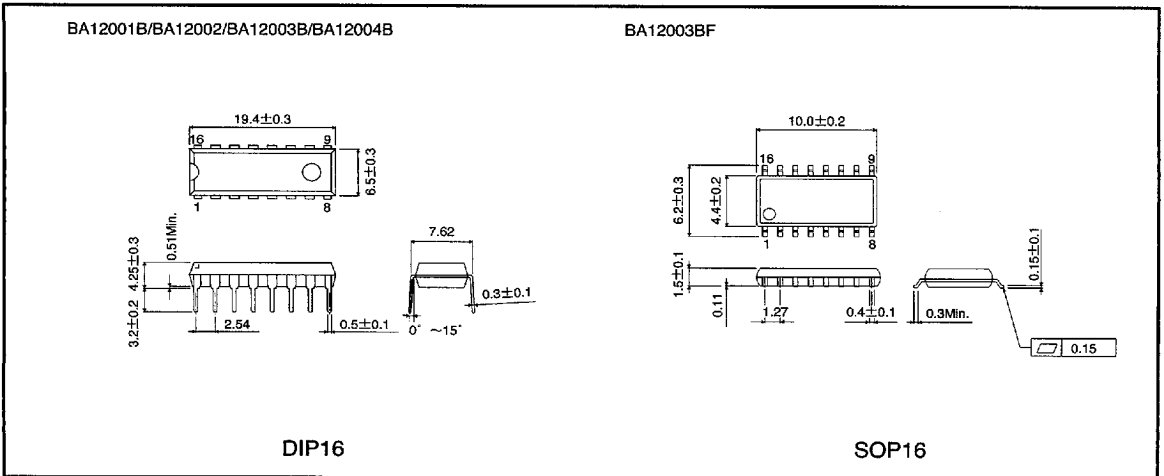

Fig. 19 Output voltage - input voltage characteristic (BA12004B)

● External dimensions (Units: mm)



7828999 0021510 578

