

200V, 3A Schottky Fast Soft-Recovery Power Rectifier

SMC Power Surface Mount Package

Features

- Lower Forward Voltage than any Ultrafast Rectifier:
 $V_F < 0.59 \text{ V}$ at 150°C
- Fast Switching Speed: Reverse Recovery Time (t_{RR}) $< 35 \text{ ns}$
- Soft Recovery Characteristics: Softness Factor (t_b/t_a) ≥ 1
- Highly Stable Over Temperature

Benefits

- Significantly Reduced EMI
- Eliminates the Need of Snubber Circuits
- Low Switching and Heat Losses
- Improved Thermal Management

Applications

- Engine and Convenience Control Systems
- Motor Controls
- Battery Chargers and Switching Power Supplies

Mechanical Characteristics

- Small Compact Surface Mount Package with J-Bend Leads
- Rectangular Package for Automated Handling
- Weight: 217 mg (Approximately)
- Finish: All External Surfaces Corrosion Resistant and Terminal Leads are Readily Solderable
- Lead and Mounting Surface Temperature for Soldering Purposes: 260°C Maximum for 10 Seconds
- Polarity: Notch in Plastic Body Indicates Cathode Lead

MAXIMUM RATINGS

Characteristic	Symbol	Value	Unit
Peak Repetitive Reverse Voltage Working Peak Reverse Voltage DC Blocking Voltage	V_{RRM} V_{RWM} V_R	200	V
Average Rectified Forward Current (Rated V_R , $T_C = \text{TBD}$)	$I_{F(AV)}$	3	A
Nonrepetitive Peak Surge Current	I_{FSM}	100	A
Operating Junction Temperature	T_J	-55 to +150	$^\circ\text{C}$

Maximum ratings are those values beyond which device damage can occur. Maximum ratings applied to the device are individual stress limit values (not normal operating conditions) and are not valid simultaneously. If these limits are exceeded, device functional operation is not implied, damage may occur and reliability may be affected.



ON Semiconductor®

<http://onsemi.com>

SCHOTTKY RECTIFIER
3 AMPS, 200 VOLTS

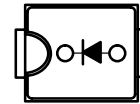

MARKING DIAGRAM



SMC
CASE 403

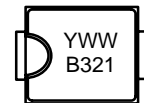

B321 = Specific Device Code
Y = Year
WW = Work Week

ORDERING INFORMATION

Device	Package	Shipping
MBRS3201T3	SMC	2500 / Tape & Reel

†For information on tape and reel specifications, including part orientation and tape sizes, please refer to our Tape and Reel Packaging Specification Brochure, BRD8011/D.

MBRS3201T3

THERMAL CHARACTERISTICS

Characteristic	Symbol	Value	Unit
Thermal Resistance – Junction-to-Lead	$R_{\theta JL}$	12	$^{\circ}C/W$
Thermal Resistance – Junction-to-Ambient	$R_{\theta JA}$	60	$^{\circ}C/W$

ELECTRICAL CHARACTERISTICS

Characteristic	Symbol	Value	Unit
Maximum Instantaneous Forward Voltage ($I_F = 3\text{ A}$, $T_J = 25^{\circ}C$) ($I_F = 3\text{ A}$, $T_J = 150^{\circ}C$)	V_F	0.84 0.59	V
Maximum Instantaneous Reverse Current (Rated V_R) (Rated DC Voltage, $T_J = 25^{\circ}C$) (Rated DC Voltage, $T_J = 150^{\circ}C$)	I_R	5 5	μA mA
Maximum Reverse Recovery Time ($I_F = 1\text{ A}$, $di/dt = 100\text{ A/us}$, $V_R = 30\text{ V}$)	t_{rr}	35	ns

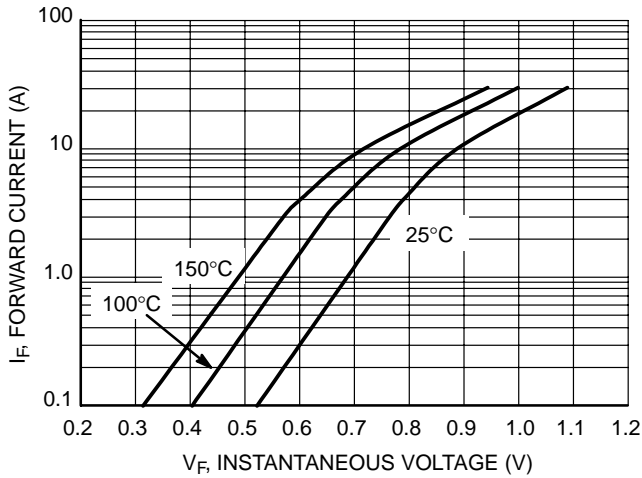

Figure 1. Typical Forward Voltage

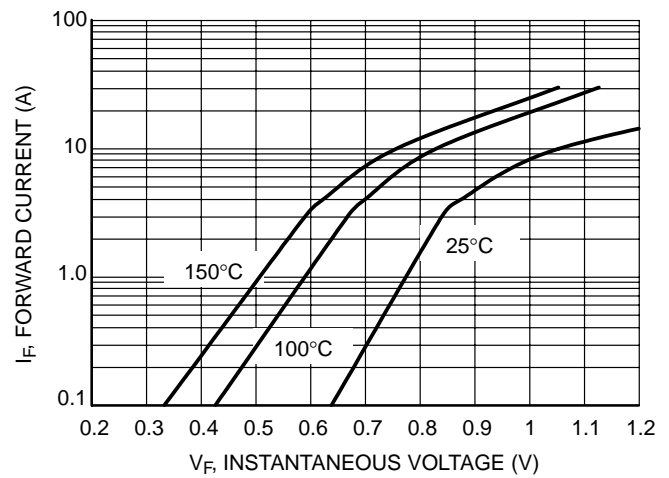

Figure 2. Maximum Forward Voltage

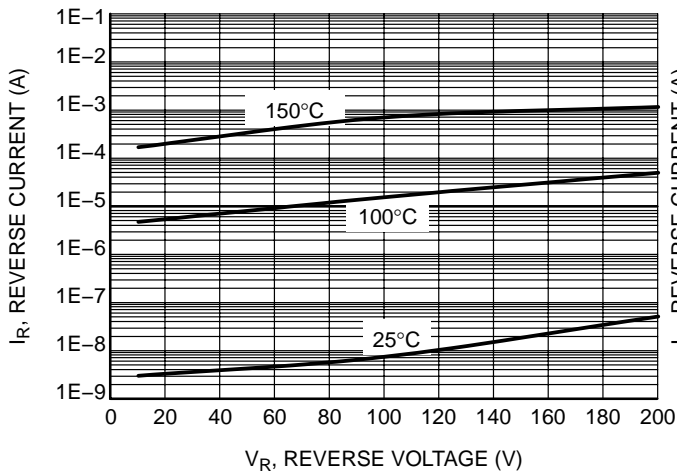

Figure 3. Typical Reverse Voltage

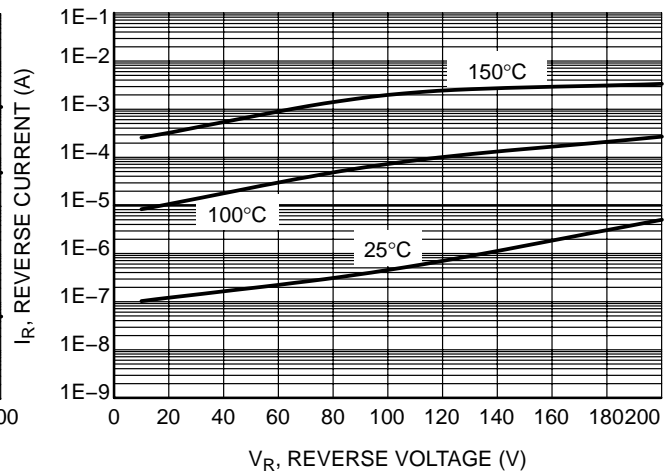

Figure 4. Maximum Reverse Voltage

MBRS3201T3

[查询"MBRS3201T3G"供应商](#)

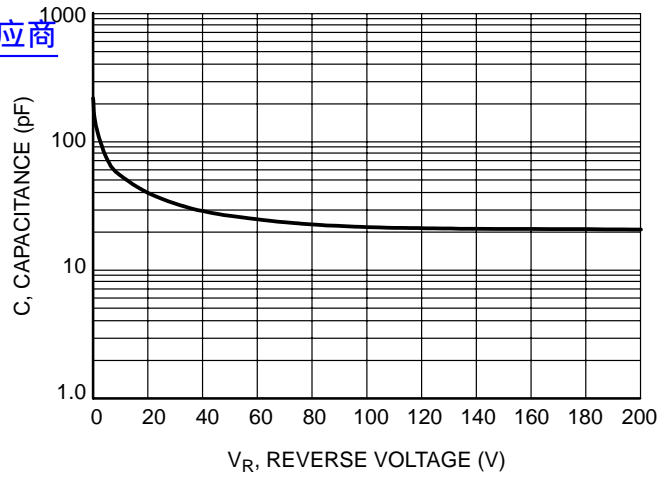

Figure 5. Typical Capacitance

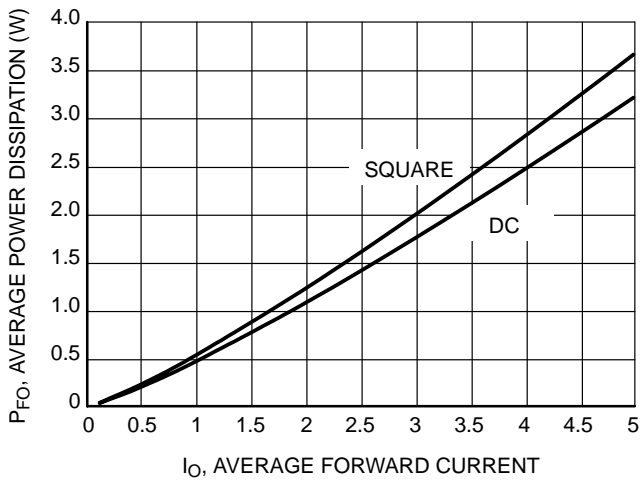

Figure 6. Power Dissipation

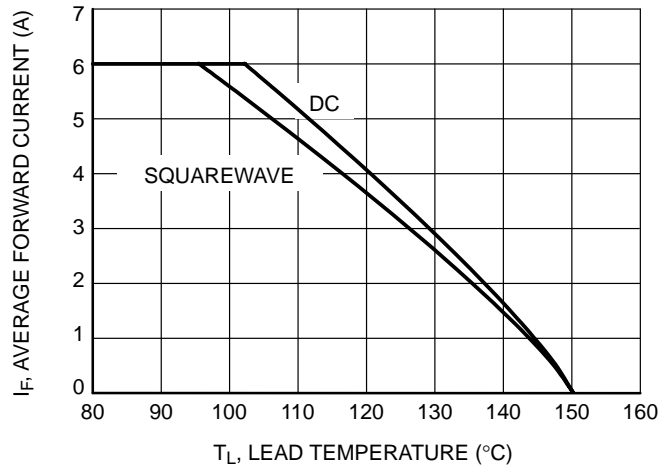

Figure 7. Derating Curve

MBRS3201T3

[查询"MBRS3201T3G"供应商](#)

PACKAGE DIMENSIONS

SMC
CASE 403-03
ISSUE D

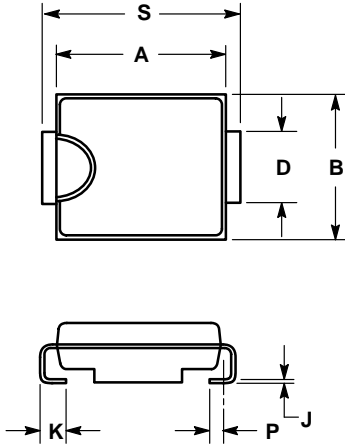

NOTES:

1. DIMENSIONING AND TOLERANCING PER ANSI Y14.5M, 1982.
2. CONTROLLING DIMENSION: INCH.
3. D DIMENSION SHALL BE MEASURED WITHIN DIMENSION P.
4. 403-01 THRU -02 OBSOLETE, NEW STANDARD 403-03.

DIM	INCHES		MILLIMETERS	
	MIN	MAX	MIN	MAX
A	0.260	0.280	6.60	7.11
B	0.220	0.240	5.59	6.10
C	0.075	0.095	1.90	2.41
D	0.115	0.121	2.92	3.07
H	0.0020	0.0060	0.051	0.152
J	0.006	0.012	0.15	0.30
K	0.030	0.050	0.76	1.27
P	0.020 REF		0.51 REF	
S	0.305	0.320	7.75	8.13

ON Semiconductor and  are registered trademarks of Semiconductor Components Industries, LLC (SCILLC). SCILLC reserves the right to make changes without further notice to any products herein. SCILLC makes no warranty, representation or guarantee regarding the suitability of its products for any particular purpose, nor does SCILLC assume any liability arising out of the application or use of any product or circuit, and specifically disclaims any and all liability, including without limitation special, consequential or incidental damages. "Typical" parameters which may be provided in SCILLC data sheets and/or specifications can and do vary in different applications and actual performance may vary over time. All operating parameters, including "Typicals" must be validated for each customer application by customer's technical experts. SCILLC does not convey any license under its patent rights nor the rights of others. SCILLC products are not designed, intended, or authorized for use as components in systems intended for surgical implant into the body, or other applications intended to support or sustain life, or for any other application in which the failure of the SCILLC product could create a situation where personal injury or death may occur. Should Buyer purchase or use SCILLC products for any such unintended or unauthorized application, Buyer shall indemnify and hold SCILLC and its officers, employees, subsidiaries, affiliates, and distributors harmless against all claims, costs, damages, and expenses, and reasonable attorney fees arising out of, directly or indirectly, any claim of personal injury or death associated with such unintended or unauthorized use, even if such claim alleges that SCILLC was negligent regarding the design or manufacture of the part. SCILLC is an Equal Opportunity/Affirmative Action Employer. This literature is subject to all applicable copyright laws and is not for resale in any manner.

PUBLICATION ORDERING INFORMATION

LITERATURE FULFILLMENT:

Literature Distribution Center for ON Semiconductor
P.O. Box 61312, Phoenix, Arizona 85082-1312 USA
Phone: 480-829-7710 or 800-344-3860 Toll Free USA/Canada
Fax: 480-829-7709 or 800-344-3867 Toll Free USA/Canada
Email: orderlit@onsemi.com

N. American Technical Support: 800-282-9855 Toll Free
USA/Canada

Japan: ON Semiconductor, Japan Customer Focus Center
2-9-1 Kamimeguro, Meguro-ku, Tokyo, Japan 153-0051
Phone: 81-3-5773-3850

ON Semiconductor Website: <http://onsemi.com>

Order Literature: <http://www.onsemi.com/litorder>

For additional information, please contact your
local Sales Representative.

MBRS3201T3/D