

Surface Mount Full Color PLCC LEDs

MSL-204RGBAH

Description

The MSL-204RGBAH, a full colors device, is made with InGaN (on Sapphire substrate) BLUE, GREEN and AlInGaP RED LED dice. It is PLCC package, suitable for all SMT assembly methods.

Package Dimensions

Unit: mm (inches)

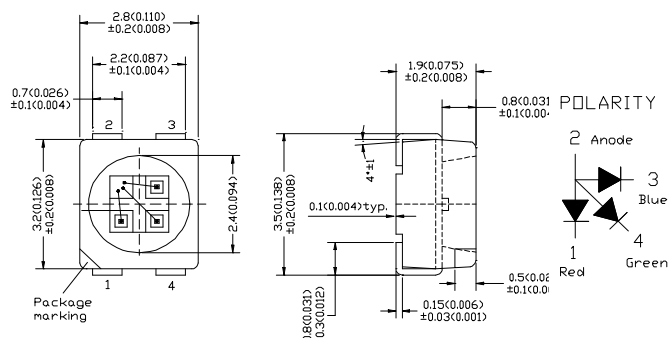

Application

- Key pad backlighting
- Symbol backlighting
- Front panel indicator
- Indoor full color sign board

Recommand Solder Pad

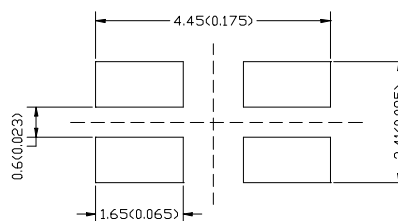

- Notes :
1. All dimensions are in millimeters.
 2. Tolerance is ± 0.20 mm unless otherwise noted.

Absolute Maximum Ratings

@ T_A=25°C

Parameter	Symbol	Maximum Rating	Unit
Peak Forward Current(1/10 Duty Cycle@1KHz)	I _{FP}	100	mA
Continuous Forward Current	I _F	30	mA
Reverse Voltage	V _R	5	V
Operating Temperature Range	T _{opr}	-20°C to +80°C	
Storage Temperature Range	T _{stg}	-30°C to +100°C	
Electrostatic Discharge Threshold	E _{ot}	300	V

Optical-Electrical Characteristics

Blue

@ T_A=25°C

Parameter	Test Conditions	Symbol	Min .	Typ .	Max .	Unit .
Luminous Intensity	I _F =20mA	I _V	-	80	-	mcd
Forward Voltage	I _F =20mA	V _F	-	3.5	4.2	V
Reverse Current	V _R =5V	I _R	-	-	100	μA
Peak/Dominant Wavelength	I _F =20mA	λ _d	-	470	-	nm
Spectral Linewidth	I _F =20mA	Δλ	-	26	-	nm
Viewing Angle	I _F =20mA	2θ _{1/2}	-	120	-	deg.

Green

@ T_A=25°C

Parameter	Test Conditions	Symbol	Min .	Typ .	Max .	Unit .
Luminous Intensity	I _F =20mA	I _V	-	280	-	mcd
Forward Voltage	I _F =20mA	V _F	-	3.5	4.2	V
Reverse Current	V _R =5V	I _R	-	-	100	μA
Peak/Dominant Wavelength	I _F =20mA	λ _d	-	525	-	nm
Spectral Linewidth	I _F =20mA	Δλ	-	35	-	nm
Viewing Angle	I _F =20mA	2θ _{1/2}	-	120	-	deg.

Red

@ T_A=25°C

Parameter	Test Conditions	Symbol	Min .	Typ .	Max .	Unit .
Luminous Intensity	I _F =20mA	I _V	-	130	-	mcd
Forward Voltage	I _F =20mA	V _F	-	2.1	2.6	V
Reverse Current	V _R =5V	I _R	-	-	10	μA
Peak/Dominant Wavelength	I _F =20mA	λ _d	-	625	-	nm
Spectral Linewidth	I _F =20mA	Δλ	-	20	-	nm
Viewing Angle	I _F =20mA	2θ _{1/2}	-	120	-	deg.

Typical Optical-Electrical Characteristic Curves

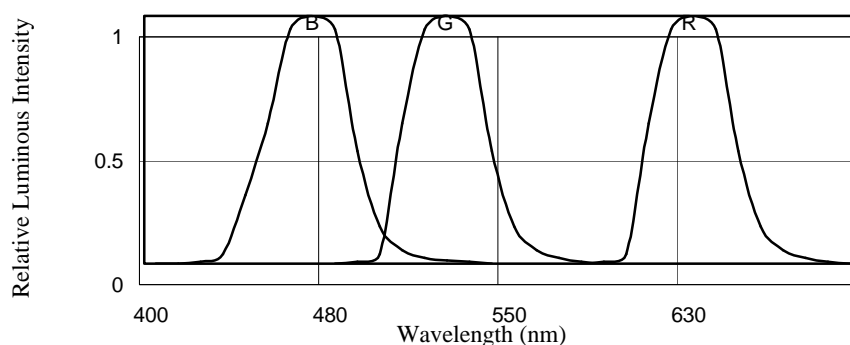

FIG.1 RELATIVE INTENSITY LUMINOUS VS. WAVELENGTH

Typical Optical-Electrical Characteristic Curves

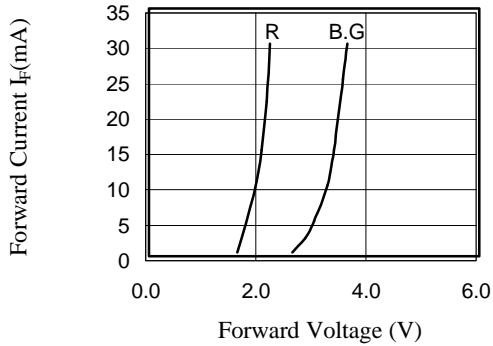

FIG.2 FORWARD CURRENT VS. FORWARD VOLTAGE

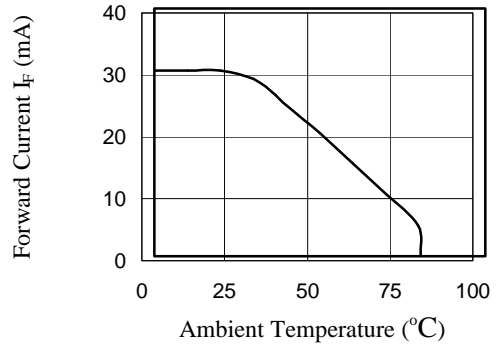

FIG.3 FORWARD CURRENT VS. AMBIENT TEMPERATURE

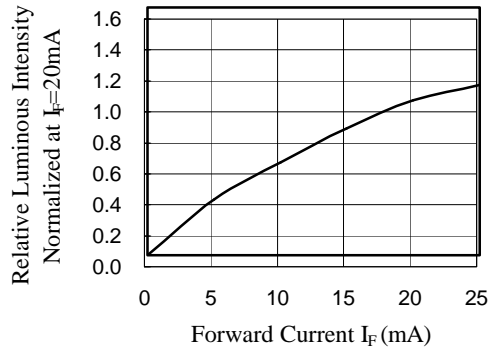

FIG.4 RELATIVE LUMINOUS INTENSITY VS. FORWARD CURRENT

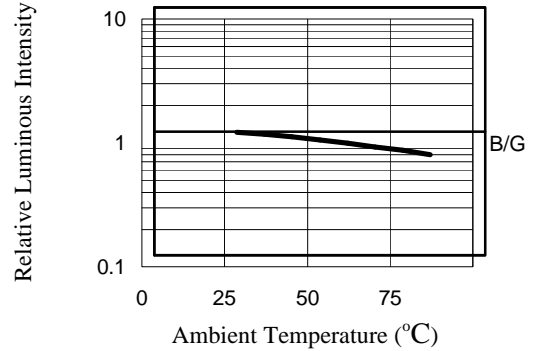

FIG.5-2 RELATIVE LUMINOUS INTENSITY VS. AMBIENT TEMPERATURE

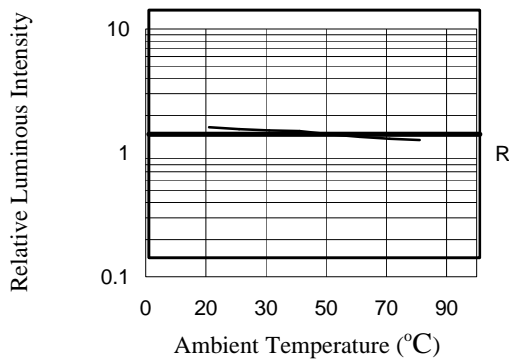

FIG.5-3 RELATIVE LUMINOUS INTENSITY VS. AMBIENT TEMPERATURE

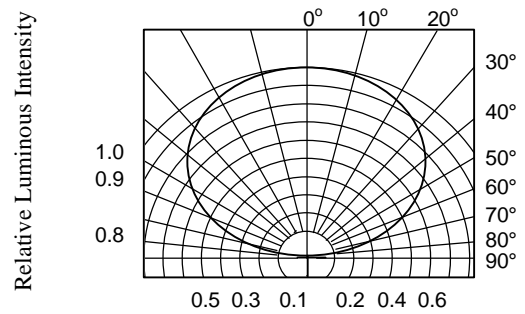

FIG.6 RADIATION DIAGRAM