

Buffered H-Bridge

FEATURES

- 0.65-A H-Bridge
- 200-kHz Switching Rate
- Shoot-Through Limited
- TTL Compatible Inputs
- 3.8- to 13.2-V Operating Range
- Surface Mount Packaging
- Total $r_{DS(on)}$ for N- and P-Channel:
1.8 Ω @ $V_{DD} = 4.5\text{ V}$ and $T_A = 85^\circ\text{C}$

APPLICATIONS

- VCM Driver
- Brushed Motor Driver
- Stepper Motor Driver
- Power Converter
- Optical Disk Drives
- Power Supplies
- High Performance Servo

DESCRIPTION

The Si9988 is an integrated, buffered H-bridge with TTL compatible inputs and the capability of delivering a continuous 0.65 A @ $V_{DD} = 5\text{ V}$ (room temperature) at switching rates up to 200 kHz. Internal logic prevents the upper and lower outputs of either half-bridge from being turned on simultaneously. Both outputs may be forced low (for motor braking) by pulling EN to logic high.

The Si9988 is available in both standard and lead (Pb)-free, 8-pin TSSOP packages, specified to operate over a voltage range of 3.8 V to 13.2 V, and the industrial temperature range of -40 to 85°C (D suffix).

FUNCTIONAL BLOCK DIAGRAM, PIN CONFIGURATION AND TRUTH TABLE

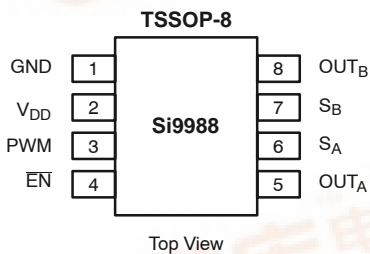

TRUTH TABLE			
EN	PWM	OUT _A	OUT _B
0	0	0	1
0	1	1	0
1	0	0	0
1	1	0	0

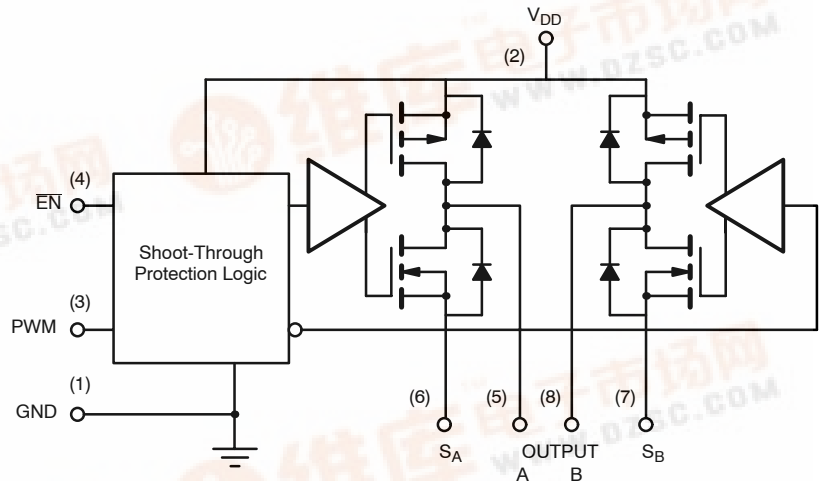

ORDERING INFORMATION

Part Number	Marking	Temperature Range	Package
Si9988DQ-T1	988	-40 to 85°C	Tape and Reel
Si9988DQ-T1—E3			





ABSOLUTE MAXIMUM RATINGS^a

V _{DD}	15 V
Voltage on any pin with respect to ground	-0.3 V to V _{DD} +0.3 V
Voltage on pins 5, 8 with respect to GND	-1 V to V _{DD} +1 V
Voltage on pins 6, 7	-0.3 V to GND +1 V
Peak Output Current	1 A
Storage Temperature	-65 to 150°C
Junction Temperature (T _J)	150°C

Continuous I _{out} current (T _J = 135°C, Y _{DD} = 5V)	
T _A = 25°C	0.67A
T _A = 85°C	0.47A
Power Dissipation ^b	0.83 W
θ _{JA}	120°C/W
Operating Temperature Range	-40 to 85°C

- Notes
- Device mounted with all leads soldered or welded to PC board.
 - Derate 8.3 mW/°C above 25°C.
 - T_J = T_A + (P_D)(θ_{JA}), P_D = Power Dissipation.

Stresses beyond those listed under "Absolute Maximum Ratings" may cause permanent damage to the device. These are stress ratings only, and functional operation of the device at these or any other conditions beyond those indicated in the operational sections of the specifications is not implied. Exposure to absolute maximum rating conditions for extended periods may affect device reliability.

RECOMMENDED OPERATING RANGE

V _{DD}	3.8 V to 13.2 V
Maximum Junction Temperature (T _J)	135°C

SPECIFICATIONS						
Parameter	Symbol	Test Conditions Unless Otherwise Specified V _{DD} = 3.8 to 13.2 V S _A @ GND, S _B @ GND	Limits D Suffix, -40 to 85°C			Unit
			Min ^a	Typ ^b	Max ^a	
Input (EN, PWM)						
Input Voltage High	V _{INH}		2			V
Input Voltage Low	V _{INL}				1	
Input Current with Input Voltage High	I _{INH}	V _{IN} = 13.2 V			1	μA
Input Current with Input Voltage Low	I _{INL}	V _{IN} = 0 V	-1			
Output						
Output Voltage High ^c	V _{OUTH}	I _{OUT} = -300 mA	V _{DD} = 10.8 V	10.55	10.70	V
			V _{DD} = 4.5 V	4.20	4.35	
			V _{DD} = 3.8 V	3.40	3.62	
Output Voltage Low ^c	V _{OUTL}	I _{OUT} = 300 mA	V _{DD} = 10.8 V		0.09	0.20
			V _{DD} = 4.5 V		0.12	0.25
			V _{DD} = 3.8 V		0.14	0.30
Output V Clamp High	V _{CLH}	EN = PWM ≥ 2 V	I _{OUT} = 100 mA		V _{DD} +0.7	V _{DD} +1.0
Output V Clamp Low	V _{CLL}		I _{OUT} = -100 mA	-1.0	-0.7	
Supply						
V _{DD} Supply Current	I _{DD}	EN = 0V, PWM = 100 kHz, V _{DD} = 5 V		1.0	1.5	mA
		EN = 4.5 V, PWM = 100 kHz, V _{DD} = 5.5 V		60	140	μA
		EN = PWM = 4.5 V, V _{DD} = 5.5 V		55	110	



SPECIFICATIONS						
Parameter	Symbol	Test Conditions Unless Otherwise Specified $V_{DD} = 3.8 \text{ to } 13.2 \text{ V}$ $S_A @ \text{GND}, S_B @ \text{GND}$	Limits D Suffix, $-40 \text{ to } 85^\circ\text{C}$			Unit
			Min ^a	Typ ^b	Max ^a	
Dynamic						
Propogation Delay – OUT_A^d	T_{PLH}	$V_{DD} = 5 \text{ V}, \overline{\text{EN}} = 0 \text{ V}$		300		nS
	T_{PHL}			115		
Propogation Delay – OUT_B^d	T_{PLH}			75		
	T_{PHL}			330		
Break-Before-Make ^d	BBM_{PLH}			225		
	BBM_{PHL}			215		

Notes

- a. The algebraic convention whereby the most negative value is a minimum and the most positive a maximum, is used in this data sheet.
- b. Typical values are for DESIGN AID ONLY, not guaranteed nor subject to production testing, measured $T_A = 25^\circ\text{C}$.
- c. Min and Max value mesaured at $T_J = 135^\circ\text{C}$.
- d. PLH = PWM low to high, PHL = PWM high to low.

TYPICAL CHARACTERISTICS (25°C UNLESS NOTED)

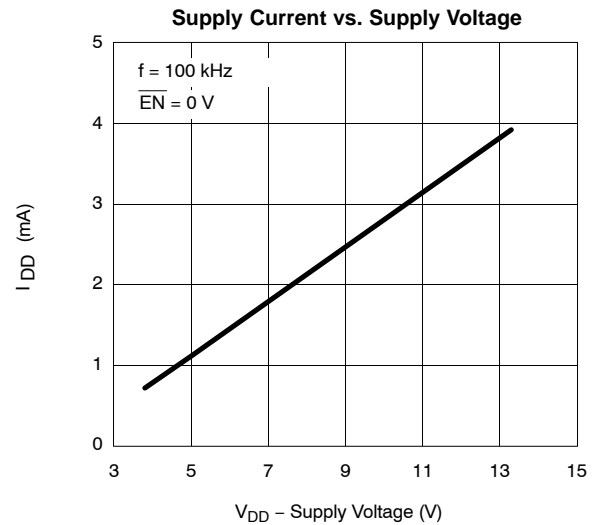
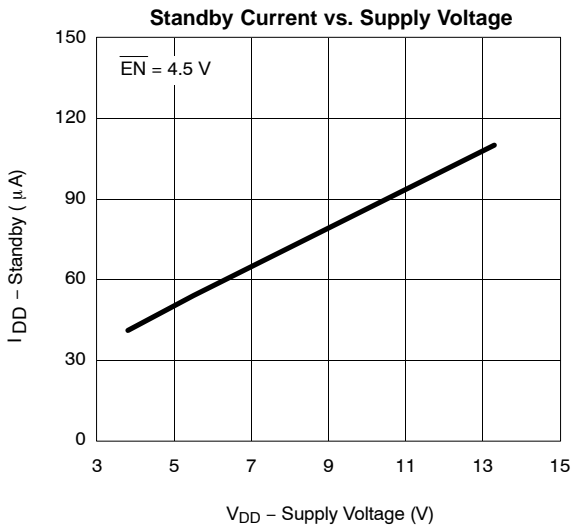
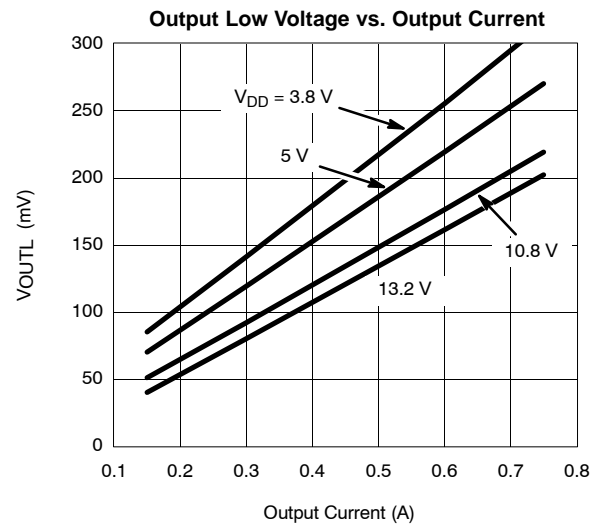
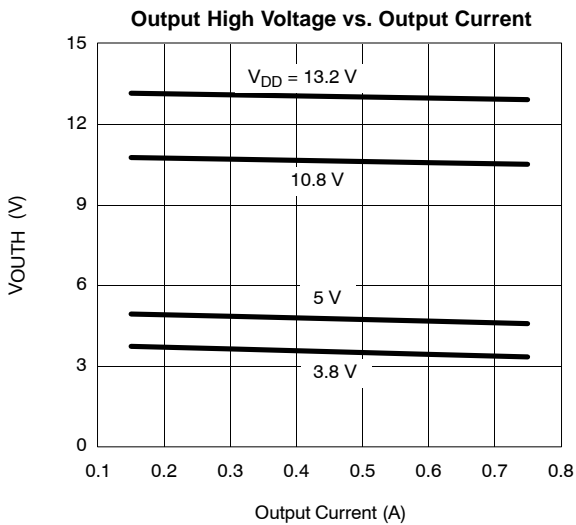

TYPICAL CHARACTERISTICS (25°C UNLESS NOTED)

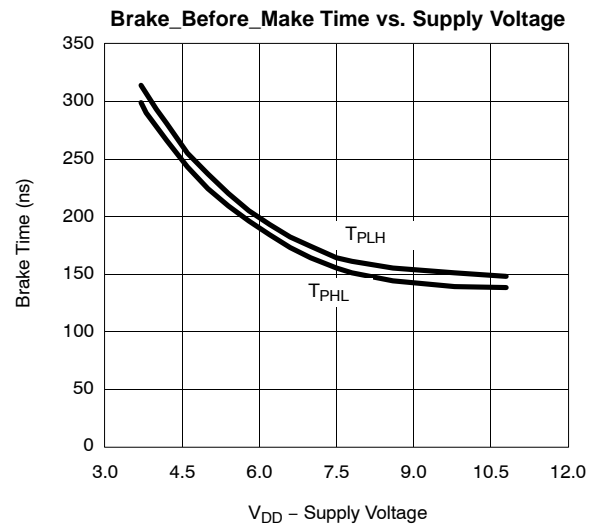
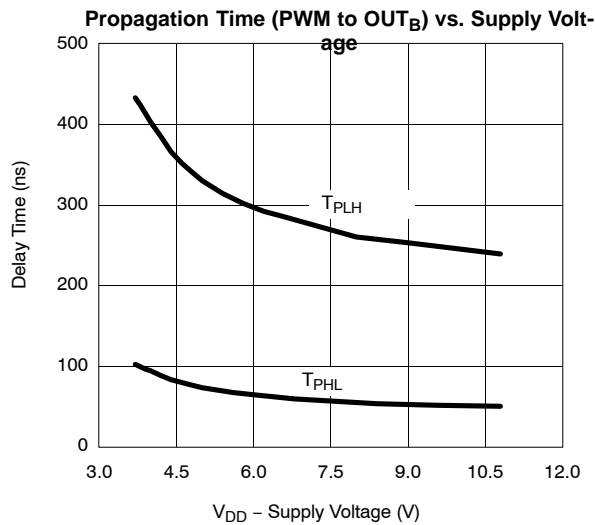
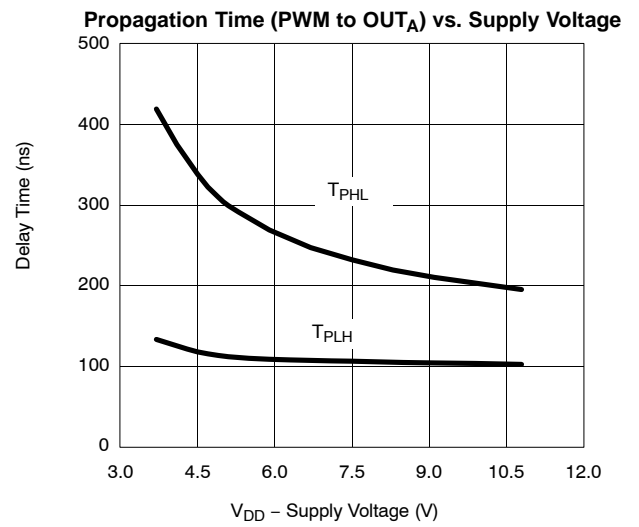
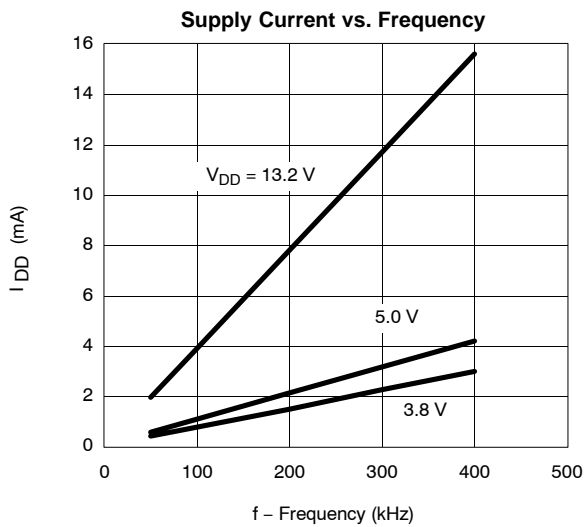
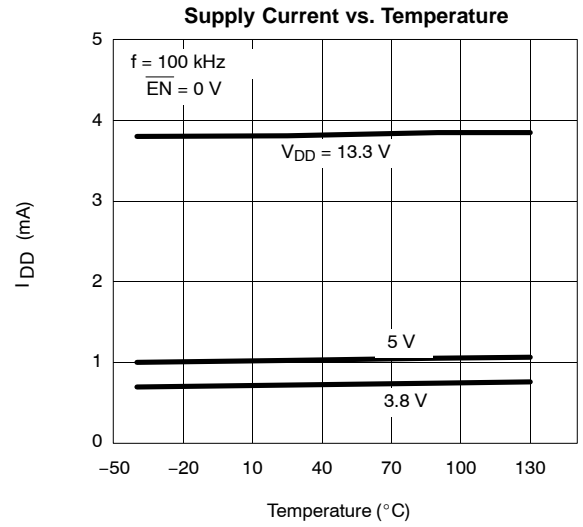
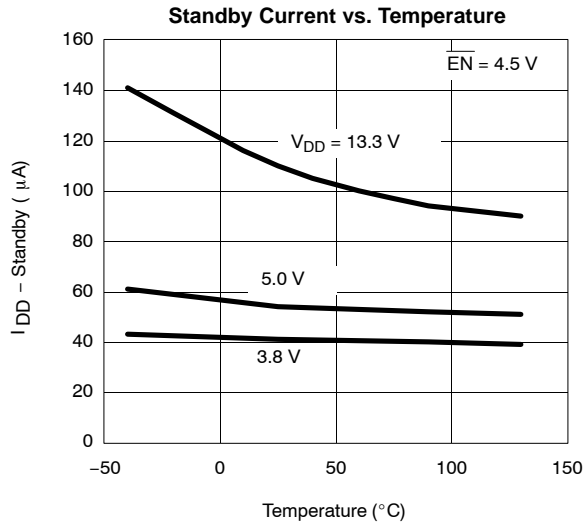

TIMING WAVEFORMS

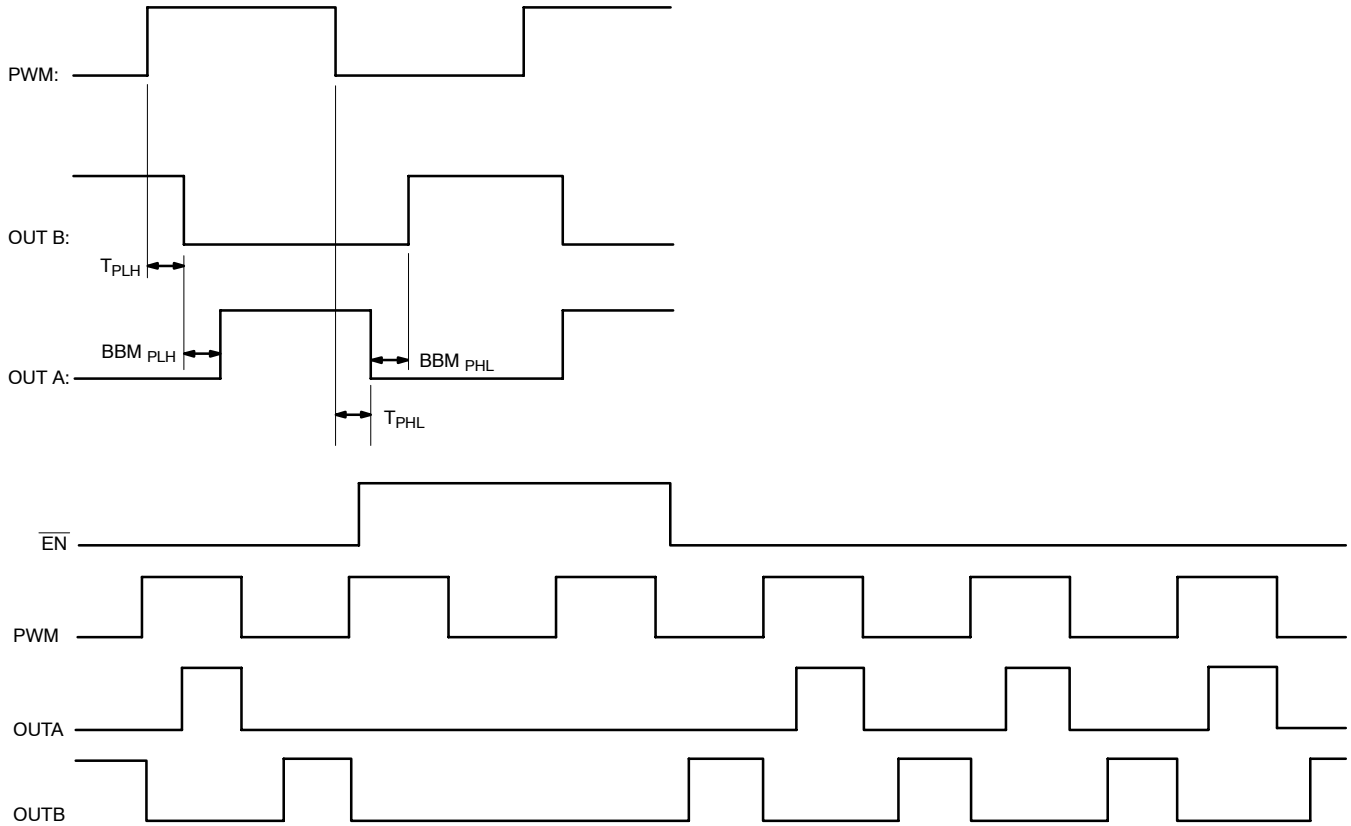

FIGURE 1.

Disclaimer

All product specifications and data are subject to change without notice.

Vishay Intertechnology, Inc., its affiliates, agents, and employees, and all persons acting on its or their behalf (collectively, "Vishay"), disclaim any and all liability for any errors, inaccuracies or incompleteness contained herein or in any other disclosure relating to any product.

Vishay disclaims any and all liability arising out of the use or application of any product described herein or of any information provided herein to the maximum extent permitted by law. The product specifications do not expand or otherwise modify Vishay's terms and conditions of purchase, including but not limited to the warranty expressed therein, which apply to these products.

No license, express or implied, by estoppel or otherwise, to any intellectual property rights is granted by this document or by any conduct of Vishay.

The products shown herein are not designed for use in medical, life-saving, or life-sustaining applications unless otherwise expressly indicated. Customers using or selling Vishay products not expressly indicated for use in such applications do so entirely at their own risk and agree to fully indemnify Vishay for any damages arising or resulting from such use or sale. Please contact authorized Vishay personnel to obtain written terms and conditions regarding products designed for such applications.

Product names and markings noted herein may be trademarks of their respective owners.