

Distinctive Characteristics

Subminiature size saves space on PC boards.

Specifically developed for logic-level applications.

Antistatic superstructure, consisting of the carbon impregnated bushing and the support bracket, prevents static discharge to the contacts. Static electricity from an operator's touch travels from actuator through the bushing and bracket to the PC board.

Locking lever mechanism offered as a toggle option.

Optional threaded, 6mm diameter bushing for panel seal mounting meets IP65 of IEC60529 specifications (similar to NEMA 4 and 13).

Totally sealed body construction prevents contact contamination and allows time- and money-saving soldering and cleaning. Epoxy sealed terminals lock out flux and other contaminants.

Award-winning STC contact mechanism with benefits unavailable in conventional mechanisms: smoother, positive detent actuation, increased contact stability and unparalleled logic-level reliability. (Additional STC details in Terms & Acronyms; see Supplement section.)

.100" x .100" (2.54mm x 2.54mm) terminal spacing conforms to standard PC board grid spacing.

Illuminated toggles available and shown in the Illuminated Other section.

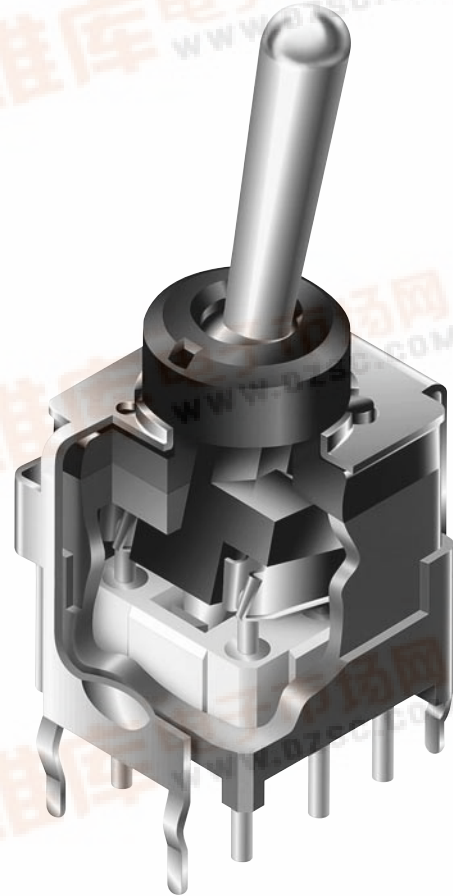

Actual Size

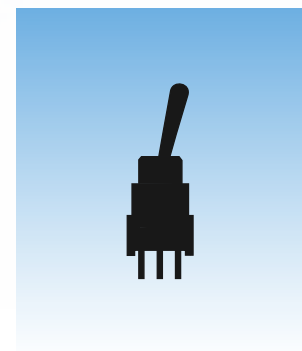

General Specifications

Electrical Capacity (Resistive Load)

Logic Level: 0.4VA maximum @ 28V AC/DC maximum
 (Applicable Range 0.1mA ~ 0.1A @ 20mV ~ 28V)
 Note: Find additional explanation of operating range in Supplement section.

Other Ratings

Contact Resistance: 50 milliohms maximum
Insulation Resistance: 500 megohms minimum @ 500V DC
Dielectric Strength: 500V AC minimum for 1 minute minimum
Mechanical Life: 100,000 operations minimum for On-None-On & On-Off-On
 50,000 operations minimum for other circuits
 50,000 operations minimum for locking lever models
Electrical Life: 50,000 operations minimum
Nominal Operating Force: Toggles A, A1, E & K with Long Paddle: 1.47N (momentary); 1.18N (maintained)
 Toggles J & H & K with Short Paddle: 2.72N (momentary); 1.84N (maintained)
 Toggle L: 0.59N
Contact Timing: Nonshorting (break-before-make)
Angle of Throw: 26°

Materials & Finishes

Toggle: Nickel plated brass
Bushing: Carbon blended polyamide; nickel plated zinc alloy for locking levers & threaded bushing
Gasket: Nitrile butadiene rubber
Case Housing: Glass fiber reinforced polyamide
Support Bracket: Tin plated phosphor bronze
Movable Contact: Phosphor bronze with gold plating
Stationary Contacts: Copper alloy with gold plating
Terminals: Copper alloy with gold plating

Environmental Data

Operating Temperature Range: -30°C through +85°C (-22°F through +185°F)
Humidity: 90 ~ 95% humidity for 96 hours @ 40°C (104°F)
Vibration: 10 ~ 55Hz with peak-to-peak amplitude of 1.5mm traversing the frequency range & returning in 1 minute; 3 right angled directions for 2 hours
Shock: 50G (490m/s²) acceleration (tested in 6 right angled directions, with 5 shocks in each direction)

Installation

Mounting Torque: .30 ~ .45Nm (2.65 ~ 3.98 lb•in) for A1 actuator with threaded bushing only

PCB Processing

Soldering: Wave Soldering Recommended: See Profile A in Supplement section.
 Manual Soldering: See Profile A in Supplement section.
Cleaning: Automated cleaning. See Cleaning specifications in Supplement section.

Standards & Certifications

Flammability Standards: UL94V-0 available
UL Recognition or CSA Certification: The B Series toggles have not been tested for UL recognition or CSA certification. These switches are designed for use in a low-voltage, low-current, logic-level circuit. When used as intended in a logic-level circuit, the results do not produce hazardous energy.

TYPICAL SWITCH ORDERING EXAMPLE

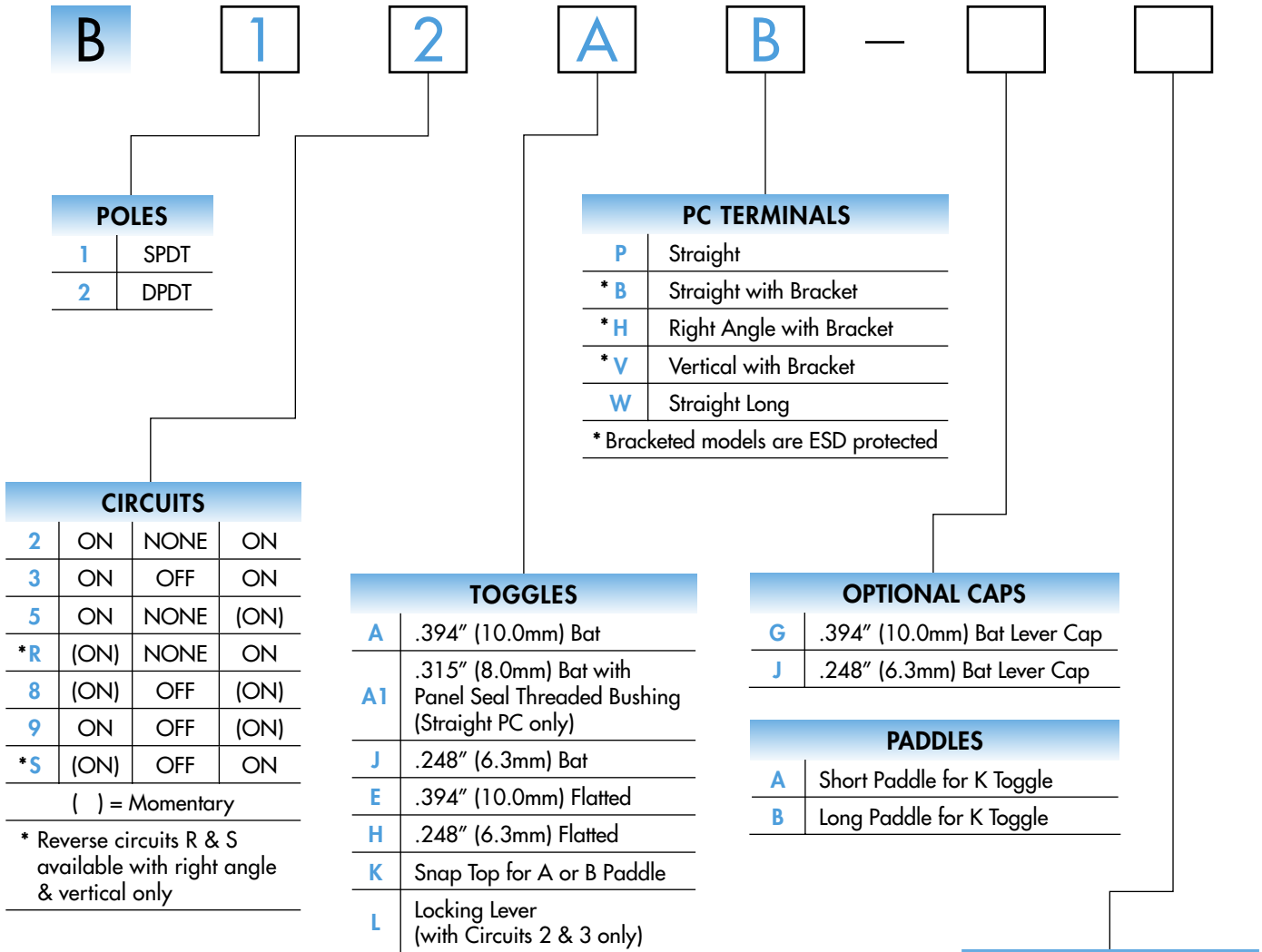

POLES	
1	SPDT
2	DPDT

PC TERMINALS	
P	Straight
*B	Straight with Bracket
*H	Right Angle with Bracket
*V	Vertical with Bracket
W	Straight Long

* Bracketed models are ESD protected

CIRCUITS			
2	ON	NONE	ON
3	ON	OFF	ON
5	ON	NONE	(ON)
*R	(ON)	NONE	ON
8	(ON)	OFF	(ON)
9	ON	OFF	(ON)
*S	(ON)	OFF	ON

TOGGLES	
A	.394" (10.0mm) Bat
A1	.315" (8.0mm) Bat with Panel Seal Threaded Bushing (Straight PC only)
J	.248" (6.3mm) Bat
E	.394" (10.0mm) Flatted
H	.248" (6.3mm) Flatted
K	Snap Top for A or B Paddle
L	Locking Lever (with Circuits 2 & 3 only)

OPTIONAL CAPS	
G	.394" (10.0mm) Bat Lever Cap
J	.248" (6.3mm) Bat Lever Cap

PADDLES	
A	Short Paddle for K Toggle
B	Long Paddle for K Toggle

() = Momentary
 * Reverse circuits R & S available with right angle & vertical only





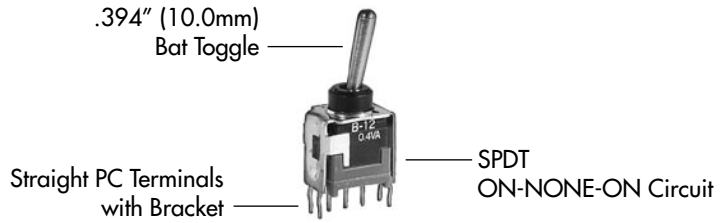

CAP COLORS		PADDLE COLORS	
A	Black	A	
B	White	B	
C	Red	C	
---	Yellow	E	
---	Green	F	
---	Blue	G	
---	Gray	H	

DESCRIPTION FOR TYPICAL ORDERING EXAMPLE

B12AB

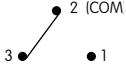
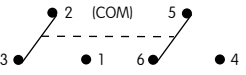

POLES & CIRCUITS

Pole	Model	Toggle Position () = Momentary			Connected Terminals			Throw & Schematics
		Up 	Center 	Down 	Up 	Center 	Down 	
SP	B12	ON	NONE	ON	2-3	OPEN	2-1	Note: Terminal numbers are not actually on the switch. 
	B13	ON	OFF	ON				
	B15	ON	NONE	(ON)				
	B1R	(ON)	NONE	ON				
	B18	(ON)	OFF	(ON)				
	B19	ON	OFF	(ON)				
	B1S	(ON)	OFF	ON				
DP	B22	ON	NONE	ON	2-3 5-6	OPEN	2-1 5-4	
	B23	ON	OFF	ON				
	B25	ON	NONE	(ON)				
	B2R	(ON)	NONE	ON				
	B28	(ON)	OFF	(ON)				
	B29	ON	OFF	(ON)				
	B2S	(ON)	OFF	ON				

TOGGLES

Standard Material & Finish: Brass with Bright Nickel

A .394" (10.0mm) Bat

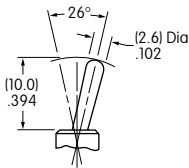

A1 .315" (8.0mm) Bat with Panel Seal Threaded Bushing

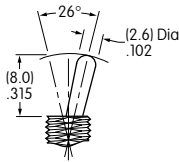

J .248" (6.3mm) Bat

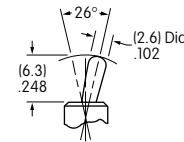

E .394" (10.0mm) Flatted

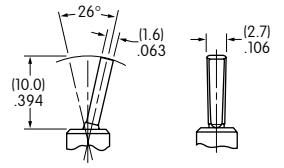

H .248" (6.3mm) Flatted

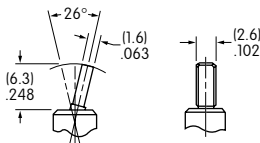

K Snap Top for Paddles

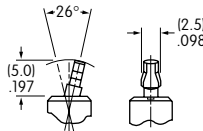

L Locking Lever

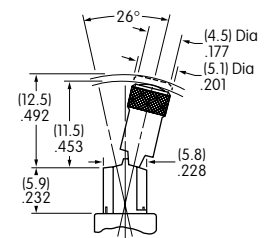

PC TERMINALS

Use of a support bracket is recommended to increase PCB mounting strength and stability.

P

Straight

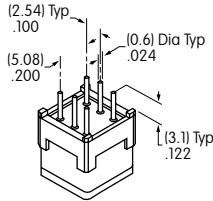

B

Straight with Bracket

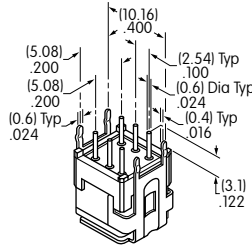

H

Right Angle with Bracket

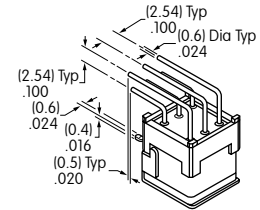

V

Vertical with Bracket

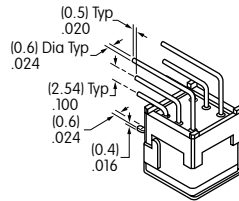

W

Straight Long

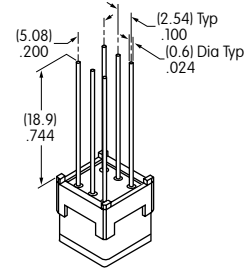

OPTIONAL CAPS

G

AT4003
.394" (10.0mm) Bat Lever Cap

Material: PVC
Colors Available:
A, B, C

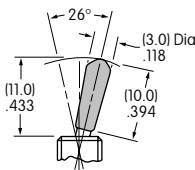

J

AT4064
.248" (6.3mm) Bat Lever Cap

Material: PVC
Colors Available:
A, B, C

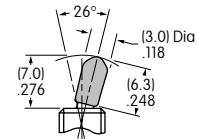

PADDLES

A

AT467
Short Paddle for K Toggle

Material: Polyamide
Colors Available:
A, B, C, E, F, G, H

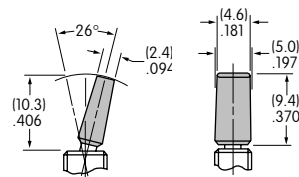

B

AT468
Long Paddle for K Toggle

Material: Polyamide
Colors Available:
A, B, C, E, F, G, H

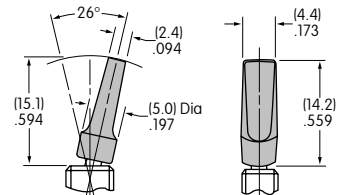

Color Codes:

A

Black

B

White

C

Red

E

Yellow

F

Green

G

Blue

H

Gray

TYPICAL SWITCH DIMENSIONS

Straight PC



B12AP

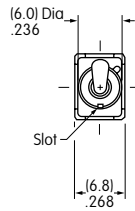

Single Pole

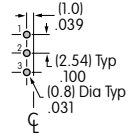
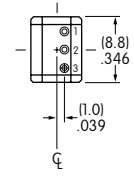
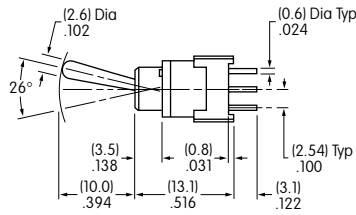

Straight PC



B22AP

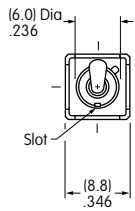

Double Pole

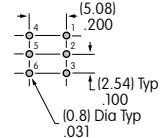
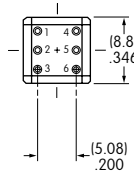
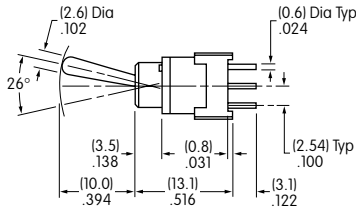

Straight PC • Bracket



B12AB

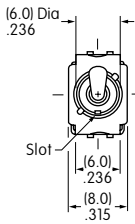

Single Pole

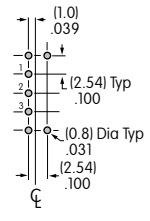
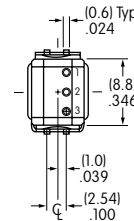
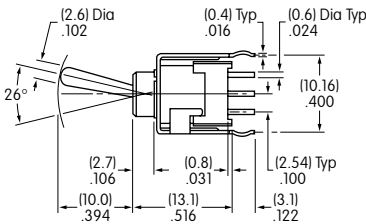

Straight PC • Bracket



B22AB

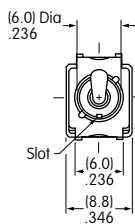

Double Pole

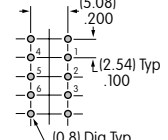
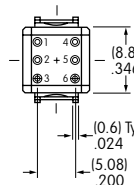
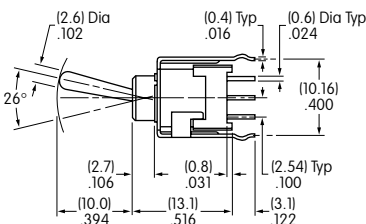

Right Angle PC



B12AH

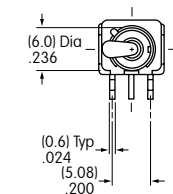

Single Pole

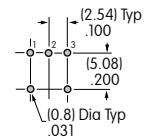
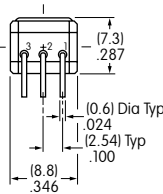
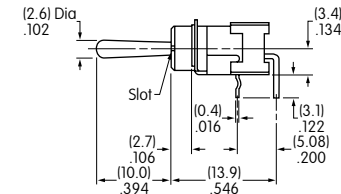

TYPICAL SWITCH DIMENSIONS

Right Angle PC



B22AH

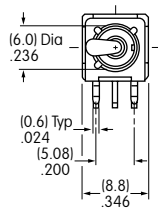

Double Pole

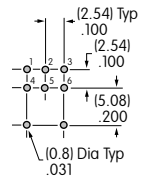
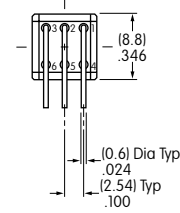
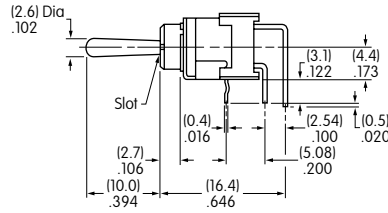

Vertical PC



B12AV

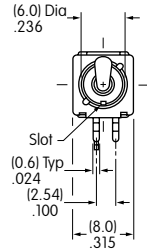

Single Pole

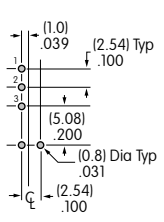
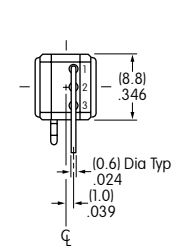
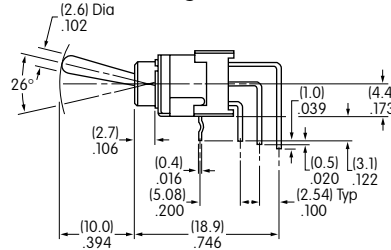

Vertical PC



B22AV

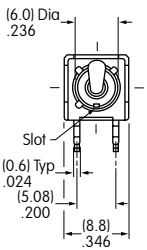

Double Pole

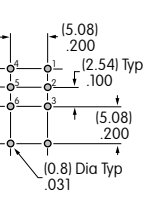
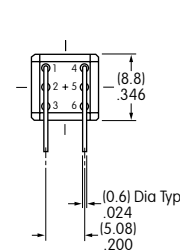
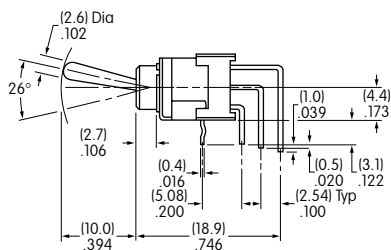

Locking Lever • Straight PC • Bracket



B12LB

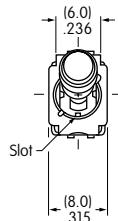

Single Pole

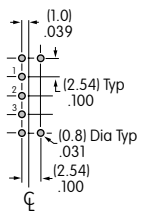
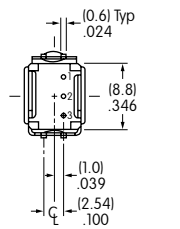
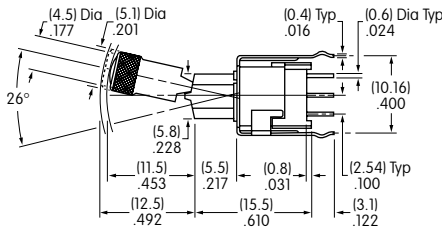

Locking Lever • Straight PC • Bracket



B22LB

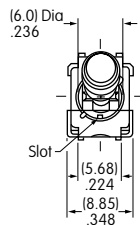

Double Pole

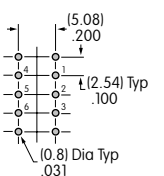
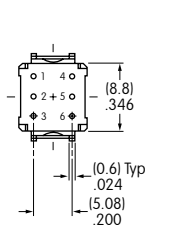
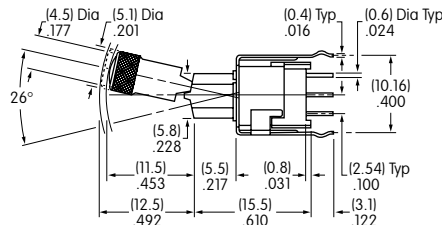

TYPICAL SWITCH DIMENSIONS

Threaded Bushing • Straight PC

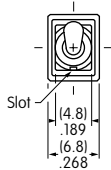

Panel Seal • Single Pole

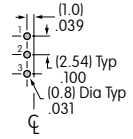
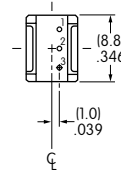
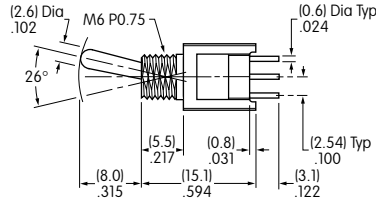

B12A1P

Threaded Bushing • Straight PC

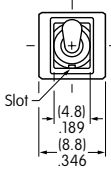

Panel Seal • Double Pole

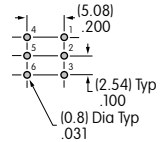
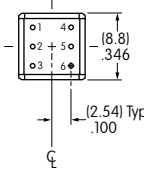
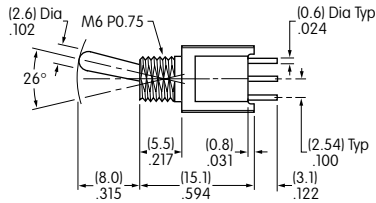

B22A1P

STANDARD HARDWARE & PANEL CUTOUT

AT513M Metric Hex Nut

Material:
Brass,
Nickel plated

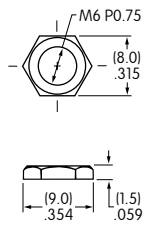

AT063 Gasket

Material:
Nitrile butadiene
rubber

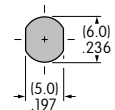
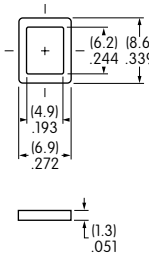

Maximum Panel Thickness
with Standard Hardware:
.087" (2.2mm)