

Self-Protected FET with Temperature and Current Limit

40 V, 6.5 A, Single N-Channel, DPAK

Self-protected FETs are a series of power MOSFETs which utilize ON Semiconductor HDPlus™ technology. The self-protected MOSFET incorporates protection features such as integrated thermal and current limits. The self-protected MOSFETs include an integrated Drain-to-Gate Clamp that provides overvoltage protection from transients and avalanche. The device is protected from Electrostatic Discharge (ESD) by utilizing an integrated Gate-to-Source Clamp.

Features

- Short Circuit Protection
- In Rush Current Limit
- Thermal Shutdown with Automatic Restart
- Avalanche Rated
- Overvoltage Protection
- ESD Protection (4 kV HBM)
- Controlled Slew Rate for Low Noise Switching
- AEC Q101 Qualified
- This is a Pb-Free Device

Applications

- Solenoid Driver
- Relay Driver
- Small Motors
- Lighting
- Relay Replacement
- Load Switching



ON Semiconductor®

<http://onsemi.com>

V _{DSS} (Clamped)	R _{DS(on)} Typ	I _D Typ (Limited)
40 V	110 mΩ @ 10 V	6.5 A

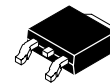
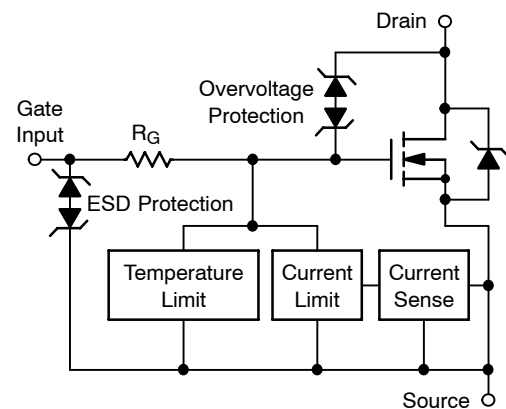

**DPAK
CASE 369C
STYLE 2**

MARKING DIAGRAM

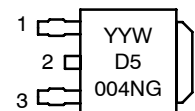

D5004N = Device Code
 Y = Year
 WW = Work Week
 G = Pb-Free Device

1 = Gate
 2 = Drain
 3 = Source

ORDERING INFORMATION

Device	Package	Shipping†
NID5004NT4G	DPAK (Pb-Free)	2500/Tape & Reel

†For information on tape and reel specifications, including part orientation and tape sizes, please refer to our Tape and Reel Packaging Specification Brochure, BRD8011/D.

NID5004N

MOSFET MAXIMUM RATINGS (T_A = 25°C unless otherwise noted)

Rating	Symbol	Value	Unit
Drain-to-Source Voltage Internally Clamped	V _{DSS}	44	Vdc
Gate-to-Source Voltage	V _{GS}	± 14	Vdc
Drain Current Continuous	I _D	Internally Limited	
Total Power Dissipation @ T _A = 25°C (Note 1) @ T _A = 25°C (Note 2)	P _D	1.3 2.5	W
Thermal Resistance Junction-to-Case Junction-to-Ambient (Note 1) Junction-to-Ambient (Note 2)	R _{θJC} R _{θJA} R _{θJA}	3.0 95 50	°C/W
Single Pulse Drain-to-Source Avalanche Energy (V _{DD} = 30 Vdc, V _{GS} = 5.0 Vdc, I _L = 1.8 Apk, L = 160 mH, R _G = 25 Ω) (Note 3)	E _{AS}	273	mJ
Operating and Storage Temperature Range (Note 4)	T _J , T _{stg}	-55 to 150	°C

Stresses exceeding Maximum Ratings may damage the device. Maximum Ratings are stress ratings only. Functional operation above the Recommended Operating Conditions is not implied. Extended exposure to stresses above the Recommended Operating Conditions may affect device reliability.

1. Surface mounted onto minimum pad size (100 sq/mm) FR4 PCB, 1 oz cu.
2. Mounted onto 1" square pad size (700 sq/mm) FR4 PCB, 1 oz cu.
3. Not subject to Production Test
4. Normal pre-fault operating range. See thermal limit range conditions.

NID5004N

MOSFET ELECTRICAL CHARACTERISTICS (T_J = 25°C unless otherwise noted)

Characteristic	Symbol	Min	Typ	Max	Unit
----------------	--------	-----	-----	-----	------

OFF CHARACTERISTICS

Drain-to-Source Clamped Breakdown Voltage (V _{GS} = 0 V, I _D = 2 mA)	V _{(BR)DSS}	36	40	44	V
Zero Gate Voltage Drain Current (V _{DS} = 32 V, V _{GS} = 0 V)	I _{DSS}	-	27	100	μA
Gate Input Current (V _{GS} = 5.0 V, V _{DS} = 0 V)	I _{GSS}	-	45	200	μA

ON CHARACTERISTICS

Gate Threshold Voltage (V _{DS} = V _{GS} , I _D = 150 μA) Threshold Temperature Coefficient	V _{GS(th)}	1.0 -	1.85 5.0	2.2 -	V -mV/°C
Static Drain-to-Source On-Resistance (Note 5) (V _{GS} = 10 V, I _D = 2.0 A, T _J @ 25°C)	R _{DS(on)}	-	110	130	mΩ
Static Drain-to-Source On-Resistance (Note 5) (V _{GS} = 5.0 V, I _D = 2.0 A, T _J @ 25°C) (V _{GS} = 5.0 V, I _D = 2.0 A, T _J @ 150°C)	R _{DS(on)}	- -	130 240	150 270	mΩ
Source-Drain Forward On Voltage (I _S = 7.0 A, V _{GS} = 0 V)	V _{SD}	-	0.9	1.1	V

SWITCHING CHARACTERISTICS (Note 6)

Turn-on Delay Time	R _L = 6.6 Ω, V _{in} = 0 to 10 V, V _{DD} = 13.8 V, I _D = 2.0 A, 10% V _{in} to 10% I _D	td(on)	-	97	115	ns
Turn-on Rise Time	R _L = 6.6 Ω, V _{in} = 0 to 10 V, V _{DD} = 13.8 V, I _D = 2.0 A, 10% I _D to 90% I _D	t _{rise}	-	282	300	ns
Turn-off Delay Time	R _L = 6.6 Ω, V _{in} = 0 to 10 V, V _{DD} = 13.8 V, I _D = 2.0 A, 90% V _{in} to 90% I _D	td(off)	-	930	1020	ns
Turn-off Fall Time	R _L = 6.6 Ω, V _{in} = 0 to 10 V, V _{DD} = 13.8 V, I _D = 2.0 A, 90% I _D to 10% I _D	t _{fall}	-	690	750	ns
Slew Rate ON	R _L = 6.6 Ω, V _{in} = 0 to 10 V, V _{DD} = 13.8 V, I _D = 2.0 A, 70% to 50% V _{DD}	dV _{DS} /dT _{on}	-	64	-	V/μs
Slew Rate OFF	R _L = 6.6 Ω, V _{in} = 0 to 10 V, V _{DD} = 13.8 V, I _D = 2.0 A, 50% to 70% V _{DD}	dV _{DS} /dT _{off}	-	28	-	V/μs

SELF PROTECTION CHARACTERISTICS (T_J = 25°C unless otherwise noted) (Note 7)

Current Limit	V _{DS} = 10 V, V _{GS} = 5.0 V, T _J = 25°C (Note 8) V _{DS} = 10 V, V _{GS} = 5.0 V, T _J = 100°C (Note 6, 8) V _{DS} = 10 V, V _{GS} = 10 V, T _J = 25°C (Note 6, 8)	I _{LIM}	4.0 4.0 -	6.5 5.5 7.9	11 11 -	A
Temperature Limit (Turn-off)	V _{GS} = 5.0 V (Note 6)	T _{LIM(off)}	150	180	200	°C
Thermal Hysteresis	V _{GS} = 5.0 V	ΔT _{LIM(on)}	-	10	-	°C
Temperature Limit (Turn-off)	V _{GS} = 10 V (Note 6)	T _{LIM(off)}	150	180	200	°C
Thermal Hysteresis	V _{GS} = 10 V	ΔT _{LIM(on)}	-	20	-	°C
Input Current during Thermal Fault	V _{DS} = 0 V, V _{GS} = 5.0 V, T _J = T _J > T _(fault) (Note 6) V _{DS} = 0 V, V _{GS} = 10 V, T _J = T _J > T _(fault) (Note 6)	I _{g(fault)}	5.5 12	5.2 11	-	mA

ESD ELECTRICAL CHARACTERISTICS (T_J = 25°C unless otherwise noted)

Electrostatic Discharge Capability Human Body Model (HBM) Machine Model (MM) (Note 6)	ESD	4000 400	- -	- -	V
---------------------------------------------------------------------------------------------	-----	-------------	--------	--------	---

- Pulse Test: Pulse Width ≤ 300 μs, Duty Cycle ≤ 2%.
- Not subject to Production Test
- Fault conditions are viewed as beyond the normal operating range of the part.
- Current limit measured at 380 μs after gate pulse.

TYPICAL PERFORMANCE CURVES

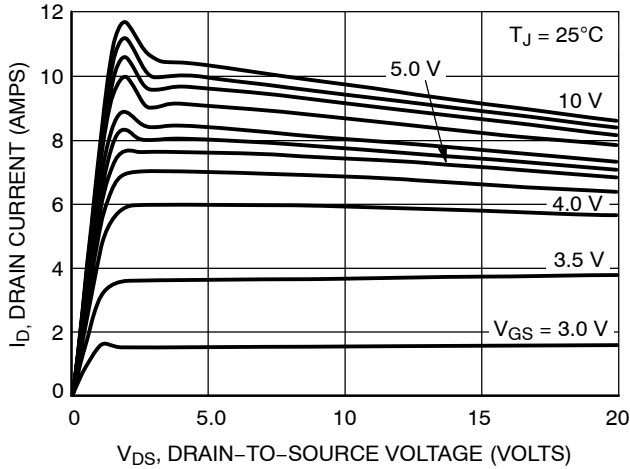

Figure 1. On-Region Characteristics

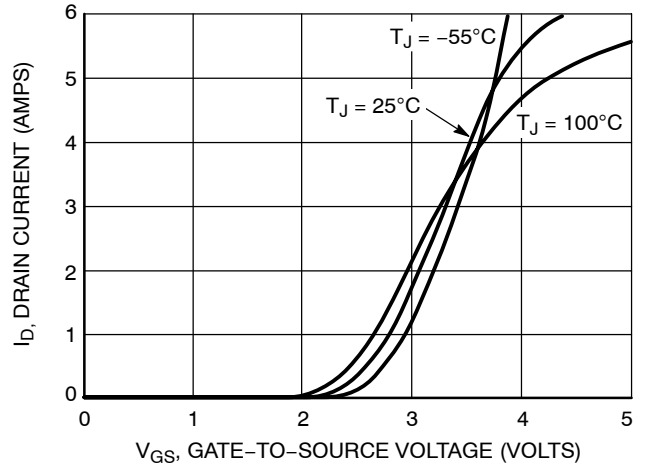

Figure 2. Transfer Characteristics

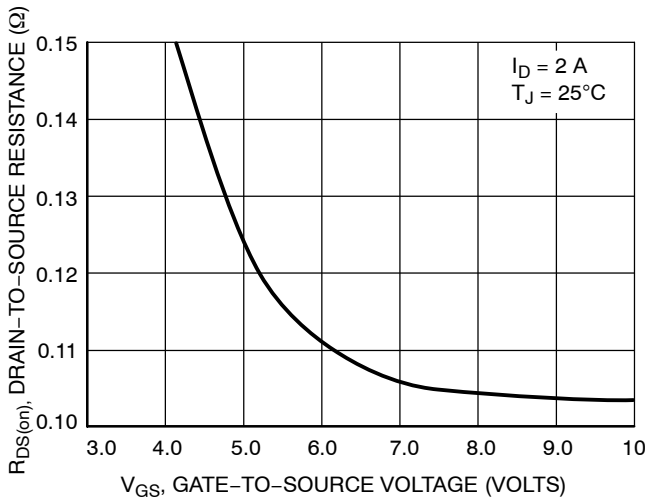

Figure 3. On-Resistance vs. Gate-to-Source Voltage

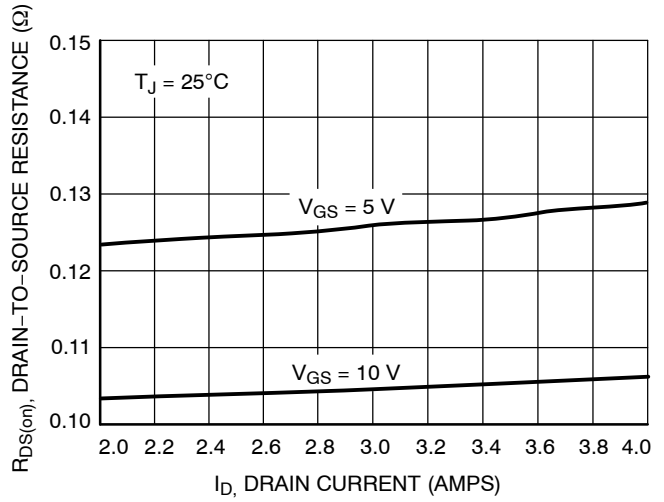

Figure 4. On-Resistance vs. Drain Current

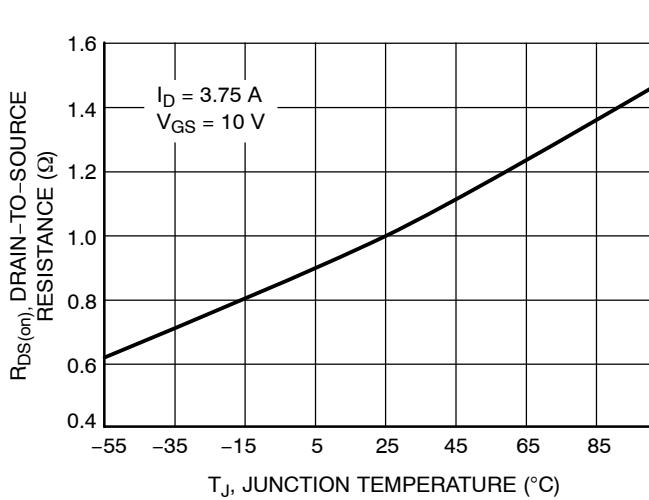

Figure 5. On-Resistance Variation with Temperature

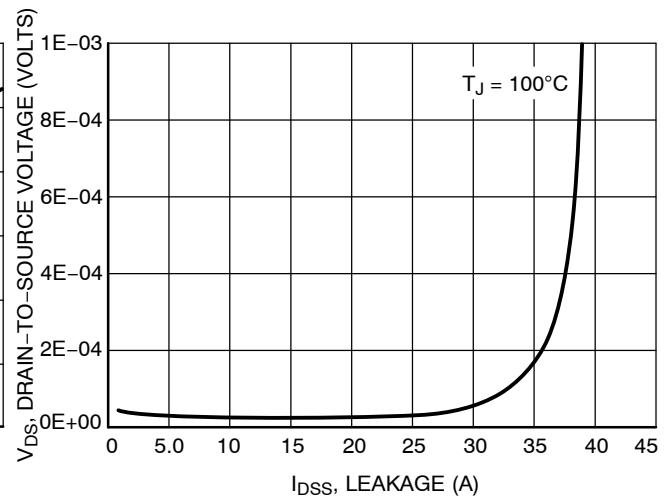

Figure 6. Drain-to-Source Leakage Current vs. Voltage

[查询"NID5004NT4G"供应商](#)

z TYPICAL PERFORMANCE CURVES

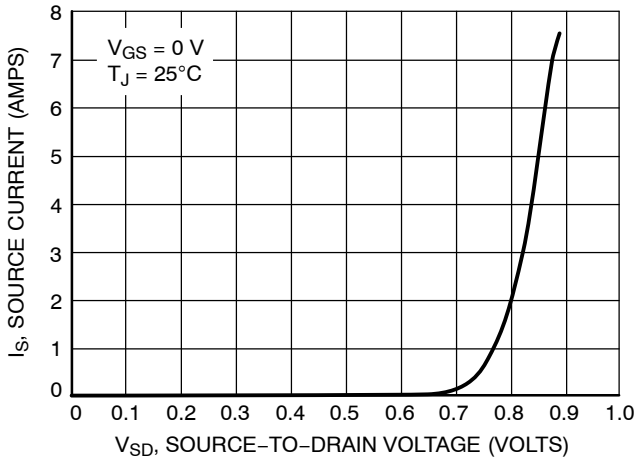

Figure 7. Diode Forward Voltage vs. Current

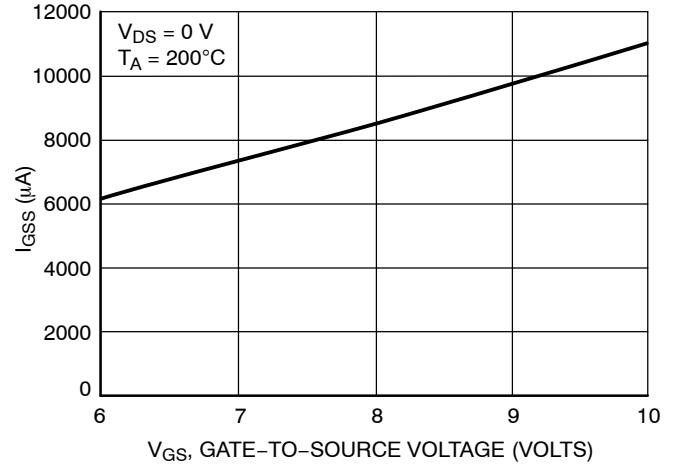

Figure 8. Input Current vs. Gate Voltage

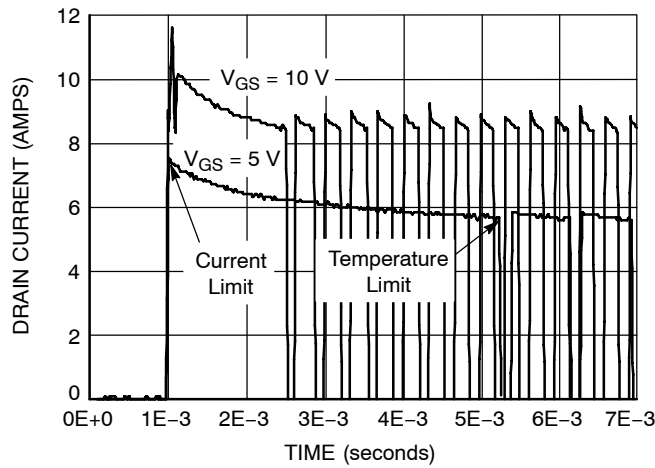

Figure 9. Short Circuit Response*

*(Actual thermal cycling response in short circuit dependent on device power level, thermal mounting, and ambient temperature conditions)

NID5004N

查询"NID5004NT4G"供应商

PACKAGE DIMENSIONS

DPAK
CASE 369C-01
ISSUE O

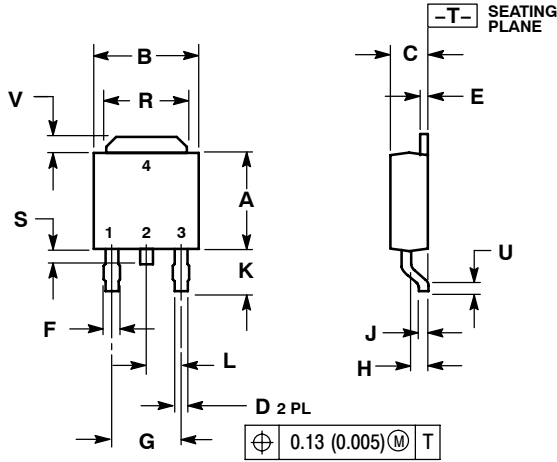

DIM	INCHES		MILLIMETERS	
	MIN	MAX	MIN	MAX
A	0.235	0.245	5.97	6.22
B	0.250	0.265	6.35	6.73
C	0.086	0.094	2.19	2.38
D	0.027	0.035	0.69	0.88
E	0.018	0.023	0.46	0.58
F	0.037	0.045	0.94	1.14
G	0.180 BSC		4.58 BSC	
H	0.034	0.040	0.87	1.01
J	0.018	0.023	0.46	0.58
K	0.102	0.114	2.60	2.89
L	0.090 BSC		2.29 BSC	
R	0.180	0.215	4.57	5.45
S	0.025	0.040	0.63	1.01
U	0.020	---	0.51	---
V	0.035	0.050	0.89	1.27
Z	0.155	---	3.93	---

STYLE 2:
PIN 1. GATE
2. DRAIN
3. SOURCE
4. DRAIN

SOLDERING FOOTPRINT*

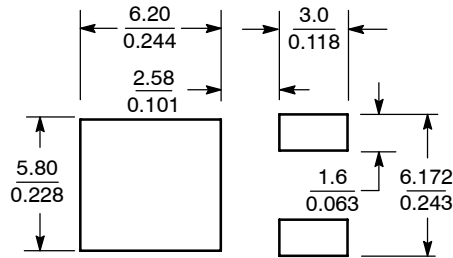

SCALE 3:1 $\left(\frac{\text{mm}}{\text{inches}}\right)$

*For additional information on our Pb-Free strategy and soldering details, please download the ON Semiconductor Soldering and Mounting Techniques Reference Manual, SOLDERRM/D.

HDPlus is a trademark of Semiconductor Components Industries, LLC (SCILLC)

ON Semiconductor and are registered trademarks of Semiconductor Components Industries, LLC (SCILLC). SCILLC reserves the right to make changes without further notice to any products herein. SCILLC makes no warranty, representation or guarantee regarding the suitability of its products for any particular purpose, nor does SCILLC assume any liability arising out of the application or use of any product or circuit, and specifically disclaims any and all liability, including without limitation special, consequential or incidental damages. "Typical" parameters which may be provided in SCILLC data sheets and/or specifications can and do vary in different applications and actual performance may vary over time. All operating parameters, including "Typicals" must be validated for each customer application by customer's technical experts. SCILLC does not convey any license under its patent rights nor the rights of others. SCILLC products are not designed, intended, or authorized for use as components in systems intended for surgical implant into the body, or other applications intended to support or sustain life, or for any other application in which the failure of the SCILLC product could create a situation where personal injury or death may occur. Should Buyer purchase or use SCILLC products for any such unintended or unauthorized application, Buyer shall indemnify and hold SCILLC and its officers, employees, subsidiaries, affiliates, and distributors harmless against all claims, costs, damages, and expenses, and reasonable attorney fees arising out of, directly or indirectly, any claim of personal injury or death associated with such unintended or unauthorized use, even if such claim alleges that SCILLC was negligent regarding the design or manufacture of the part. SCILLC is an Equal Opportunity/Affirmative Action Employer. This literature is subject to all applicable copyright laws and is not for resale in any manner.

PUBLICATION ORDERING INFORMATION

LITERATURE FULFILLMENT:
Literature Distribution Center for ON Semiconductor
P.O. Box 61312, Phoenix, Arizona 85082-1312 USA
Phone: 480-829-7710 or 800-344-3860 Toll Free USA/Canada
Fax: 480-829-7709 or 800-344-3867 Toll Free USA/Canada
Email: orderlit@onsemi.com

N. American Technical Support: 800-282-9855 Toll Free
USA/Canada

Japan: ON Semiconductor, Japan Customer Focus Center
2-9-1 Kamimeguro, Meguro-ku, Tokyo, Japan 153-0051
Phone: 81-3-5773-3850

ON Semiconductor Website: <http://onsemi.com>

Order Literature: <http://www.onsemi.com/litorder>

For additional information, please contact your local Sales Representative.

NID5004N/D