

### General Description

The MIC94070-73 are high-side load switches designed for operation between 1.7V to 5.5V. The devices contain a low on-resistance P-channel MOSFET that supports 1.2A of continuous current. The MIC94071 and MIC94073 feature an active load discharge circuit which insures capacitive loads retain no charge when the main switch is in an OFF state.

MIC94070-71 feature rapid turn on while MIC94072-73 provide a slew rate controlled Soft-Start turn-on of 800 $\mu$ s (typical) to prevent in-rush current from glitching supply rails.

An active pull-down on the enable input keeps MIC94070-73 in a default OFF state until the EN pin is pulled to a high level. Built-in level shift circuitry allows low voltage logic signals to switch higher supply voltages, or vice versa; high level logic signals can control low level voltages.

MIC94070-73's operating voltage range makes them suitable for 1-cell Lithium ion and 2- to 3-cell NiMH/NiCad/Alkaline powered systems, as well as all 5V applications. Their low operating current of 2 $\mu$ A and low shutdown current of <1 $\mu$ A maximize battery life.

Data sheets and support documentation can be found on Micrel's web site at: [www.micrel.com](http://www.micrel.com).

### Features

- 1.7V to 5.5V input voltage range
- 1.2A continuous operating current
- 3A pulse current
- 120m $\Omega$  R<sub>DS(on)</sub> (typical)
- Built-in level shift for control logic; can be operated by 1.5V logic.
- Low 2 $\mu$ A quiescent current
- Soft-Start: MIC94072/73
- Micro-power shutdown <1 $\mu$ A
- Load discharge circuit: MIC94071, MIC94073
- Space saving 1.2mm x 1.6mm Thin MLF<sup>®</sup> package

### Applications

- Load switch in portable applications:
  - Cellular phones
  - PDAs
  - MP3 players
  - Digital Cameras
  - Portable instrumentation
- Battery switch-over circuits
- Level translator

### Typical Application

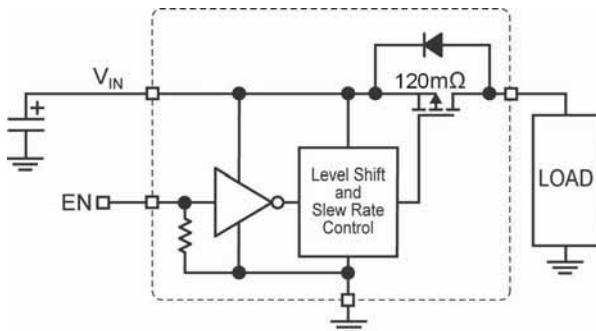

**MIC94070, 72**  
Load Switch Application

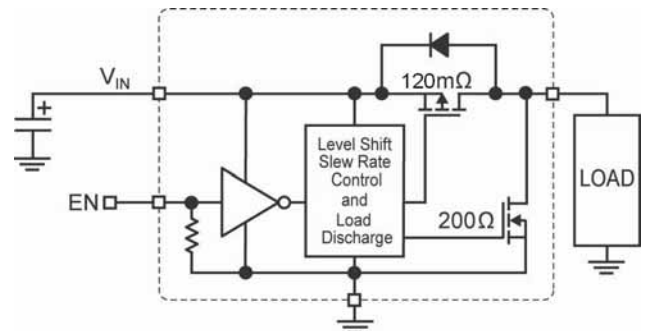

**MIC94071, 73**  
Load Switch with Capacitive Load Discharge

[查询"MIC94070"供应商](#)

## Ordering Information

Part Number		Part Marking <sup>(1)</sup>		Fast Turn On	Soft-Start	Load Discharge	Package
Standard	Pb-Free	Standard	Pb-Free				
—	MIC94070YC6	—	70P	•			SC-70-6
—	MIC94071YC6	—	71P	•		•	SC-70-6
—	MIC94072YC6	—	72P		•		SC-70-6
—	MIC94073YC6	—	73P		•	•	SC-70-6
—	MIC94070YMT	—	P70	•			1.2mm x 1.6mm Thin MLF <sup>®</sup>
—	MIC94071YMT	—	P71	•		•	1.2mm x 1.6mm Thin MLF <sup>®</sup>
—	MIC94072YMT	—	P72		•		1.2mm x 1.6mm Thin MLF <sup>®</sup>
—	MIC94073YMT	—	P73		•	•	1.2mm x 1.6mm Thin MLF <sup>®</sup>

### Notes

- Under-bar symbol on SC-70 Pb-free packages may not be to scale.

## Pin Configuration

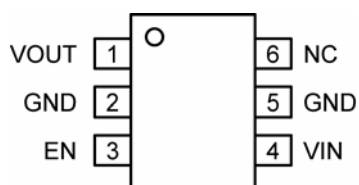

SC-70-6 (C6)

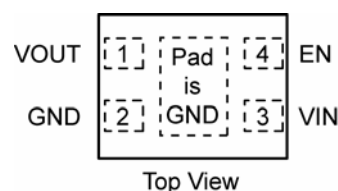

Top View

1.2x1.6 mm Thin MLF<sup>®</sup> (MT)

## Pin Description

Pin Number		Pin Name	Pin Function
SC-70	MLF		
1	1	V <sub>OUT</sub>	Drain of P-channel MOSFET.
2,5	2	GND	Ground and the backside pad (MLF only) should both be connected to electrical ground.
4	3	V <sub>IN</sub>	Source of P-channel MOSFET.
3	4	EN	Enable (Input): Active-high CMOS compatible control input for switch A. Do not leave floating.
6	--	NIC	No Internal Connection. A signal or voltage applied to this pin will have no effect on device operation.

[查询"MIC94070"供应商](#)**Absolute Maximum Ratings** <sup>(1)</sup>

Input Voltage ( $V_{IN}$ ).....	+6V
Enable Voltage ( $V_{EN}$ ) .....	+6V
Continuous Drain Current ( $I_D$ ) <sup>(3)</sup>	
$T_A = 25^\circ\text{C}$ (MLF <sup>®</sup> ) .....	$\pm 1.2\text{A}$
$T_A = 25^\circ\text{C}$ (SC-70) .....	$\pm 1.2\text{A}$
Pulsed Drain Current ( $I_{DP}$ ) <sup>(4)</sup> .....	$\pm 3.0\text{A}$
Continuous Diode Current ( $I_S$ ) <sup>(4)</sup> .....	-50mA
Storage Temperature ( $T_S$ ).....	-55°C to +150°C
ESD Rating – HBM <sup>(6)</sup> .....	4KV

**Operating Ratings** <sup>(2)</sup>

Input Voltage ( $V_{IN}$ ) .....	+1.7 to +5.5V
Junction Temperature ( $T_J$ ).....	-40°C to +125°C
Package Thermal Resistance	
SC-70-6 ( $\theta_{JA}$ ) .....	240°C/W
1.2mm x 1.6mm MLF <sup>®</sup> ( $\theta_{JA}$ ).....	172°C/W
1.2mm x 1.6mm MLF <sup>®</sup> ( $\theta_{JC}$ ) <sup>(3)</sup> .....	134°C/W

**Electrical Characteristics**

$T_A = 25^\circ\text{C}$ , bold values indicate  $-40^\circ\text{C} \leq T_A \leq +85^\circ\text{C}$ , unless noted.

Symbol	Parameter	Condition	Min	Typ	Max	Units
$V_{EN\_TH}$	Enable Threshold Voltage	$V_{IN} = 1.8\text{V to } 4.5\text{V}, I_D = -250\mu\text{A}$	0.5		1.2	V
		$V_{IN} = 1.7\text{V to } 4.5\text{V}, I_D = -250\mu\text{A}$	0.4		1.2	V
$I_Q$	Supply Current	$V_{IN} = V_{EN} = 5.5\text{V}, I_D = \text{OPEN}$ Measured on the $V_{IN}$ pin (7)		50nA	5	$\mu\text{A}$
$I_{EN}$	Enable Input Current	$V_{IN} = V_{EN} = 5.5\text{V}, I_D = \text{OPEN}$		2	4	$\mu\text{A}$
$I_{SHUT-Q}$	Shutdown Current	$V_{IN} = +5.5\text{V}, V_{EN} = 0\text{V}, I_D = \text{OPEN}$ Measured on the $V_{IN}$ pin (7)		25nA	1	$\mu\text{A}$
$I_{SHUT-SWITCH}$	OFF State Leakage Current	$V_{IN} = +5.5\text{V}, V_{EN} = 0\text{V}, I_D = \text{SHORT}$ Measured on $V_{OUT}$ (7)		50nA	1	$\mu\text{A}$
$R_{DS(ON)}$	P-Channel Drain to Source ON Resistance	$V_{IN} = +5.0\text{V}, I_D = -100\text{mA}, V_{EN} = 1.5\text{V}$		120	170	m $\Omega$
		$V_{IN} = +4.5\text{V}, I_D = -100\text{mA}, V_{EN} = 1.5\text{V}$		130	185	m $\Omega$
		$V_{IN} = +3.6\text{V}, I_D = -100\text{mA}, V_{EN} = 1.5\text{V}$		145	210	m $\Omega$
		$V_{IN} = +2.5\text{V}, I_D = -100\text{mA}, V_{EN} = 1.5\text{V}$		165	225	m $\Omega$
		$V_{IN} = +1.8\text{V}, I_D = -100\text{mA}, V_{EN} = 1.5\text{V}$		200	260	m $\Omega$
		$V_{IN} = +1.7\text{V}, I_D = -100\text{mA}, V_{EN} = 1.5\text{V}$		210	285	m $\Omega$
$R_{DS(ON)}$	P-Channel Drain to Source ON Resistance	$V_{IN} = +5.0\text{V}, I_D = -100\text{mA}, V_{EN} = 1.5\text{V}$		100	160	m $\Omega$
		$V_{IN} = +4.5\text{V}, I_D = -100\text{mA}, V_{EN} = 1.5\text{V}$		110	165	m $\Omega$
		$V_{IN} = +3.6\text{V}, I_D = -100\text{mA}, V_{EN} = 1.5\text{V}$		125	180	m $\Omega$
		$V_{IN} = +2.5\text{V}, I_D = -100\text{mA}, V_{EN} = 1.5\text{V}$		145	200	m $\Omega$
		$V_{IN} = +1.8\text{V}, I_D = -100\text{mA}, V_{EN} = 1.5\text{V}$		180	240	m $\Omega$
		$V_{IN} = +1.7\text{V}, I_D = -100\text{mA}, V_{EN} = 1.5\text{V}$		190	265	m $\Omega$
$R_{SHUTDOWN}$	Turn-Off Resistance	$V_{IN} = +3.6\text{V}, I_{TEST} = 1\text{mA}, V_{EN} = 0\text{V}$ MIC94071, 73		200	400	$\Omega$

[查询"MIC94070"供应商](#)

## Electrical Characteristics (Dynamic)

$V_{IN} = 5V$ ;  $T_A = 25^\circ C$ , bold values indicate  $-40^\circ C \leq T_A \leq +85^\circ C$ , unless noted.

Symbol	Parameter	Condition	Min	Typ	Max	Units
$t_{ON\_DLY}$	Turn-On Delay Time	$V_{IN} = +3.6V$ , $I_D = -100mA$ , $V_{EN} = 1.5V$ MIC94070, 71		0.85	1.5	$\mu s$
		$V_{IN} = +3.6V$ , $I_D = -100mA$ , $V_{EN} = 1.5V$ MIC94072, 73		700	1200	$\mu s$
$t_{ON\_RISE}$	Turn-On Rise Time	$V_{IN} = +3.6V$ , $I_D = -100mA$ , $V_{EN} = 1.5V$ MIC94070, 71	0.5	1	5	$\mu s$
		$V_{IN} = +3.6V$ , $I_D = -100mA$ , $V_{EN} = 1.5V$ MIC94072, 73	500	800	1500	$\mu s$

$t_{OFF\_DLY}$	Turn-Off Delay Time	$V_{IN} = +3.6V$ , $I_D = -100mA$ , $V_{EN} = 1.5V$ MIC94070, 71		100	200	ns
		$V_{IN} = +3.6V$ , $I_D = -100mA$ , $V_{EN} = 1.5V$ MIC94072, 73		60	200	ns
$t_{OFF\_FALL}$	Turn-Off Fall Time	$V_{IN} = +3.6V$ , $I_D = -100mA$ , $V_{EN} = 1.5V$ MIC94070, 71		60	100	ns
		$V_{IN} = +3.6V$ , $I_D = -100mA$ , $V_{EN} = 1.5V$ MIC94072, 73		60	100	ns

### Notes:

1. Exceeding the absolute maximum rating may damage the device.
2. The device is not guaranteed to function outside its operating rating.
3. With backside thermal contact to PCB.
4. Pulse width  $< 300\mu s$  with  $< 2\%$  duty cycle.
5. Continuous body diode current conduction (reverse conduction, i.e.  $V_{OUT}$  to  $V_{IN}$ ) is not recommended.
6. Devices are ESD sensitive. Handling precautions recommended. HBM (Human body model), 1.5k in series with 100pF.
7. Measured on the MIC94070YMT, for other part numbers, please contact Micrel.

[查询"MIC94070"供应商](#)

## Typical Characteristics

**RDS-On Variance with Temperature**

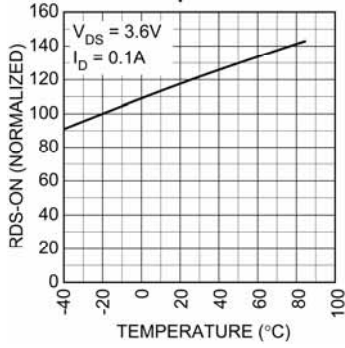

**EN Threshold Voltage vs. Input Voltage**

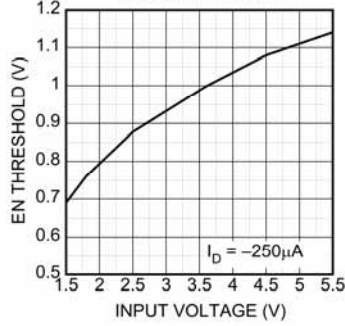

**On Resistance vs. Input Voltage**

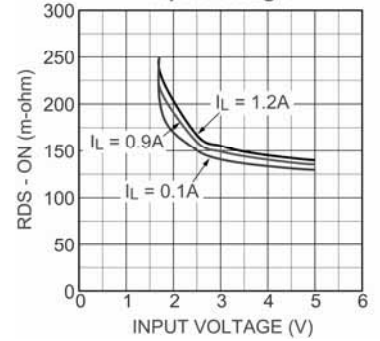

**Voltage Drop vs. Load Current**

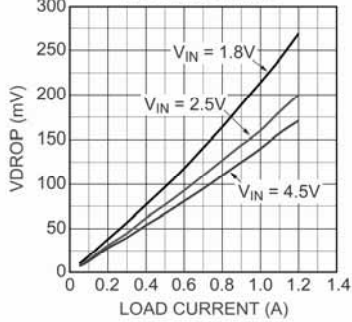

**MIC94070/71 Turn-On Delay vs. Input Voltage**

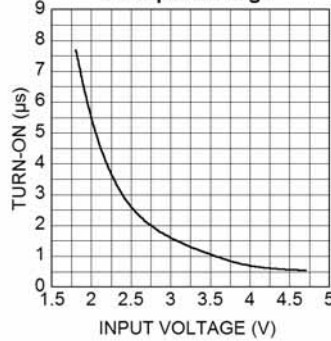

**MIC94070/71 Rise Time vs. Input Voltage**

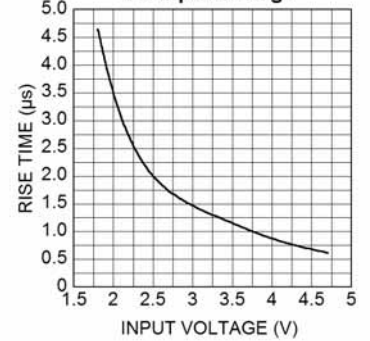

**MIC94070/71 Turn-Off Delay vs. Input Voltage**

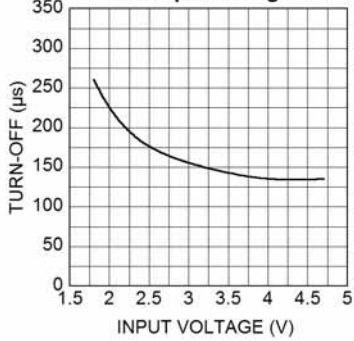

**MIC94070/71 Fall Time vs. Input Voltage**

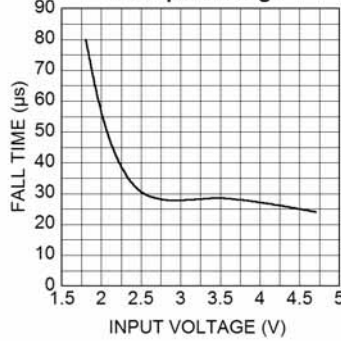

**MIC94072/73 Turn-On Delay vs. Input Voltage**

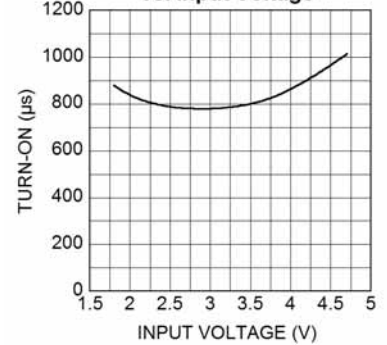

**MIC94072/73 Rise Time vs. Input Voltage**

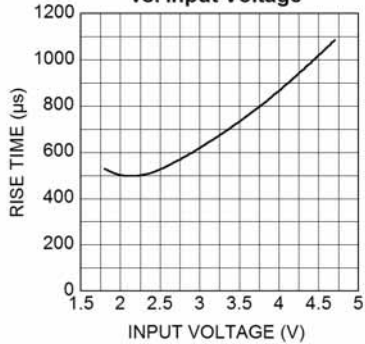

**MIC94072/73 Turn-Off Delay vs. Input Voltage**

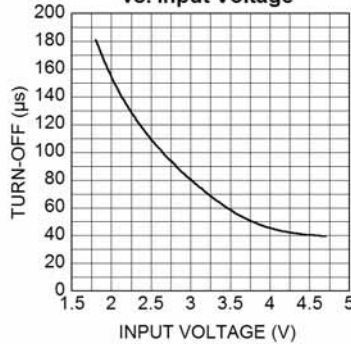

**MIC94072/73 Fall Time vs. Input Voltage**

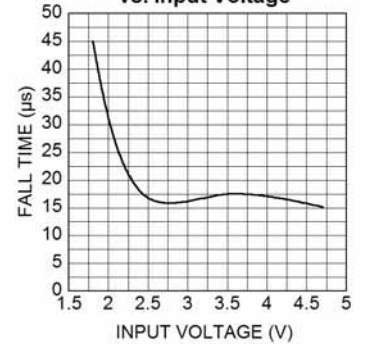

[查询"MIC94070"供应商](#)

# Functional Characteristics

## MIC94070

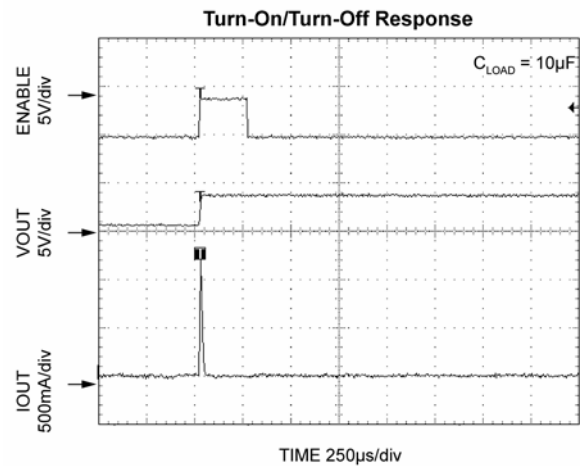
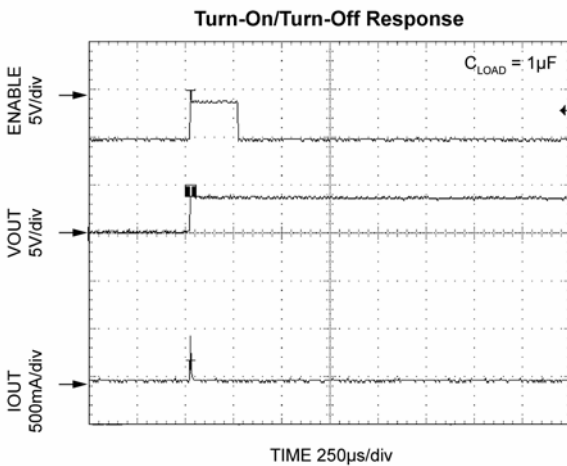
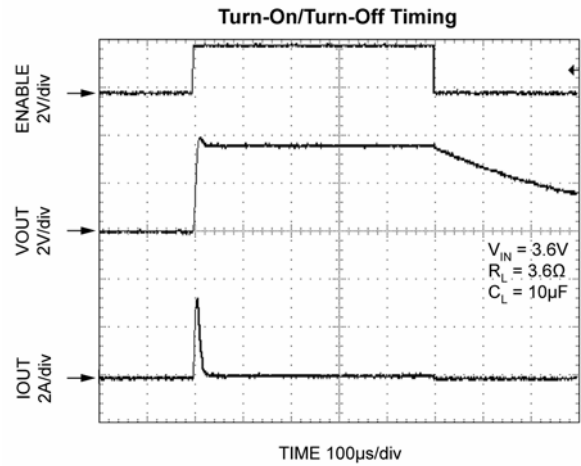
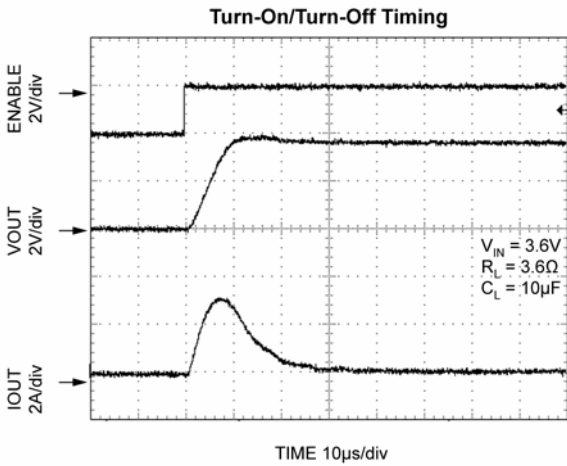
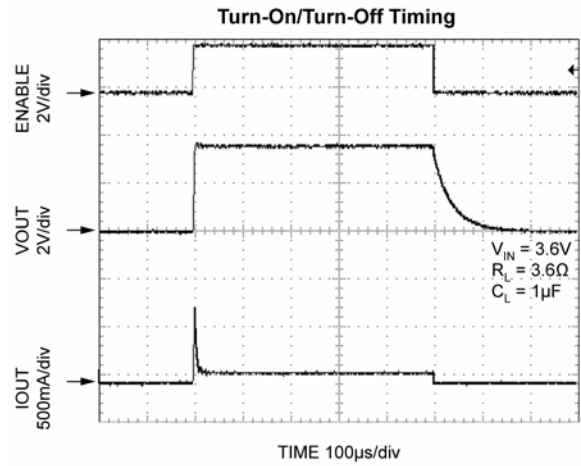
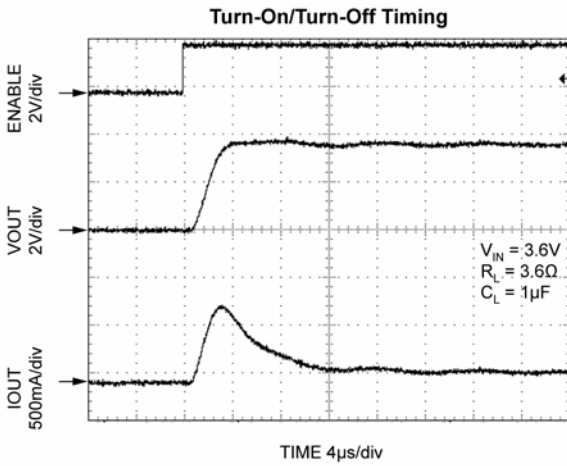



[查询"MIC94070"供应商](#)

# MIC94071

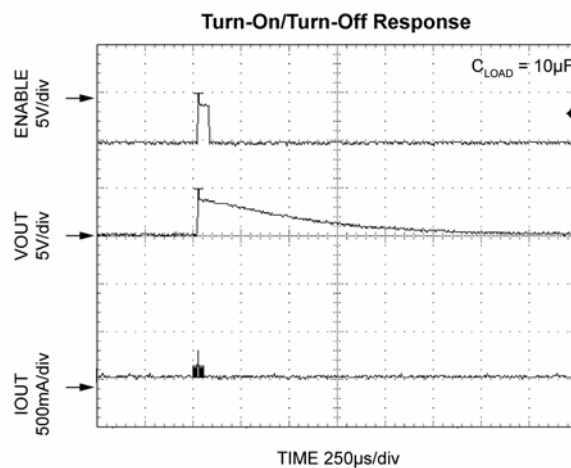
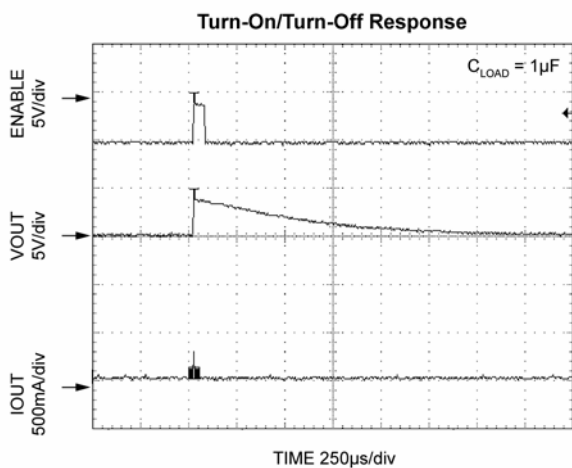
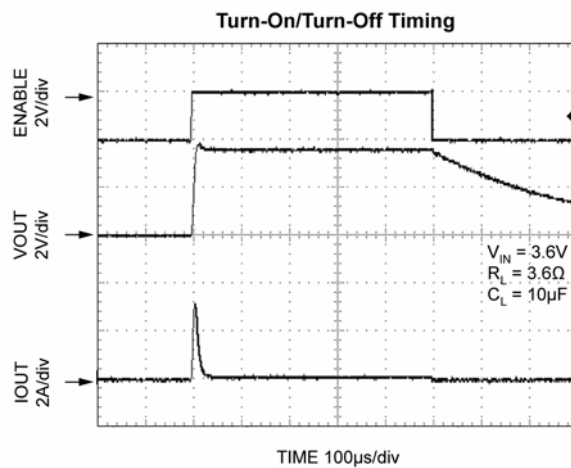
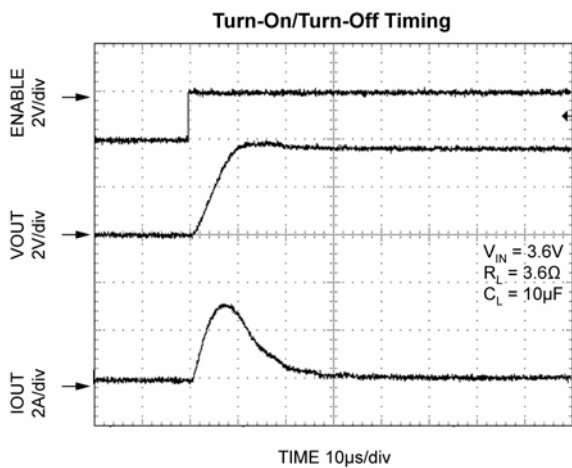
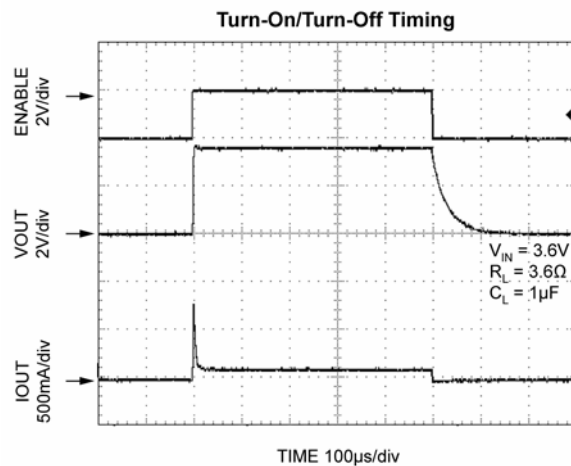
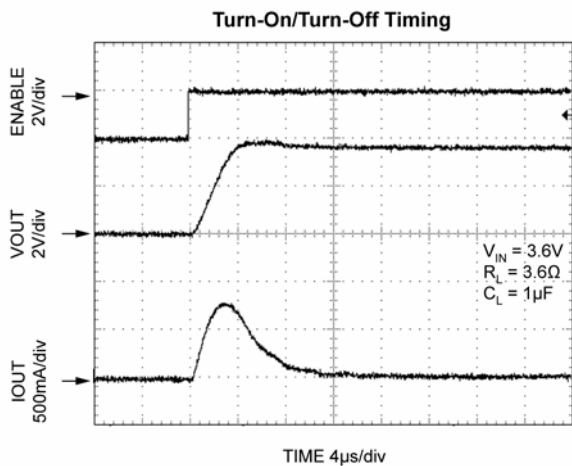

[查询"MIC94070"供应商](#)

# MIC94072

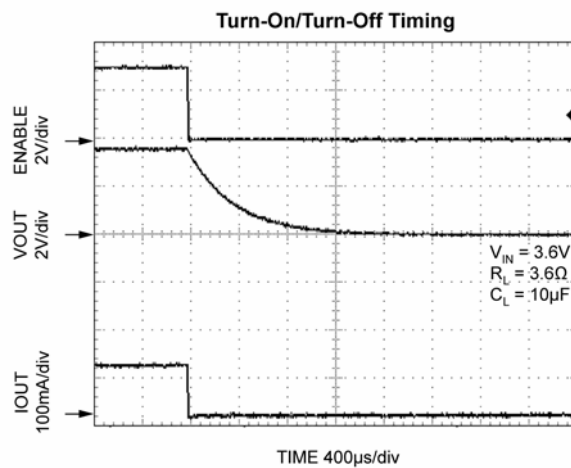
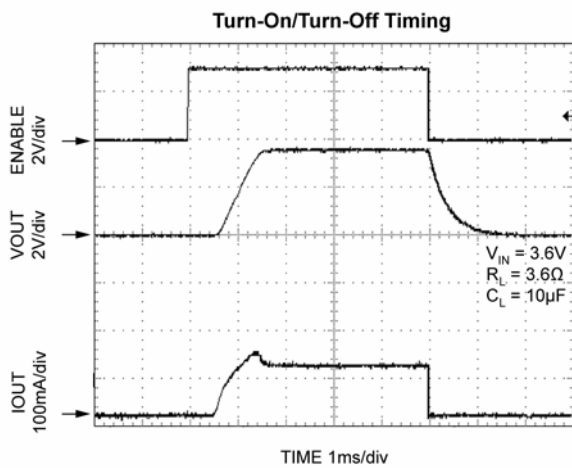
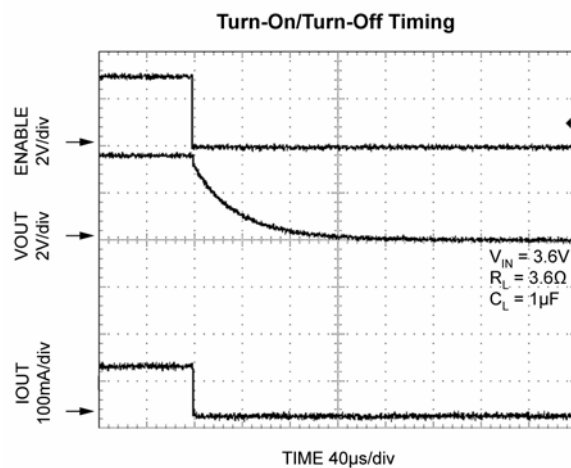
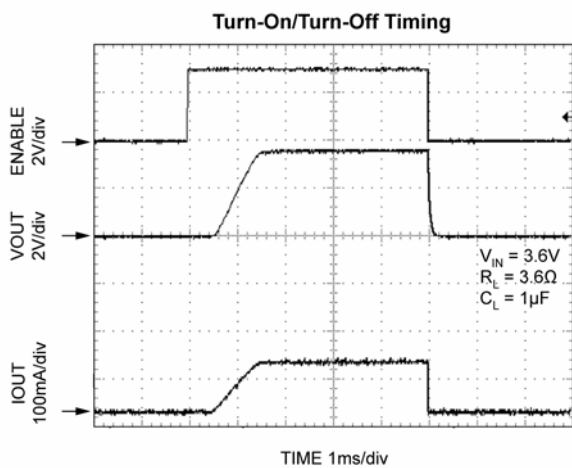



[查询"MIC94070"供应商](#)

**MIC94073**

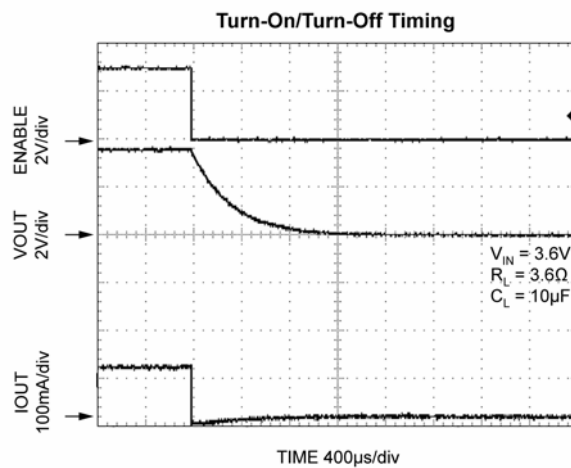
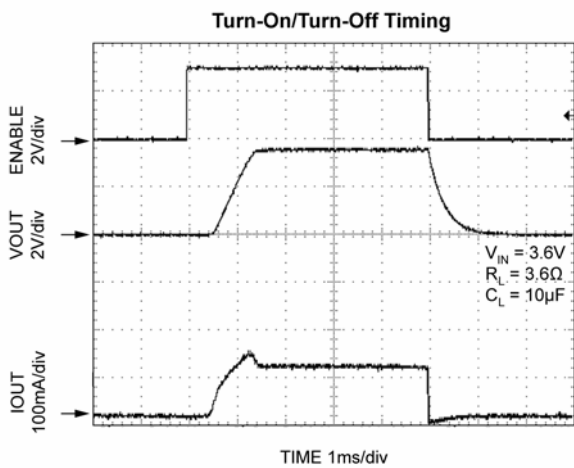
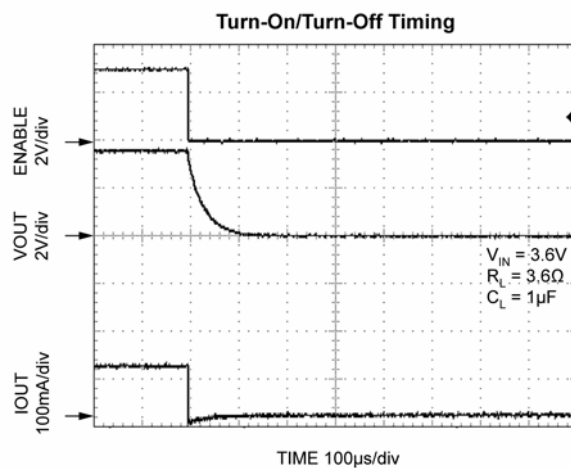
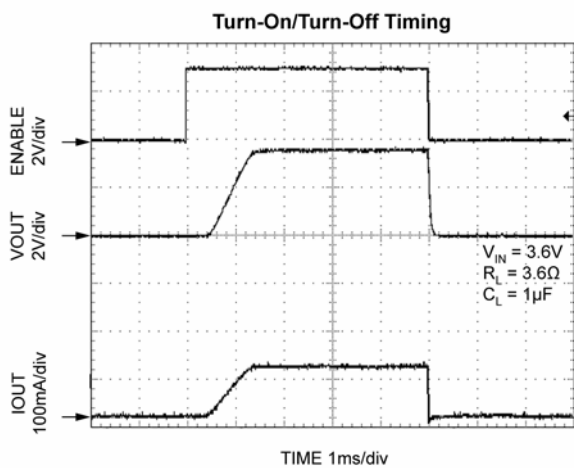

[查询"MIC94070"供应商](#)

**Package Information**

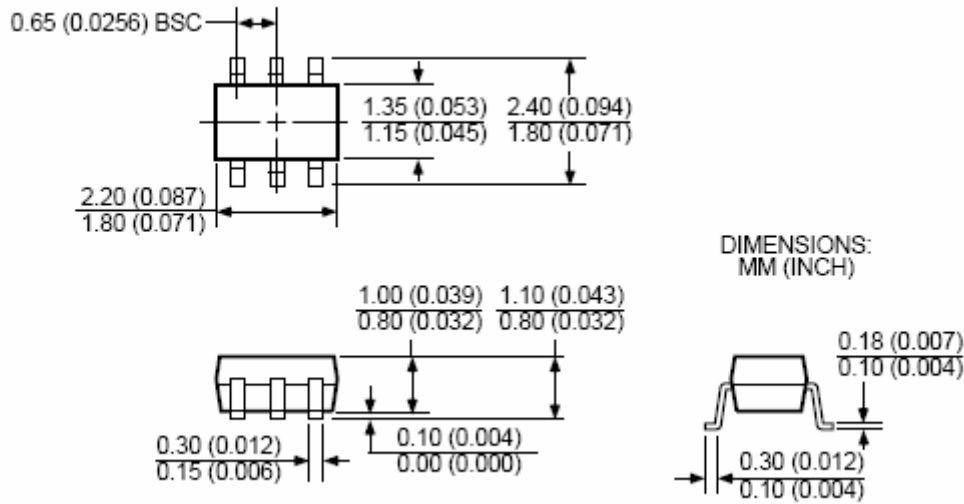

**6-Pin SC-70 (C6)**

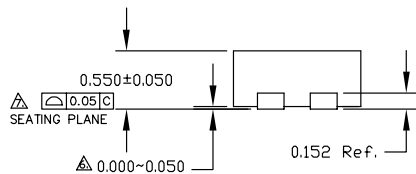
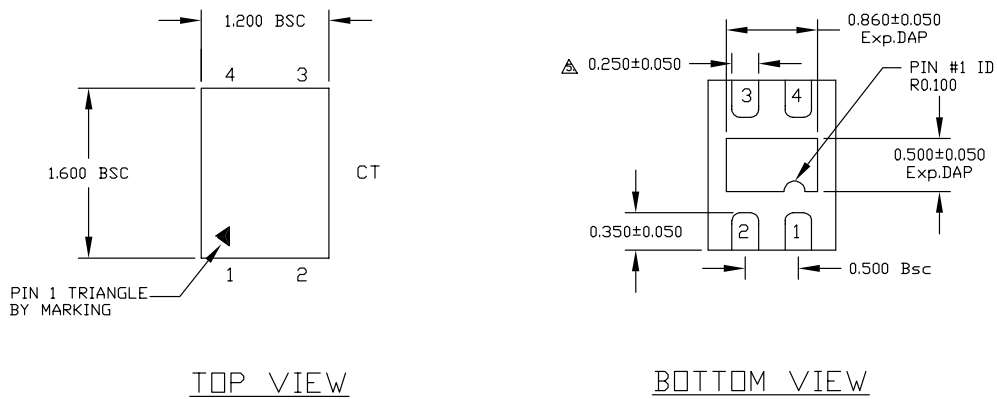

- NOTE:
1. ALL DIMENSIONS ARE IN MILLIMETERS.
  2. MAX. PACKAGE WARPAGE IS 0.05 mm.
  3. MAXIMUM ALLOWABLE BURRS IS 0.076 mm IN ALL DIRECTIONS.
  4. PIN #1 ID ON TOP WILL BE LASER/INK MARKED.
- △ DIMENSION APPLIES TO METALIZED TERMINAL AND IS MEASURED BETWEEN 0.20 AND 0.25 mm FROM TERMINAL TIP.
- △ APPLIED ONLY FOR TERMINALS.
- △ APPLIED FOR EXPOSED PAD AND TERMINALS.

**4-Pin Thin MLF® (MT)**

[查询"MIC94070"供应商](#)

**Recommended Land Pattern for MLF 1.2x1.6 4 Lead**

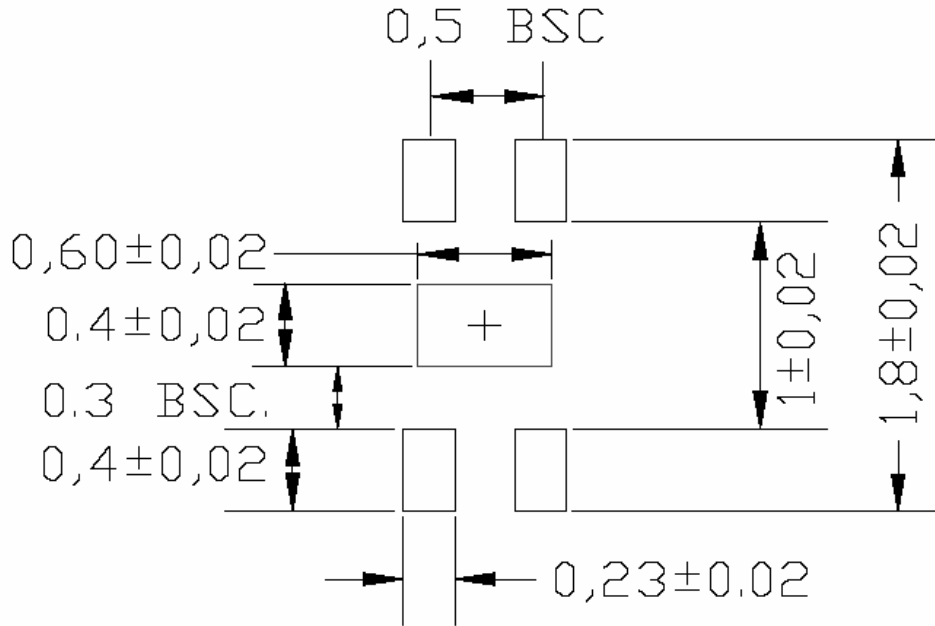

Optional for maximum thermal performance. Heatsink should be connected to GND plane of PCB for maximum thermal performance.

Disclaimer: This is only a recommendation based on information available to Micrel from its suppliers. Actual land pattern may have to be significantly different due to various materials and processes used in PCB assembly. Micrel makes no representation or warranty of performance based on the recommended land pattern."

**MICREL, INC. 2180 FORTUNE DRIVE SAN JOSE, CA 95131 USA**  
 TEL +1 (408) 944-0800 FAX +1 (408) 474-1000 WEB <http://www.micrel.com>

The information furnished by Micrel in this data sheet is believed to be accurate and reliable. However, no responsibility is assumed by Micrel for its use. Micrel reserves the right to change circuitry and specifications at any time without notification to the customer.

Micrel Products are not designed or authorized for use as components in life support appliances, devices or systems where malfunction of a product can reasonably be expected to result in personal injury. Life support devices or systems are devices or systems that (a) are intended for surgical implant into the body or (b) support or sustain life, and whose failure to perform can be reasonably expected to result in a significant injury to the user. A Purchaser's use or sale of Micrel Products for use in life support appliances, devices or systems is a Purchaser's own risk and Purchaser agrees to fully indemnify Micrel for any damages resulting from such use or sale.

© 2007 Micrel, Incorporated.