

## N-Channel 100-V (D-S) MOSFET

## PRODUCT SUMMARY

| V <sub>DS</sub> (V) | R <sub>DS(on)</sub> (Ω)         | I <sub>D</sub> (A) <sup>a</sup> | Q <sub>g</sub> (Typ.) |
|---------------------|---------------------------------|---------------------------------|-----------------------|
| 100                 | 0.058 at V <sub>GS</sub> = 10 V | 18                              | 13 nC                 |

PowerPAK® 1212-8

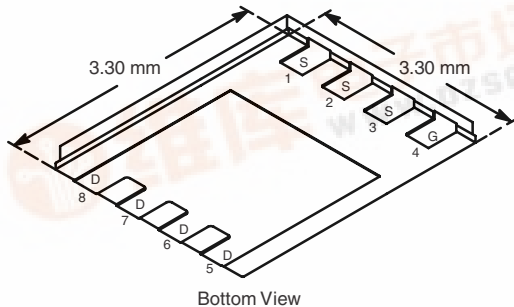

Bottom View

Ordering Information: SI7322DN-T1-E3 (Lead (Pb)-free)  
SI7322DN-T1-GE3 (Lead (Pb)-free and Halogen-free)

## FEATURES

- Halogen-free Option Available
- TrenchFET® Power MOSFET
- 100 % UIS Tested

RoHS  
COMPLIANT

## APPLICATIONS

- Primary Switch
- Isolated DC/DC Converters

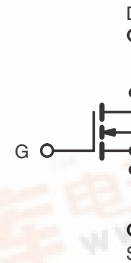

N-Channel MOSFET

ABSOLUTE MAXIMUM RATINGS T<sub>A</sub> = 25 °C, unless otherwise noted

| Parameter  | Symbol                            | Limit                  | Unit                |
|--|-----------------------------------|------------------------|---------------------|
| Drain-Source Voltage   | V <sub>DS</sub>                   | 100                    | V                   |
| Gate-Source Voltage  | V <sub>GS</sub>                   | ± 20                   |                     |
| Continuous Drain Current (T <sub>J</sub> = 150 °C)           | I <sub>D</sub>                    | T <sub>C</sub> = 25 °C | 18 <sup>a</sup>     |
|  |                                   | T <sub>C</sub> = 70 °C | 16 <sup>a</sup>     |
|  |                                   | T <sub>A</sub> = 25 °C | 5.5 <sup>b, c</sup> |
|  |                                   | T <sub>A</sub> = 70 °C | 4.4 <sup>b, c</sup> |
| Pulsed Drain Current   | I <sub>DM</sub>                   | 20                     | A                   |
| Continuous Source-Drain Diode Current                        | I <sub>S</sub>                    | T <sub>C</sub> = 25 °C | 18 <sup>a</sup>     |
|  |                                   | T <sub>A</sub> = 25 °C | 3.2 <sup>b, c</sup> |
| Single Pulse Avalanche Current                               | I <sub>AS</sub>                   | 19                     |                     |
| Single Pulse Avalanche Energy                                | E <sub>AS</sub>                   | 18                     | mJ                  |
| Maximum Power Dissipation                                    | P <sub>D</sub>                    | T <sub>C</sub> = 25 °C | 52                  |
|  |                                   | T <sub>C</sub> = 70 °C | 33                  |
|  |                                   | T <sub>A</sub> = 25 °C | 3.8 <sup>b, c</sup> |
|  |                                   | T <sub>A</sub> = 70 °C | 2.4 <sup>b, c</sup> |
| Operating Junction and Storage Temperature Range             | T <sub>J</sub> , T <sub>stg</sub> | - 55 to 150            | °C                  |
| Soldering Recommendations (Peak Temperature) <sup>d, e</sup> |                                   | 260                    |                     |

## THERMAL RESISTANCE RATINGS

| Parameter                                   | Symbol            | Typical | Maximum | Unit |
|---|-------------------|---------|---------|------|
| Maximum Junction-to-Ambient <sup>b, f</sup> | R <sub>thJA</sub> | 26      | 33      | °C/W |
| Maximum Junction-to-Case (Drain)            | R <sub>thJC</sub> | 1.9     | 2.4     |      |

Notes:

- Package limited
- Surface Mounted on 1" x 1" FR4 board.
- t = 10 s.
- See Solder Profile (<http://www.vishay.com/ppg?73257>). The PowerPAK 1212-8 is a leadless package. The end of the lead terminal is exposed copper (not plated) as a result of the singulation process in manufacturing. A solder fillet at the exposed copper tip cannot be guaranteed and is not required to ensure adequate bottom side solder interconnection.
- Rework conditions: manual soldering with a soldering iron is not recommended for leadless components.
- Maximum under Steady State conditions is 81 °C/W.

| SPECIFICATIONS $T_J = 25\text{ }^\circ\text{C}$ , unless otherwise noted |                         |  |      |       |           |               |
|--|-------------------------|--|------|-------|-----------|---------------|
| Parameter  | Symbol                  | Test Conditions  | Min. | Typ.  | Max.      | Unit          |
| <b>Static</b>  |                         |  |      |       |           |               |
| Drain-Source Breakdown Voltage   | $V_{DS}$                | $V_{GS} = 0\text{ V}, I_D = 250\text{ }\mu\text{A}$  | 100  |       |           | V             |
| $V_{DS}$ Temperature Coefficient   | $\Delta V_{DS}/T_J$     | $I_D = 250\text{ }\mu\text{A}$   |      | 130   |           | mV/°C         |
| $V_{GS(th)}$ Temperature Coefficient                                     | $\Delta V_{GS(th)}/T_J$ |  |      | - 10  |           |               |
| Gate-Source Threshold Voltage  | $V_{GS(th)}$            | $V_{DS} = V_{GS}, I_D = 250\text{ }\mu\text{A}$  | 2.5  |       | 4.4       | V             |
| Gate-Source Leakage  | $I_{GSS}$               | $V_{DS} = 0\text{ V}, V_{GS} = \pm 20\text{ V}$  |      |       | $\pm 100$ | nA            |
| Zero Gate Voltage Drain Current  | $I_{DSS}$               | $V_{DS} = 100\text{ V}, V_{GS} = 0\text{ V}$   |      |       | 1         | $\mu\text{A}$ |
|  |                         | $V_{DS} = 100\text{ V}, V_{GS} = 0\text{ V}, T_J = 55\text{ }^\circ\text{C}$   |      |       | 10        |               |
| On-State Drain Current <sup>a</sup>                                      | $I_{D(on)}$             | $V_{DS} \geq 5\text{ V}, V_{GS} = 10\text{ V}$   | 20   |       |           | A             |
| Drain-Source On-State Resistance <sup>a</sup>                            | $R_{DS(on)}$            | $V_{GS} = 10\text{ V}, I_D = 5.5\text{ A}$   |      | 0.048 | 0.058     | $\Omega$      |
| Forward Transconductance <sup>a</sup>                                    | $g_{fs}$                | $V_{DS} = 15\text{ V}, I_D = 5.5\text{ A}$   |      | 10    |           | S             |
| <b>Dynamic<sup>b</sup></b>   |                         |  |      |       |           |               |
| Input Capacitance  | $C_{iss}$               | $V_{DS} = 50\text{ V}, V_{GS} = 0\text{ V}, f = 1\text{ MHz}$  |      | 750   |           | pF            |
| Output Capacitance   | $C_{oss}$               |  |      | 80    |           |               |
| Reverse Transfer Capacitance   | $C_{rss}$               |  |      | 25    |           |               |
| Total Gate Charge  | $Q_g$                   | $V_{DS} = 50\text{ V}, V_{GS} = 10\text{ V}, I_D = 5.5\text{ A}$   |      | 13    | 20        | nC            |
| Gate-Source Charge   | $Q_{gs}$                |  |      | 3.7   |           |               |
| Gate-Drain Charge  | $Q_{gd}$                |  |      | 3     |           |               |
| Gate Resistance  | $R_g$                   | $f = 1\text{ MHz}$   |      | 1.3   |           | $\Omega$      |
| Turn-On Delay Time   | $t_{d(on)}$             | $V_{DD} = 50\text{ V}, R_L = 11.4\text{ }\Omega$<br>$I_D \cong 4.4\text{ A}, V_{GEN} = 10\text{ V}, R_g = 1\text{ }\Omega$ |      | 10    | 15        | ns            |
| Rise Time  | $t_r$                   |  |      | 10    | 15        |               |
| Turn-Off Delay Time  | $t_{d(off)}$            |  |      | 12    | 20        |               |
| Fall Time  | $t_f$                   |  |      | 10    | 15        |               |
| <b>Drain-Source Body Diode Characteristics</b>                           |                         |  |      |       |           |               |
| Continuous Source-Drain Diode Current                                    | $I_S$                   | $T_C = 25\text{ }^\circ\text{C}$   |      |       | 18        | A             |
| Pulse Diode Forward Current  | $I_{SM}$                |  |      |       | 20        |               |
| Body Diode Voltage   | $V_{SD}$                | $I_S = 4.4\text{ A}, V_{GS} = 0\text{ V}$  |      | 0.8   | 1.2       | V             |
| Body Diode Reverse Recovery Time   | $t_{rr}$                | $I_F = 4.4\text{ A}, di/dt = 100\text{ A}/\mu\text{s}, T_J = 25\text{ }^\circ\text{C}$                                     |      | 40    | 60        | ns            |
| Body Diode Reverse Recovery Charge                                       | $Q_{rr}$                |  |      | 70    | 105       | nC            |
| Reverse Recovery Fall Time   | $t_a$                   |  |      | 30    |           | ns            |
| Reverse Recovery Rise Time   | $t_b$                   |  |      | 10    |           |               |

## Notes:

- a. Pulse test; pulse width  $\leq 300\text{ }\mu\text{s}$ , duty cycle  $\leq 2\%$   
b. Guaranteed by design, not subject to production testing.

Stresses beyond those listed under "Absolute Maximum Ratings" may cause permanent damage to the device. These are stress ratings only, and functional operation of the device at these or any other conditions beyond those indicated in the operational sections of the specifications is not implied. Exposure to absolute maximum rating conditions for extended periods may affect device reliability.

**TYPICAL CHARACTERISTICS** 25 °C, unless otherwise noted

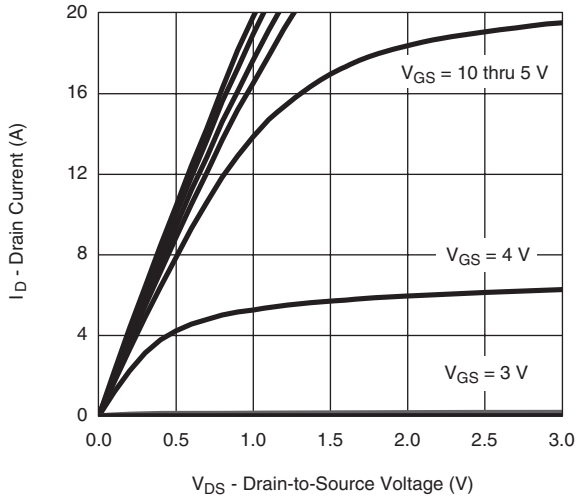

**Output Characteristics**

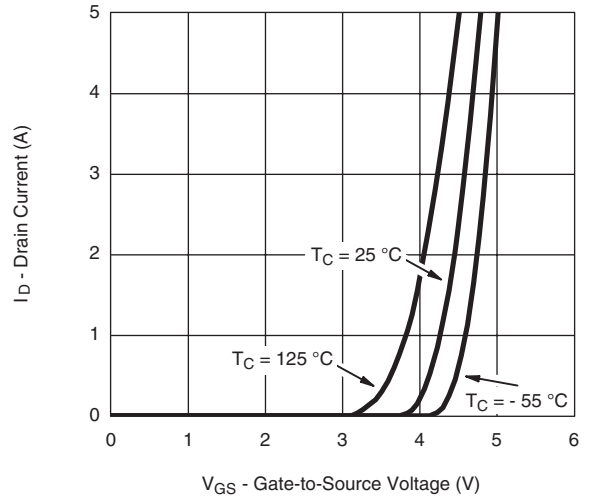

**Transfer Characteristics**

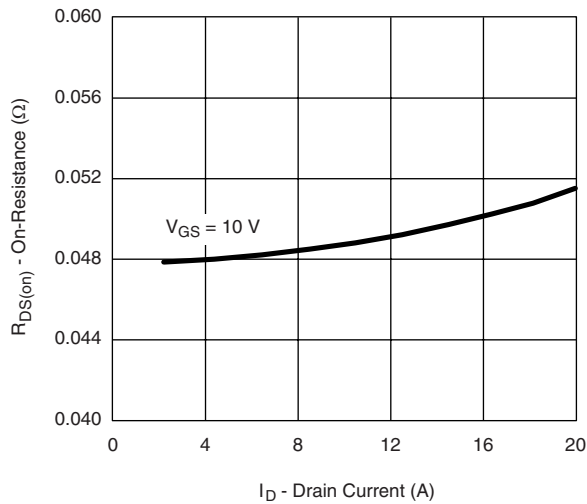

**On-Resistance vs. Drain Current and Gate Voltage**

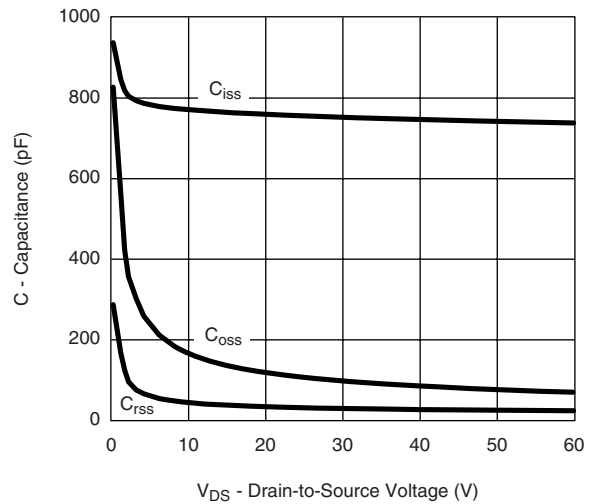

**Capacitance**

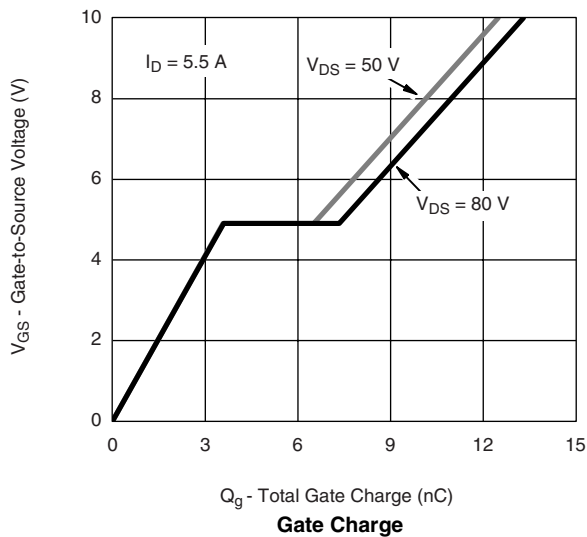

**Gate Charge**

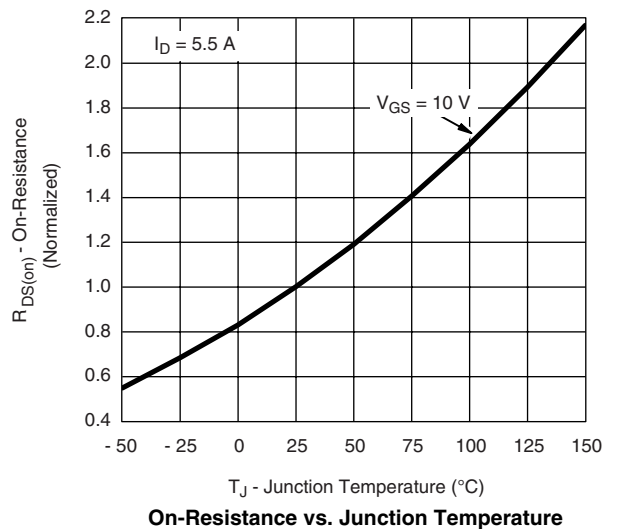

**On-Resistance vs. Junction Temperature**

# Si7322DN



上海Si7322DN代理商  
Vishay Siliconix

## TYPICAL CHARACTERISTICS 25 °C, unless otherwise noted

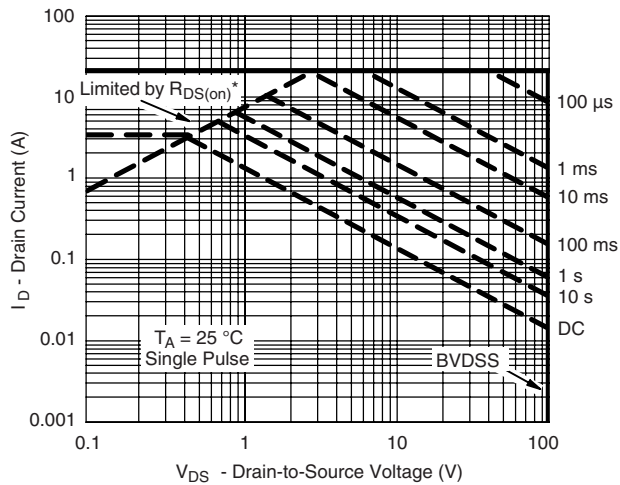
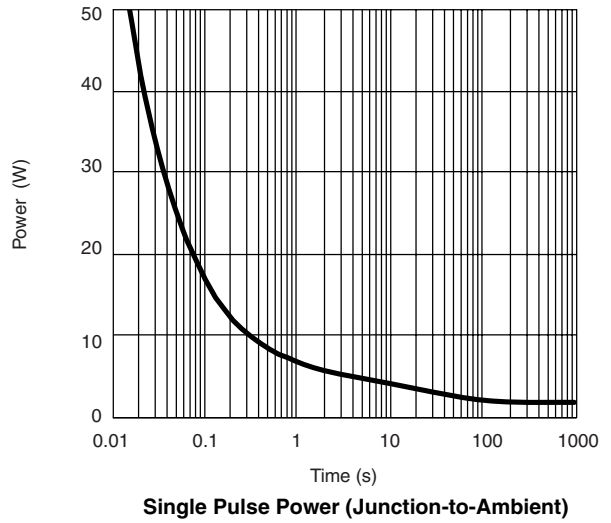
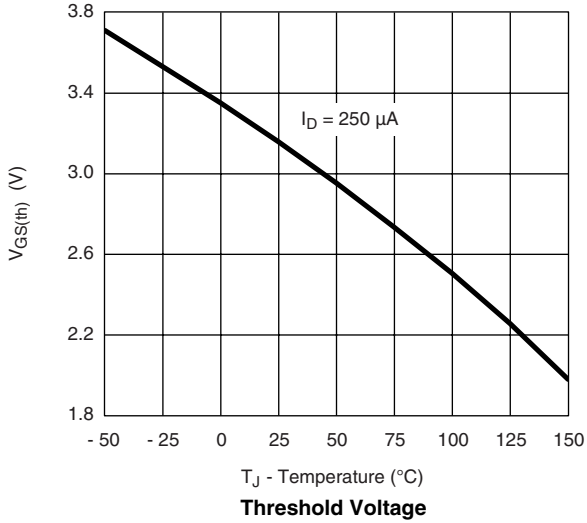
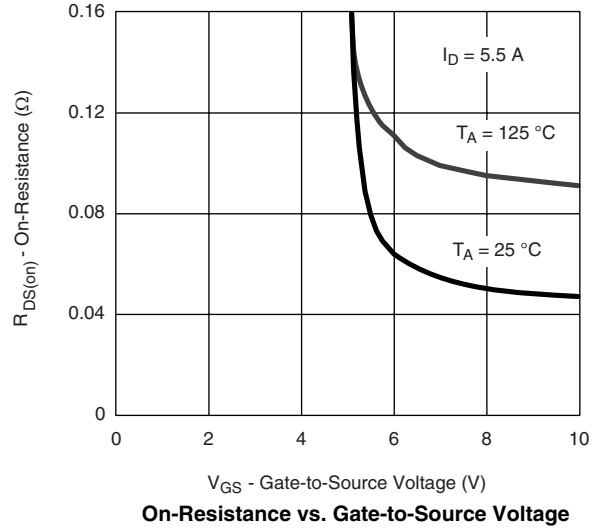
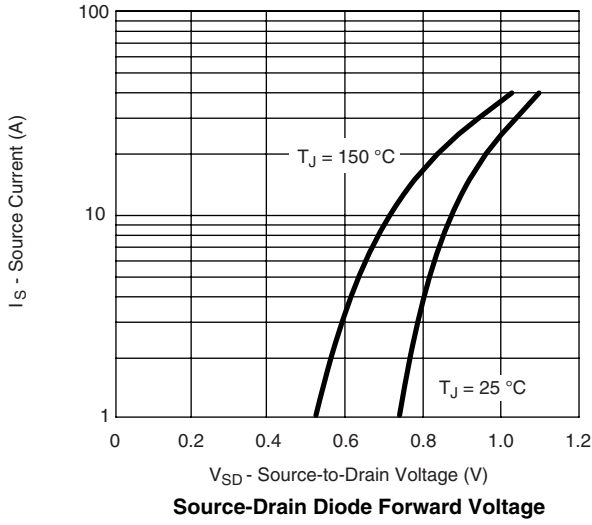

\*  $V_{GS} >$  minimum  $V_{GS}$  at which  $R_{DS(on)}$  is specified

### Safe Operating Area, Junction-to-Ambient



**TYPICAL CHARACTERISTICS** 25 °C, unless otherwise noted

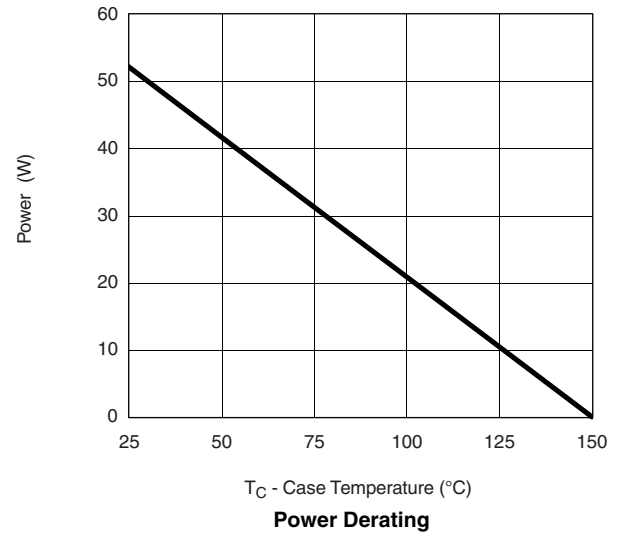
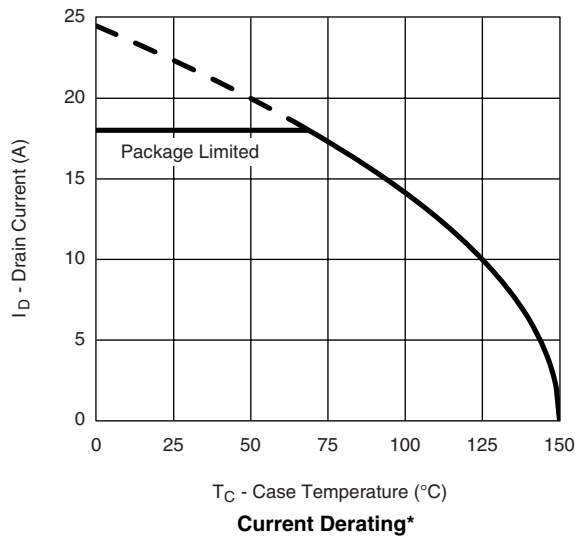

\* The power dissipation  $P_D$  is based on  $T_{J(max)} = 150$  °C, using junction-to-case thermal resistance, and is more useful in settling the upper dissipation limit for cases where additional heatsinking is used. It is used to determine the current rating, when this rating falls below the package limit.

Si7322DN



Vishay Siliconix 供应商

**TYPICAL CHARACTERISTICS** 25 °C, unless otherwise noted

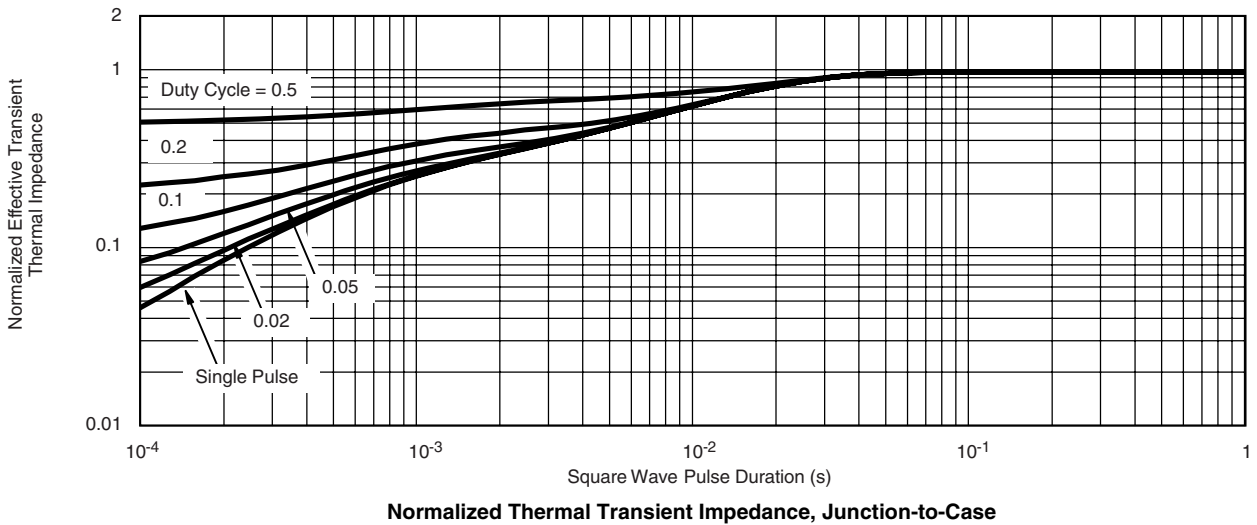
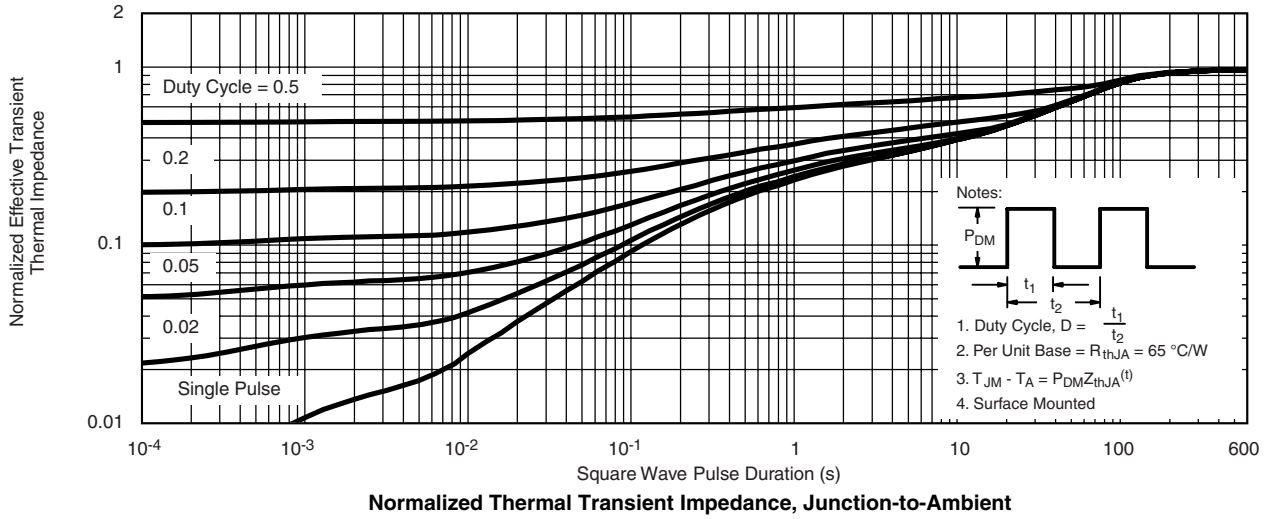

Vishay Siliconix maintains worldwide manufacturing capability. Products may be manufactured at one of several qualified locations. Reliability data for Silicon Technology and Package Reliability represent a composite of all qualified locations. For related documents such as package/tape drawings, part marking, and reliability data, see <http://www.vishay.com/ppg?69638>.

## Disclaimer

All product specifications and data are subject to change without notice.

Vishay Intertechnology, Inc., its affiliates, agents, and employees, and all persons acting on its or their behalf (collectively, "Vishay"), disclaim any and all liability for any errors, inaccuracies or incompleteness contained herein or in any other disclosure relating to any product.

Vishay disclaims any and all liability arising out of the use or application of any product described herein or of any information provided herein to the maximum extent permitted by law. The product specifications do not expand or otherwise modify Vishay's terms and conditions of purchase, including but not limited to the warranty expressed therein, which apply to these products.

No license, express or implied, by estoppel or otherwise, to any intellectual property rights is granted by this document or by any conduct of Vishay.

The products shown herein are not designed for use in medical, life-saving, or life-sustaining applications unless otherwise expressly indicated. Customers using or selling Vishay products not expressly indicated for use in such applications do so entirely at their own risk and agree to fully indemnify Vishay for any damages arising or resulting from such use or sale. Please contact authorized Vishay personnel to obtain written terms and conditions regarding products designed for such applications.

Product names and markings noted herein may be trademarks of their respective owners.