

# Dual Bus Driver/Receiver with 4-to-1 Output Multiplexers

## Description

The MC10H332 is a Dual Bus Driver/Receiver with four-to-one output multiplexers. These multiplexers have common selects and output enable. When disabled, ( $\overline{OE}$  = high) the bus outputs go to  $-2.0$  V. The parameters specified are with  $25 \Omega$  loading on the bus drivers and  $50 \Omega$  loads on the receivers.

## Features

- Propagation Delay, 1.5 ns Typical Data-to-Output
- Improved Noise Margin 150 mV (Over Operating Voltage and Temperature Range)
- Voltage Compensated
- MECL 10K™ Compatible
- Pb-Free Packages are Available\*

### DIP & PLLC PIN ASSIGNMENT

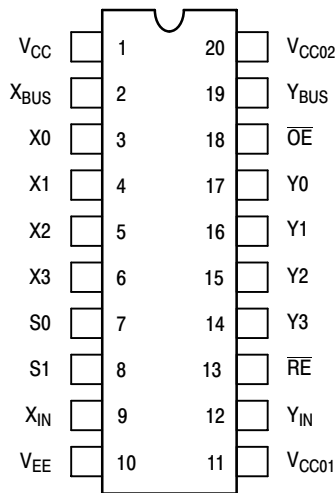

Pin assignment is for Dual-in-Line Package..

### NOTE:

Each MECL 10H series circuit has been designed to meet the dc specifications shown in the test table, after thermal equilibrium has been established. The circuit is in a test socket or mounted on a printed circuit board and transverse air flow greater than 500 lpm is maintained. Receiver outputs are terminated through a  $50 \Omega$  resistor to  $-2.0$  Vdc. Bus outputs are terminated through a  $25 \Omega$  resistor to  $-2.0$  Vdc.

\*For additional information on our Pb-Free strategy and soldering details, please download the ON Semiconductor Soldering and Mounting Techniques Reference Manual, SOLDERRM/D.



ON Semiconductor®

<http://onsemi.com>

## MARKING DIAGRAMS\*

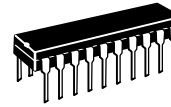

PDIP-20  
P SUFFIX  
CASE 738

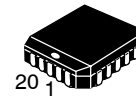

PLLC-20  
FN SUFFIX  
CASE 775

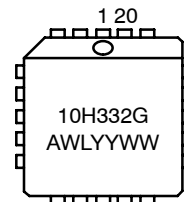

A = Assembly Location  
WL = Wafer Lot  
YY = Year  
WW = Work Week  
G = Pb-Free Package

\*For additional marking information, refer to Application Note AND8002/D.

## ORDERING INFORMATION

See detailed ordering and shipping information in the package dimensions section on page 3 of this data sheet.

# MC10H332

Table 1. MAXIMUM RATINGS 查词 MC10H332PNC 供应商

Symbol	Characteristic	Rating	Unit
V <sub>EE</sub>	Power Supply (V <sub>CC</sub> = 0)	-8.0 to 0	Vdc
V <sub>I</sub>	Input Voltage (V <sub>CC</sub> = 0)	0 to V <sub>EE</sub>	Vdc
I <sub>out</sub>	Output Current - Continuous - Surge	50 100	mA
T <sub>A</sub>	Operating Temperature Range	0 to +75	°C
T <sub>stg</sub>	Storage Temperature Range - Plastic - Ceramic	-55 to +150 -55 to +165	°C °C

Maximum ratings are those values beyond which device damage can occur. Maximum ratings applied to the device are individual stress limit values (not normal operating conditions) and are not valid simultaneously. If these limits are exceeded, device functional operation is not implied, damage may occur and reliability may be affected.

**Table 2. ELECTRICAL CHARACTERISTICS** (V<sub>EE</sub> = -5.2 V ±5%) (Note 1)

Symbol	Characteristic	0°		25°		75°		Unit
		Min	Max	Min	Max	Min	Max	
I <sub>E</sub>	Power Supply Current	-	115	-	110	-	115	mA
I <sub>inH</sub>	Input Current High Pins 3,4,5,6,14, 15,16,17 Pins 7,8 Pins 13, 18	-	667	-	417	-	417	μA
		-	437	-	273	-	273	
		-	456	-	285	-	285	
I <sub>inL</sub>	Input Current Low	0.5	-	0.5	-	0.3	-	μA
V <sub>OH</sub>	High Output Voltage	-1.02	-0.84	-0.98	-0.81	-0.92	-0.735	Vdc
V <sub>OL</sub>	Low Output Voltage	-1.95	-1.63	-1.95	-1.63	-1.95	-1.60	Vdc
V <sub>IH</sub>	High Input Voltage	-1.17	-0.84	-1.13	-0.81	-1.07	-0.735	Vdc
V <sub>IL</sub>	Low Input Voltage	-1.95	-1.48	-1.95	-1.48	-1.95	-1.45	Vdc

1. Each MECL 10H™ series circuit has been designed to meet the dc specifications shown in the test table, after thermal equilibrium has been established. The circuit is in a test socket or mounted on a printed circuit board and transverse air flow greater than 500 lfm is maintained. Outputs are terminated through a 50 Ω resistor to -2.0 V.

**Table 3. AC PARAMETERS**

Symbol	Characteristic	0°		25°		75°		Unit
		Min	Max	Min	Max	Min	Max	
t <sub>pd</sub>	Propagation Delay Data-to-Bus Output Select-to-Bus Output $\overline{OE}$ -to-Bus Output Bus-to-Receiver Select-to-Receiver $\overline{RE}$ -to-Receiver Data-to-Receiver	0.8	3.0	0.8	3.0	0.8	3.2	ns
		0.8	3.4	0.8	3.4	0.8	3.8	
		0.8	2.4	0.8	2.4	0.8	2.6	
		0.8	2.1	0.8	2.1	0.8	2.4	
		1.8	4.5	1.8	4.5	1.8	5.0	
		0.8	2.2	0.8	2.2	0.8	2.5	
		1.3	4.0	1.3	4.0	1.3	4.5	
t <sub>r</sub>	Rise Time	0.5	2.0	0.5	2.0	0.5	2.1	
t <sub>f</sub>	Fall Time	0.5	2.0	0.5	2.0	0.5	2.1	ns

NOTE: Device will meet the specifications after thermal equilibrium has been established when mounted in a test socket or printed circuit board with maintained transverse airflow greater than 500 lfm. Electrical parameters are guaranteed only over the declared operating temperature range. Functional operation of the device exceeding these conditions is not implied. Device specification limit values are applied individually under normal operating conditions and not valid simultaneously.

# MC10H332

Table 4. MULTIPLEXER TRUTH TABLE

OE	S1	S0	X <sub>Bus</sub>	Y <sub>Bus</sub>
H	X	X	-2.0V	-2.0V
L	L	L	X0	Y0
L	L	H	X1	Y1
L	H	L	X2	Y2
L	H	H	X3	Y3

Table 5. RECEIVER TRUTH TABLE

RE	X <sub>in</sub>	Y <sub>in</sub>
H	L	L
L	X <sub>Bus</sub>	Y <sub>Bus</sub>

## LOGIC DIAGRAM

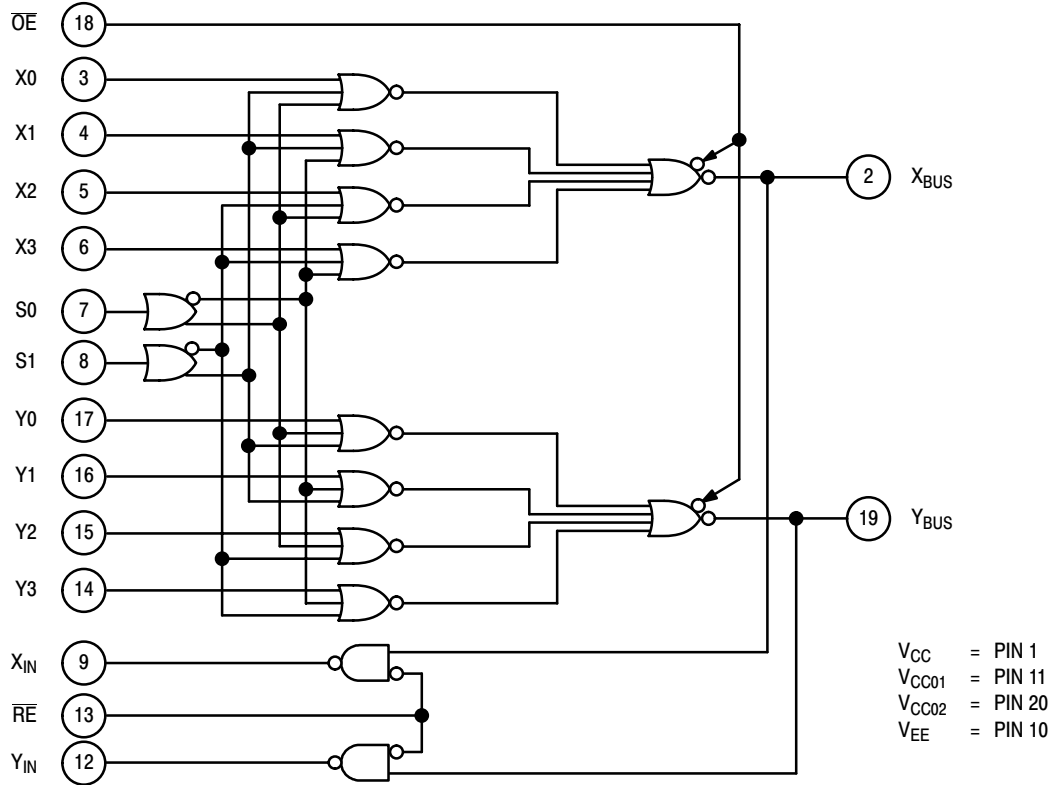

## ORDERING INFORMATION

Device	Package	Shipping <sup>†</sup>
MC10H332FN	PLLC-20	46 Units / Rail
MC10H332FNG	PLLC-20 (Pb-Free)	46 Units / Rail
MC10H332FNR2	PLLC-20	500 / Tape & Reel
MC10H332FNR2G	PLLC-20 (Pb-Free)	500 / Tape & Reel
MC10H332P	PDIP-20	18 Unit / Rail
MC10H332PG	PDIP-20 (Pb-Free)	18 Unit / Rail

<sup>†</sup>For information on tape and reel specifications, including part orientation and tape sizes, please refer to our Tape and Reel Packaging Specifications Brochure, BRD8011/D.

# MC10H332

查询"MC10H332FNG"供应商

## PACKAGE DIMENSIONS

20 LEAD PLLC  
CASE 775-02  
ISSUE E

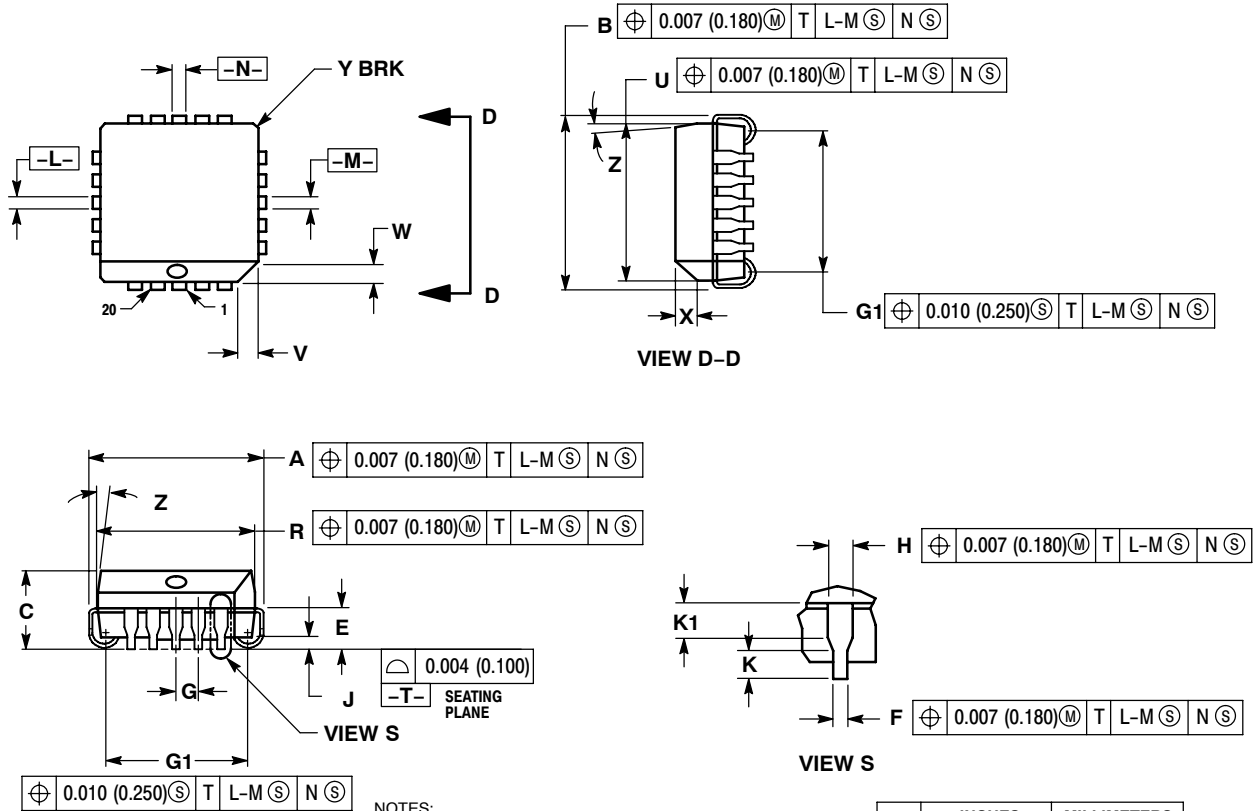

- NOTES:
1. DIMENSIONS AND TOLERANCING PER ANSI Y14.5M, 1982.
  2. DIMENSIONS IN INCHES.
  3. DATUMS -L-, -M-, AND -N- DETERMINED WHERE TOP OF LEAD SHOULDER EXITS PLASTIC BODY AT MOLD PARTING LINE.
  4. DIMENSION G1, TRUE POSITION TO BE MEASURED AT DATUM -T-, SEATING PLANE.
  5. DIMENSIONS R AND U DO NOT INCLUDE MOLD FLASH. ALLOWABLE MOLD FLASH IS 0.010 (0.250) PER SIDE.
  6. DIMENSIONS IN THE PACKAGE TOP MAY BE SMALLER THAN THE PACKAGE BOTTOM BY UP TO 0.012 (0.300). DIMENSIONS R AND U ARE DETERMINED AT THE OUTERMOST EXTREMES OF THE PLASTIC BODY EXCLUSIVE OF MOLD FLASH, TIE BAR BURRS, GATE BURRS AND INTERLEAD FLASH, BUT INCLUDING ANY MISMATCH BETWEEN THE TOP AND BOTTOM OF THE PLASTIC BODY.
  7. DIMENSION H DOES NOT INCLUDE DAMBAR PROTRUSION OR INTRUSION. THE DAMBAR PROTRUSION(S) SHALL NOT CAUSE THE H DIMENSION TO BE GREATER THAN 0.037 (0.940). THE DAMBAR INTRUSION(S) SHALL NOT CAUSE THE H DIMENSION TO BE SMALLER THAN 0.025 (0.635).

DIM	INCHES		MILLIMETERS	
	MIN	MAX	MIN	MAX
A	0.385	0.395	9.78	10.03
B	0.385	0.395	9.78	10.03
C	0.165	0.180	4.20	4.57
E	0.090	0.110	2.29	2.79
F	0.013	0.019	0.33	0.48
G	0.050 BSC		1.27 BSC	
H	0.026	0.032	0.66	0.81
J	0.020	---	0.51	---
K	0.025	---	0.64	---
R	0.350	0.356	8.89	9.04
U	0.350	0.356	8.89	9.04
V	0.042	0.048	1.07	1.21
W	0.042	0.048	1.07	1.21
X	0.042	0.056	1.07	1.42
Y	---	0.020	---	0.50
Z	2°		10°	
G1	0.310	0.330	7.88	8.38
K1	0.040	---	1.02	---

# MC10H332

查询"MC10H332FNG"供应商

## PACKAGE DIMENSIONS

PDIP-20  
P SUFFIX  
PLASTIC DIP PACKAGE  
CASE 738-03  
ISSUE E

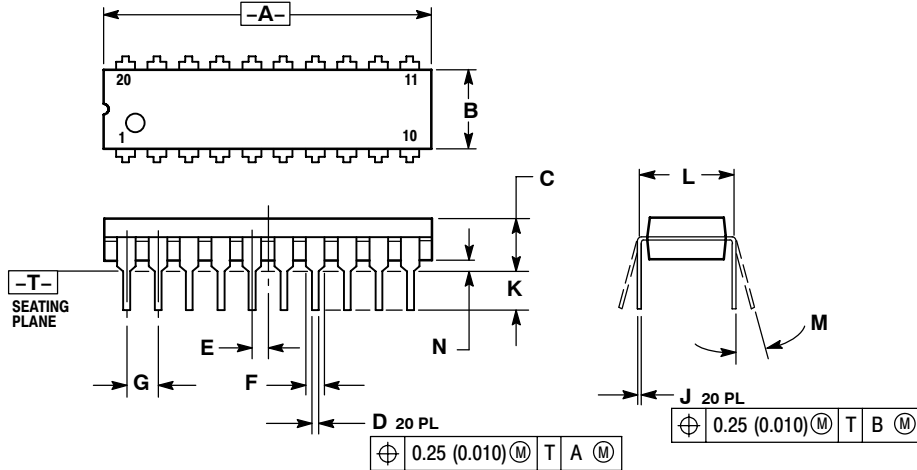

- NOTES:
1. DIMENSIONING AND TOLERANCING PER ANSI Y14.5M, 1982.
  2. CONTROLLING DIMENSION: INCH.
  3. DIMENSION L TO CENTER OF LEAD WHEN FORMED PARALLEL.
  4. DIMENSION B DOES NOT INCLUDE MOLD FLASH.

DIM	INCHES		MILLIMETERS	
	MIN	MAX	MIN	MAX
A	1.010	1.070	25.66	27.17
B	0.240	0.260	6.10	6.60
C	0.150	0.180	3.81	4.57
D	0.015	0.022	0.39	0.55
E	0.050 BSC		1.27 BSC	
F	0.050	0.070	1.27	1.77
G	0.100 BSC		2.54 BSC	
J	0.008	0.015	0.21	0.38
K	0.110	0.140	2.80	3.55
L	0.300 BSC		7.62 BSC	
M	0° 15°		0° 15°	
N	0.020	0.040	0.51	1.01

MECL 10H and MECL 10K are trademarks of Motorola, Inc.

ON Semiconductor and are registered trademarks of Semiconductor Components Industries, LLC (SCILLC). SCILLC reserves the right to make changes without further notice to any products herein. SCILLC makes no warranty, representation or guarantee regarding the suitability of its products for any particular purpose, nor does SCILLC assume any liability arising out of the application or use of any product or circuit, and specifically disclaims any and all liability, including without limitation special, consequential or incidental damages. "Typical" parameters which may be provided in SCILLC data sheets and/or specifications can and do vary in different applications and actual performance may vary over time. All operating parameters, including "Typicals" must be validated for each customer application by customer's technical experts. SCILLC does not convey any license under its patent rights nor the rights of others. SCILLC products are not designed, intended, or authorized for use as components in systems intended for surgical implant into the body, or other applications intended to support or sustain life, or for any other application in which the failure of the SCILLC product could create a situation where personal injury or death may occur. Should Buyer purchase or use SCILLC products for any such unintended or unauthorized application, Buyer shall indemnify and hold SCILLC and its officers, employees, subsidiaries, affiliates, and distributors harmless against all claims, costs, damages, and expenses, and reasonable attorney fees arising out of, directly or indirectly, any claim of personal injury or death associated with such unintended or unauthorized use, even if such claim alleges that SCILLC was negligent regarding the design or manufacture of the part. SCILLC is an Equal Opportunity/Affirmative Action Employer. This literature is subject to all applicable copyright laws and is not for resale in any manner.

### PUBLICATION ORDERING INFORMATION

**LITERATURE FULFILLMENT:**  
Literature Distribution Center for ON Semiconductor  
P.O. Box 61312, Phoenix, Arizona 85082-1312 USA  
**Phone:** 480-829-7710 or 800-344-3860 Toll Free USA/Canada  
**Fax:** 480-829-7709 or 800-344-3867 Toll Free USA/Canada  
**Email:** orderlit@onsemi.com

**N. American Technical Support:** 800-282-9855 Toll Free USA/Canada

**Japan:** ON Semiconductor, Japan Customer Focus Center  
2-9-1 Kamimeguro, Meguro-ku, Tokyo, Japan 153-0051  
**Phone:** 81-3-5773-3850

**ON Semiconductor Website:** <http://onsemi.com>

**Order Literature:** <http://www.onsemi.com/litorder>

For additional information, please contact your local Sales Representative.