

**Description**

The Bay Linear LM2931 are low power voltage regulators designed for a wide range of applications. They are an excellent choice for use in Battery Powered applications. The LM2931 feature low quiescent current (100  $\mu$ A Typ.) and low dropout of only 60mV at light loads and 300mV (typ.) at 100mA. The LM2931 has tight initial tolerance of 0.5% typ., extremely good load and line regulation of 0.05% typ. and very low output temperature coefficient.

The Bay Linear LM2931 is available as a fixed voltage regulator and as an adjustable regulator in TO-92 and 8SOIC packages. The Bay Linear LM2931 in an 8SOIC package has an adjustable output voltage from 3V to 24V, programmed with a pair of external resistor. The logic compatible shutdown enables the regulator to be switched ON and OFF.

**Features**

- **Guaranteed 100mA Output**
- **Fixed Versions 3.3V, 5.0V, 8.0**
- **Very Low Quiescent Current**
- **Low Dropout Voltage**
- **Extremely Tight Load and Line Regulation**
- **Very Low Temperature Coefficient**
- **Current and Thermal Limiting**
- **Reverse Battery Protection of -20V**
- **Transient protection of 60V**
- **Output programmable from 3V to 24V**

**Applications**

- **Battery Powered Systems**
- **Portable instrumentation**
- **Notebooks Computers**
- **Potable Consumer Equipment**
- **Automotive electronics**
- **SMPS Post-Regulator**

**Pin Connection**

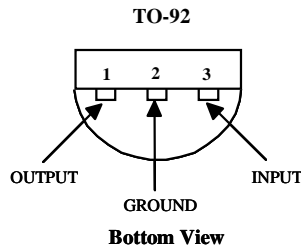
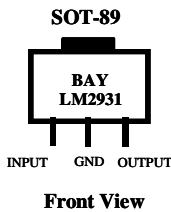

**8SOIC (M)**

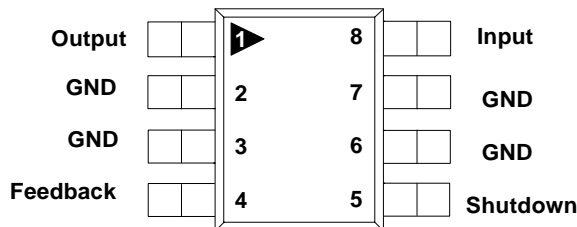

**Ordering Information**

Package	Tolerance
SOT-89	LM2931R-XX
TO-92	LM2931Z-XX
8-SOIC	LM2931M-XX

**“XX” Voltage Selection Guide**

Vout	XX Code
3.3V	33
5.0V	50
8.0V	80
8.5V	85
9.0V	90
10.0V	10
12.0V	12
15.0V	15
Adjustable	Left Blank

**Absolute Maximum Rating**

Parameter	
Power Dissipation	Internally Limited
Lead Temperature ( Soldering 5 seconds )	260 °C
Storage Temperature Range	-65 °C to +150 °C
Operating Junction Temperature	-55 °C to +150 °C
Input Supply Voltage	-20 to +35V

**Electrical Characteristics**

T<sub>J</sub> = 25°C , I<sub>O</sub> = 100µA, V<sub>IN</sub> = 14V ( for 2931-15 V<sub>IN</sub> = 16V), C<sub>O</sub> = 100µF; unless otherwise specified)

Parameter	Conditions	MIN	TYP	MAX	UNIT
Output Voltage (Fixed Version)	-25 °C ≤ T <sub>j</sub> ≤ 85 °C Full Operating Temperature	0.985 [ V <sub>O</sub> ] 0.98 [ V <sub>O</sub> ]	V <sub>O</sub>	1.015 [ V <sub>O</sub> ] 1.02 [ V <sub>O</sub> ]	V
Output Voltage (Fixed Version)	100µA ≤ I <sub>L</sub> ≤ 100mA, T <sub>j</sub> ≤ T <sub>jmax</sub>	0.975 [ V <sub>O</sub> ]	V <sub>O</sub>	1.025 [ V <sub>O</sub> ]	V
Input Supply Voltage				26	V
Output Voltage Temperature Coefficient	(Note 1)		50	150	ppm / ° C
Line Regulation (Note 2)	13V ≤ V <sub>IN</sub> ≤ 26V (Note 3)		0.1	0.4	%
Load Regulation (Note 2)	100µA ≤ I <sub>L</sub> ≤ 100mA		0.1	0.3	%
Dropout Voltage (Note 4)	I <sub>L</sub> = 100µA I <sub>L</sub> = 100mA		60 300	200 600	mV
Ground Current (Note 5)	I <sub>L</sub> = 100µA I <sub>L</sub> = 10mA I <sub>L</sub> = 100mA		100 0.9 8	150 1.5 12	µA mA mA
Dropout Ground Current	V <sub>IN</sub> = (V <sub>OUT</sub> - 0.5V), I <sub>L</sub> = 100µA		110	170	µA
Current Limit	V <sub>OUT</sub> = 0		160	200	mA
Thermal Regulation (Note 6)			0.05	0.2	% / W
Output Noise, 10Hz to 100KHz I <sub>L</sub> = 10mA	C <sub>L</sub> = 2.2µF C <sub>L</sub> = 3.3µF C <sub>L</sub> = 33µF		500 350 120		µVrms
Ripple Rejection Ratio	I <sub>O</sub> = 10mA, f = 120Hz, C <sub>O</sub> = 100µF V <sub>IN</sub> = V <sub>O</sub> + 3V+2Vpp	60			dB
<b>8 pin Versions only (LP2951)</b>					
Reference Voltage	Over Temperature (Note 7)	1.21 1.185	1.235	1.26 1.285	V
Feedback Pin Bias Current			20	40	ηA
Reference Voltage Temperature Coefficient	(Note 1)		50		ppm/°C
Feedback Pin Bias Current Temperature Coefficient			0.1		ηA/°C
<b>Shutdown Input</b>					
Input Logic Voltage	Low (Regulator ON) High (Regulator OFF)	2	1.3	0.7	V
Shutdown Pin Input Current	V <sub>S</sub> = 2.4V V <sub>S</sub> = 26V		30 450	50 600	µA
Regulator Output Current in Shutdown	(Note 8) 5.0V ≤ V <sub>OUT</sub> ≤ 15.0V 3.3V ≤ V <sub>OUT</sub> ≤ 5.0V 2.0V ≤ V <sub>OUT</sub> ≤ 3.3V			10 20 30	µA

**Note 1:** Output or reference voltage temperature coefficients defined as the worst case voltage change divided by the total temperature range.

**Note 2:** Unless otherwise specified all limits guaranteed for  $T_J = 25^\circ\text{C}$ ,  $V_{IN} = V_O + 1\text{V}$ ,  $I_L = 100\mu\text{A}$  and  $C_L = 1\mu\text{F}$ . Additional conditions for the 8-pin versions are feedback tied to -XX Voltage tap and output tied to output Sense pin ( $V_{OUT} = \text{XX V}$ ) and  $V_{SHUTDOWN} \leq 0.8\text{V}$

**Note 2:** Regulation is measured at constant junction temperature, using pulse testing with a low duty cycle. Changes in output voltage due to heating effects are covered under specification for thermal regulation.

**Note 3:** Line regulation for is tested at  $150^\circ\text{C}$  for  $I_L = 1\text{mA}$ . For  $I_L = 100\mu\text{A}$  and  $T_J = 125^\circ\text{C}$ , line regulation is guaranteed by design to 0.2%. for B2931-15  $16\text{V} \leq V_{IN} \leq 26\text{V}$ .

**Note 4:** Dropout voltage is defined as the input to output differential at which the output voltage drops 2% below its nominal value measured at 1V differential.

**Note 5:** Ground pin Current is the regulator quiescent current. The total current drawn from the source is the sum of the ground pin current and output load current.

**Note 6:** Thermal regulation is the change in output voltage at a time T after a change in power dissipation, excluding load or line regulation effects. Specifications are for a 50 mA load pulse (1.25W) for  $T = 10\text{ms}$ .

**Note 7:**  $V_{REF} \leq V_{OUT} \leq (V_{IN} - 1\text{V})$ ,  $2.3\text{V} \leq V_{IN} \leq 26\text{V}$ ,  $100\mu\text{A} \leq I_L \leq 100\text{mA}$ ,  $T_J \leq T_{JMAX}$

**Note 8:**  $V_{SHUTDOWN} \geq 2\text{V}$ ,  $V_{IN} \leq 26\text{V}$ ,  $V_{OUT} = 0$

### Application Hints

The LM2931 requires an output capacitor for device stability. The value required varies greatly depending upon the application circuit and other factors. The high frequency characteristics of electrolytic capacitors depend greatly on the type and also on the manufacturer. Sometimes only bench testing is the only means to determine the proper capacitor type and value. The high quality 100  $\mu\text{F}$  aluminum electrolytic covers all general application circuits, this stability can be obtained with a tantalum electrolytic value of 47  $\mu\text{F}$ .

Another critical point of electrolytic characteristics is its performance over temperature. The LM2931 is designed to operate starting at  $-40^\circ\text{C}$  which may not be true in the case of electrolytic. Higher temperatures generally no problem. The electrolytic type in aluminum will freeze around  $-30^\circ\text{C}$ . This could cause an oscillation at output of regulator. At a lower temperature requirement by many applications the capacitor should maintain its performance. So as a result, for an application which regulator junction temperature does not exceed  $25^\circ\text{C}$ , the output capacitor can be reduced by the

factor of two over the value needed for the entire temperature range.

Other points with linear regulators are that the twitch higher output current stability decreases. In most applications the LM2931 is operating at few milliamps. In these applications the output capacitance can be further reduced. For example, when the regulator is running at 10mA output current the output capacitance value is half compared to the same regulator that is running at 100 mA.

With the LM2931 adjustable regulator, the minimum value of output capacitance is a function of the output voltage. The value decreases with higher output voltages, since the internal loop gain is reduced.

The worst case occurs at the lower temperature and maximum operating currents, the entire circuit and the electrolytic, should be cooled down to the minimum temperature. The minimum of 0.6 volts required at the input of regulator above the output to keep the power dissipation and die heating to its minimum. After the value for the capacitor has been determined for actual use, the value should be doubled.

TYPICAL CHARACTERISTICS

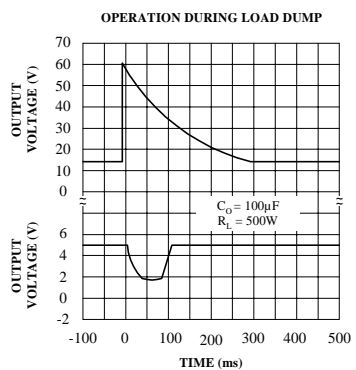
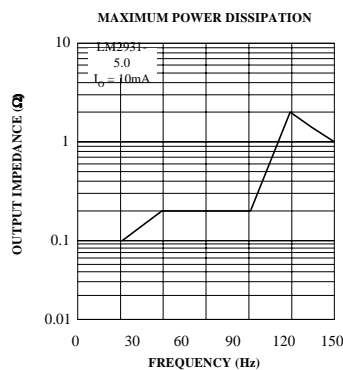
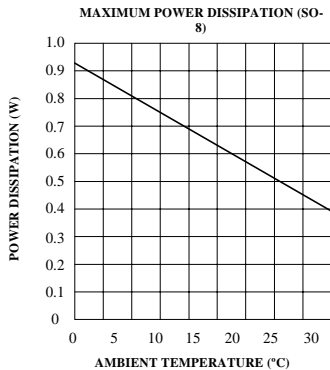
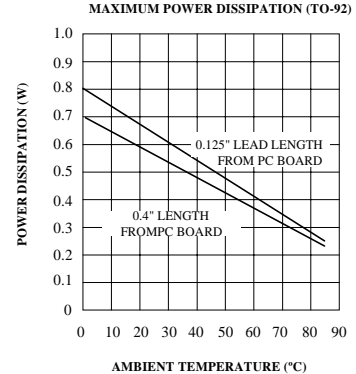
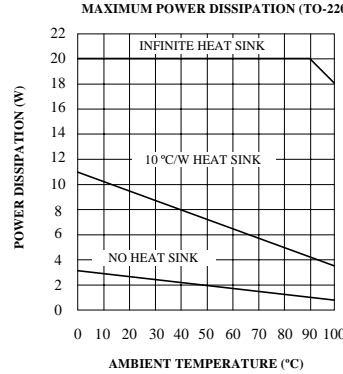
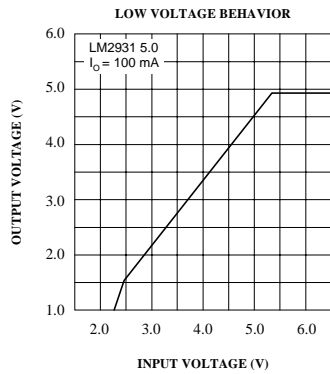
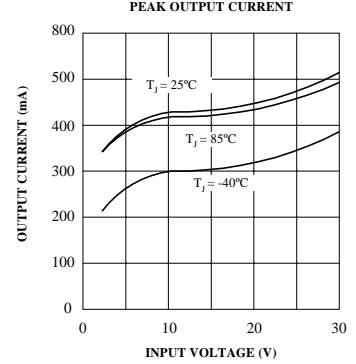
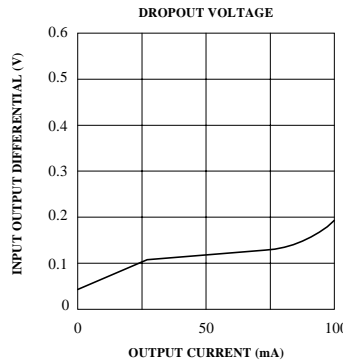
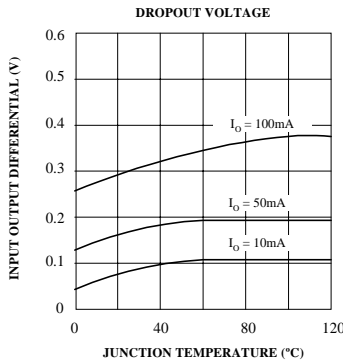
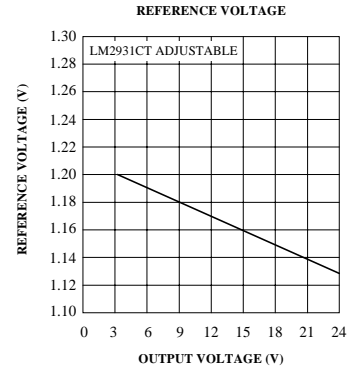
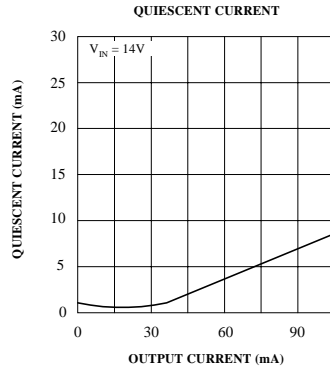
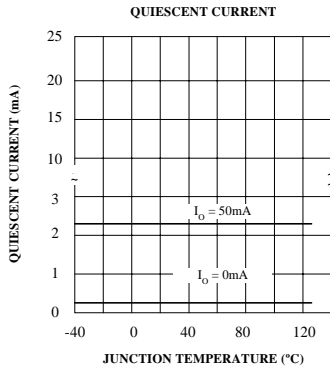

TYPICAL APPLICATIONS

LM2931 ADJUSTABLE OUTPUT

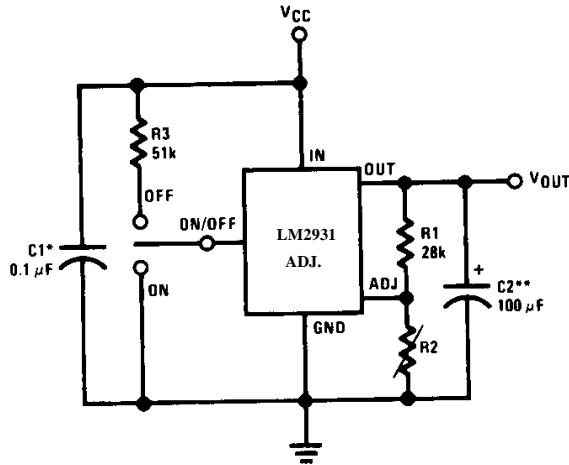

$$V_{OUT} = \text{Reference Voltage} \times \frac{R1 + R2}{R1}$$

LM2931 Fixed Output

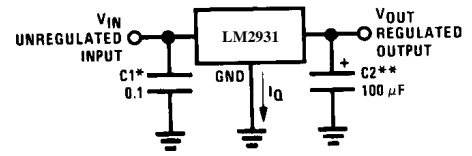

SCHEMATIC DIAGRAM

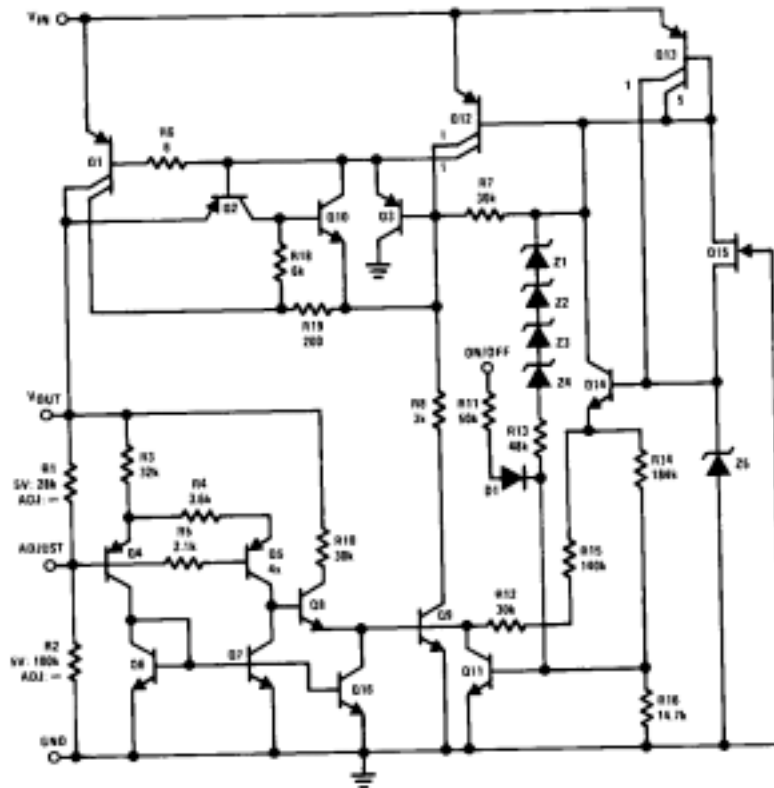

PACKAGE DRAWING

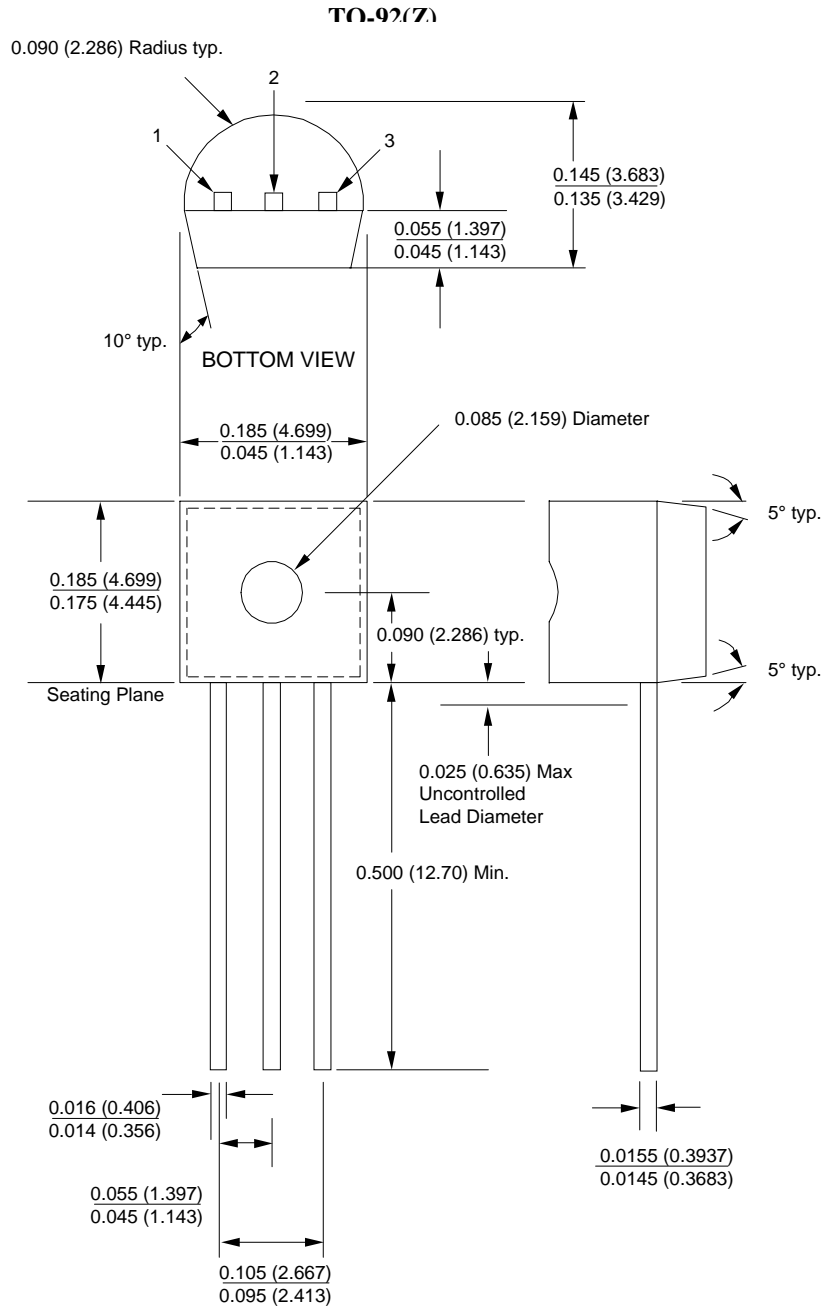

PACKAGE DRAWING

SO-8(M)

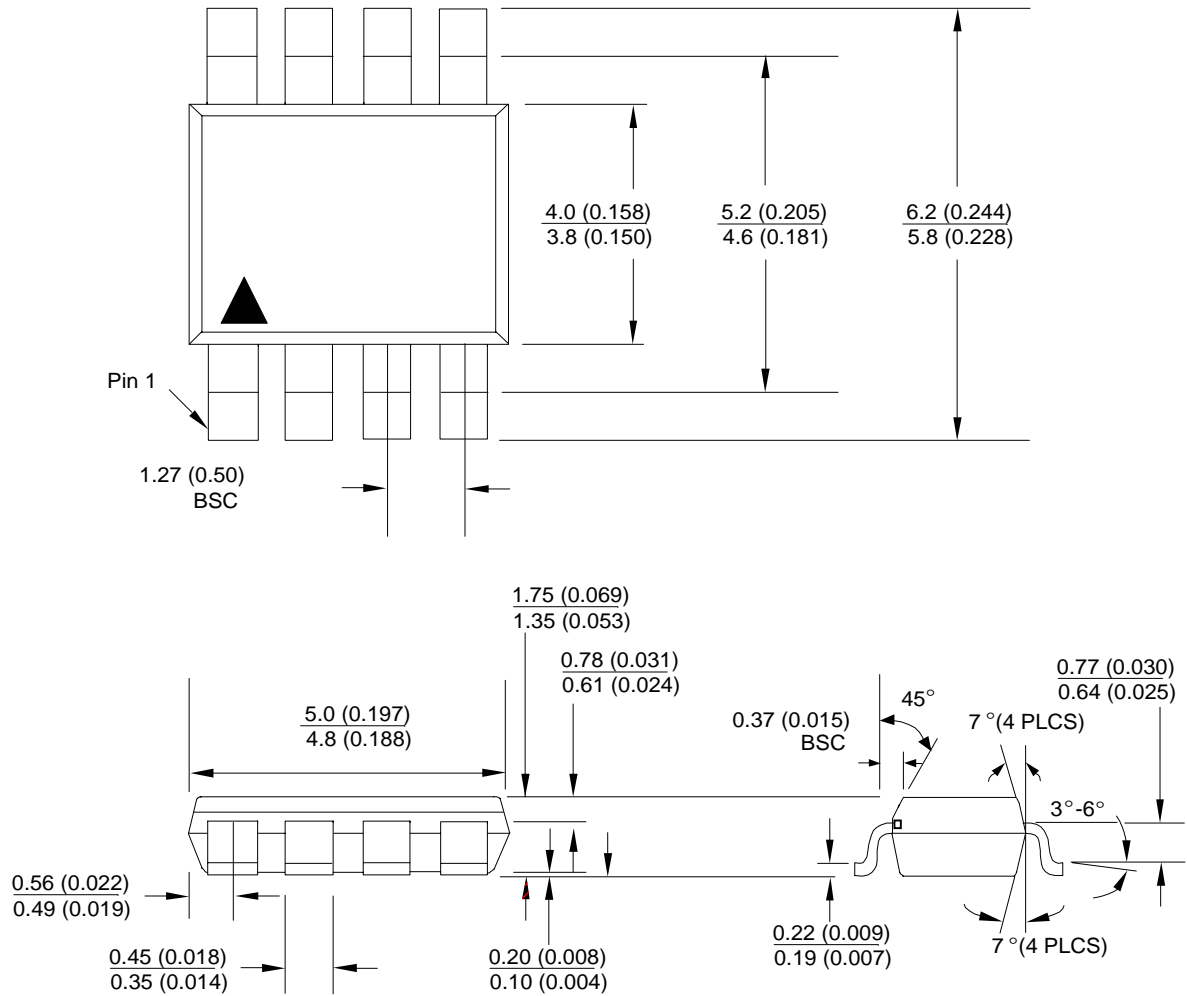

PACKAGE DRAWING

SOT-89®

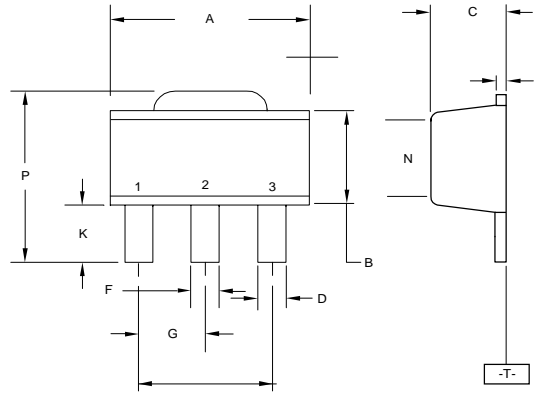

- |  |   |
|--|---|
| <p>STYLE 1</p> <p>PIN 1. BASE</p> <p>2. COLLECTOR</p> <p>3. EMITTER</p>      | <p>STYLE 3</p> <p>PIN 1. GATE</p> <p>2. ANODE</p> <p>3. CATHODE</p> |
| <p>STYLE 2</p> <p>PIN 1. ANODE</p> <p>2. CATHODE</p> <p>3. NO CONNECTION</p> | <p>STYLE 4</p> <p>PIN 1. DRAIN</p> <p>2. GATE</p> <p>3. SOURCE</p>  |

DIM	MILLIMETERS		INCHES	
	MIN	MAX	MIN	MAX
A	4.40	4.60	0.174	0.181
B	2.29	2.60	0.091	0.102
C	1.40	1.60	0.056	0.062
D	0.36	0.48	0.015	0.018
E	1.62	1.80	0.064	0.070
F	0.44	0.53	0.018	0.020
G	150 BSC		0.059 BSC	
J	0.35	0.44	0.014	0.017
K	0.80	1.04	0.032	0.040
L	300 BSC		0.118 BSC	
N	2.04	2.28	0.081	0.089
P	3.94	4.25	0.156	0.167

**Advance Information-** These data sheets contain descriptions of products that are in development. The specifications are based on the engineering calculations, computer simulations and/ or initial prototype evaluation.

**Preliminary Information-** These data sheets contain minimum and maximum specifications that are based on the initial device characterizations. These limits are subject to change upon the completion of the full characterization over the specified temperature and supply voltage ranges.

The application circuit examples are only to explain the representative applications of the devices and are not intended to guarantee any circuit design or permit any industrial property right to other rights to execute. Bay Linear takes no responsibility for any problems related to any industrial property right resulting from the use of the contents shown in the data book. Typical parameters can and do vary in different applications. Customer's technical experts must validate all operating parameters including "Typical" for each customer application.

LIFE SUPPORT AND NUCLEAR POLICY

Bay Linear products are not authorized for and should not be used within life support systems which are intended for surgical implants into the body to support or sustain life, in aircraft, space equipment, submarine, or nuclear facility applications without the specific written consent of Bay Linear President.