

## FEATURES

- I/O Isolation 1500VDC
- MTBF > 1,000,000 Hours
- Industry Standard Pinout
- High Efficiency up to 88%
- CSA1950 Safety Approval
- 2:1 Wide Input Voltage Range
- Complies with EN55022 Class A
- Short Circuit and Over Voltage Protection



## SPECIFICATIONS: LANK 10W Series

All specifications are based on 25°C, Nominal Input Voltage, and Maximum Output Current unless otherwise noted.  
 We reserve the right to change specifications based on technological advances.

SPECIFICATION	TEST CONDITIONS	Min	Nom	Max	Unit
<b>INPUT (V<sub>in</sub>)</b>					
Input Voltage Range	12V input models	9	12	18	VDC
	24V input models	18	24	36	VDC
	48V input models	36	48	75	VDC
Start Voltage	12V input models	7	8	9	VDC
	24V input models	14	16	18	VDC
	48V input models	30	33	36	VDC
Under Voltage Shutdown	12V input models			8.5	VDC
	24V input models			17	VDC
	48V input models			34	VDC
Input Surge Voltage (1000ms)	12V input models	-0.7		25	VDC
	24V input models	-0.7		50	VDC
	48V input models	-0.7		100	VDC
Reverse Polarity Input Current	All models			0.5	A
Reflected Ripple Current			See Table		
Short Circuit Input Power	All models			2500	mW
Input Filter	All models		Pi Filter		
<b>OUTPUT (V<sub>o</sub>)</b>					
Output Voltage Range		See Table			
Output Voltage Accuracy			±0.6	±1.2	%
Output Voltage Balance	Dual Output, Balanced Loads		±0.5	±2.0	%
Load Regulation	I <sub>o</sub> = 10% to 100%		±0.5	±1.2	%
Load Regulation (2.5V output only)	I <sub>o</sub> = 10% to 100%		±0.7	±1.5	%
Line Regulation	V <sub>in</sub> = Min to Max		±0.3	±1.0	%
Output Power				10	W
Output Current Range		See Table			
Ripple & Noise (20MHz)			50	85	mV <sub>pk-pk</sub>
Ripple & Noise (20MHz)	Over Line, Load, and Temperature			100	mV <sub>pk-pk</sub>
Ripple & Noise (20MHz)				15	mV <sub>rms</sub>
Transient Recovery Time	25% Load Step Change		250	500	µs
Transient Response Deviation	25% Load Step Change		±3	±5	%
Temperature Coefficient			±0.01	±0.02	%/°C
<b>PROTECTION</b>					
Over Power Protection		110	150	180	%
Short Circuit Protection		Continuous			
Input Fuse Recommendation	12V input models	2000mA Slow-Blow Type			
	24V input models	1000mA Slow-Blow Type			
	48V input models	500mA Slow-Blow Type			
<b>GENERAL</b>					
Efficiency		See Table			
Switching Frequency			400		KHz
Isolation Voltage Rated	60 seconds	1500			VDC
Isolation Voltage Test	Flash Tested for 1 second	1650			VDC
Isolation Resistance	500VDC	1000			MΩ
Isolation Capacitance	100KHz, 1V		1000	1200	pF
Maximum Capacitive Load		See Table			
Internal Power Dissipation				2500	mW



Wall Industries, Inc. [查询"LANK4825W10"供应商](#)

**LANK 10W Series**  
**2:1 Wide Input Range**  
**Single and Dual Output**  
**10 Watt DC/DC Converter**

SPECIFICATION (CONTINUED)	TEST CONDITIONS	Min	Nom	Max	Unit
<b>ENVIRONMENTAL</b>					
Operating Temperature (Ambient)		-40		+60	°C
Operating Temperature (Case)		-40		+90	°C
Storage Temperature		-40		+125	°C
Lead Temperature	1.5mm from case for 10 seconds			260	°C
Humidity				95	%
Cooling		Free air convection			
MTBF	MIL-HDBK-217F @ 25°C, Ground Benign	1,000,000 Hours			
<b>PHYSICAL</b>					
Weight		17.3 grams			
Dimensions		31.8(L) x 20.3(W) x 10.2(H) mm			
Case Material		Metal with non-conductive baseplate			

**OUTPUT VOLTAGE / CURRENT RATING CHART**

Model Number	Input Voltage	Output Voltage	Output Current		Input Current (Typ)		Reflected Ripple Current (Typ)	Efficiency (Typ)	Max Capacitive Load
			Min	Max	No Load	Max Load			
LANK1233W10	12 VDC (9 – 18 VDC)	3.3 VDC	300mA	3000mA	40mA	1006mA	60mA	82%	2200µF
LANK1205W10		5 VDC	200mA	2000mA		1004mA		83%	2200µF
LANK1251W10		5.1 VDC	200mA	2000mA		1024mA		83%	2200µF
LANK1212W10		12 VDC	83mA	833mA		957mA		87%	820µF
LANK1215W10		15 VDC	66.6mA	666mA		968mA		86%	470µF
LANK1212DW10		±12 VDC	±42mA	±416mA		957mA		87%	220µF
LANK1215DW10		±15 VDC	±33mA	±333mA		968mA		86%	150µF
LANK2425W10		24 VDC (18 – 36 VDC)	2.5 VDC	300mA		3000mA		20mA	377mA
LANK2433W10	3.3 VDC		300mA	3000mA	485mA	85%	2200µF		
LANK2405W10	5 VDC		200mA	2000mA	479mA	87%	2200µF		
LANK2451W10	5.1 VDC		200mA	2000mA	489mA	87%	2200µF		
LANK2412W10	12 VDC		83mA	833mA	479mA	87%	820µF		
LANK2415W10	15 VDC		66.6mA	666mA	478mA	87%	470µF		
LANK2412DW10	±12 VDC		±42mA	±416mA	473mA	87%	220µF		
LANK2415DW10	±15 VDC		±33mA	±333mA	478mA	87%	150µF		
LANK4825W10	48 VDC (36 – 75 VDC)	2.5 VDC	300mA	3000mA	10mA	188mA	40mA	83%	2200µF
LANK4833W10		3.3 VDC	300mA	3000mA		243mA		85%	2200µF
LANK4805W10		5 VDC	200mA	2000mA		239mA		87%	2200µF
LANK4851W10		5.1 VDC	200mA	2000mA		244mA		87%	2200µF
LANK4812W10		12 VDC	83mA	833mA		240mA		87%	820µF
LANK4815W10		15 VDC	66.6mA	666mA		239mA		87%	470µF
LANK4812DW10		±12 VDC	±42mA	±416mA		236mA		87%	220µF
LANK4815DW10		±15 VDC	±33mA	±333mA		243mA		87%	150µF

**NOTES**

- Specifications typical at +25°C, resistive load, nominal input voltage, rated output current unless otherwise noted.
- Transient Recovery Time is measured to within 1% error band for a step change in output of 75% to 100%.
- Ripple and noise measured at 20MHz bandwidth.
- The LANK 10W Series requires a minimum load on the output to maintain specified regulation. Operation under no-load conditions will not damage these devices, however they may not meet all listed specifications.
- All DC/DC converters should be externally fused on the front end for protection.
- Other input and output voltages may be available, please contact factory.
- Specifications subject to change without notice.

### BLOCK DIAGRAMS

Single Output

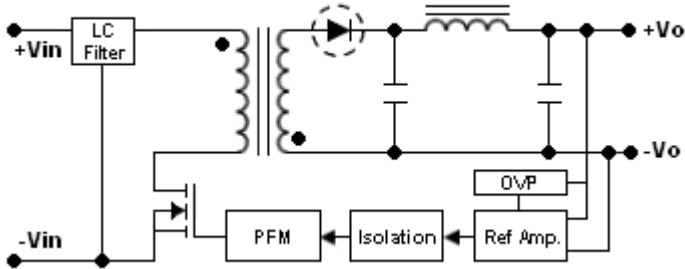

Dual Output

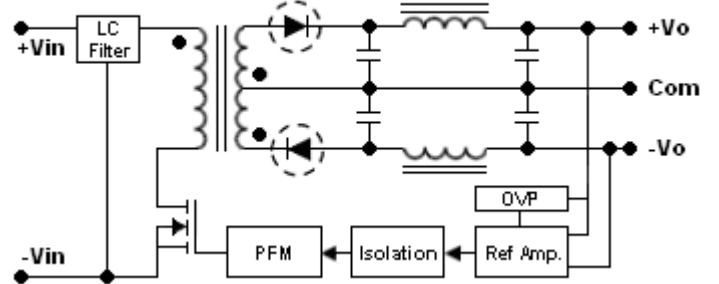

### Input Voltage Transient Rating

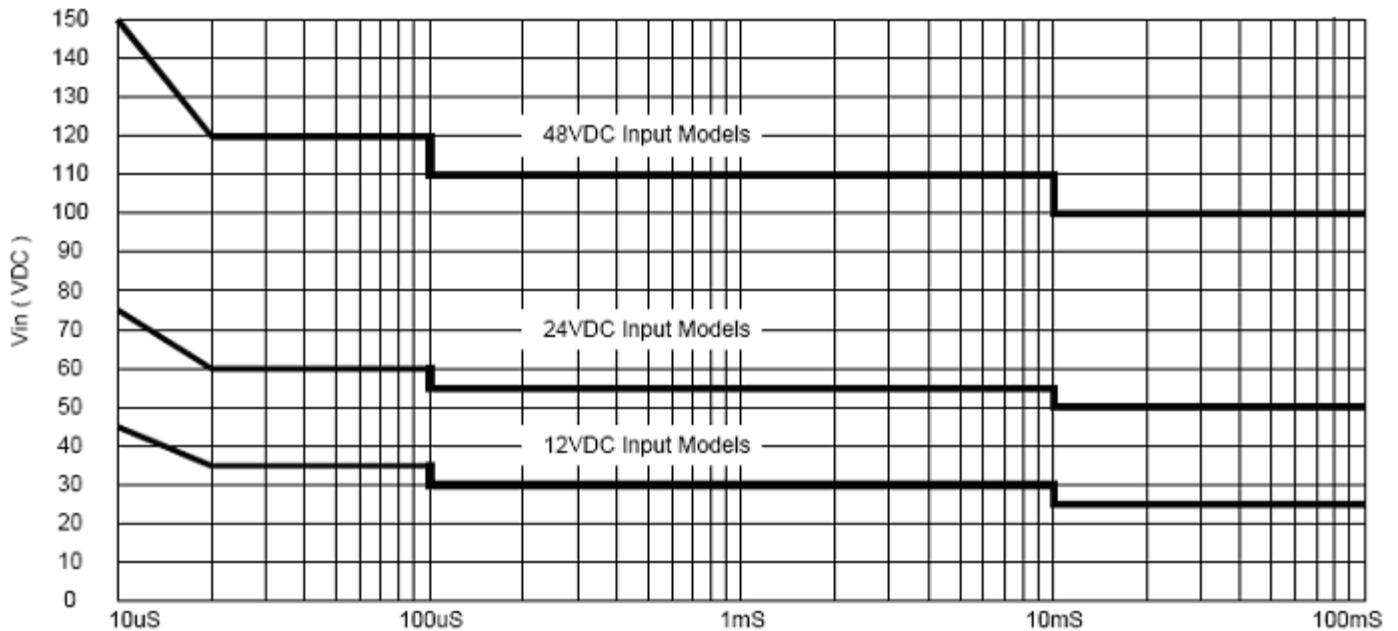

## MECHANICAL DRAWING

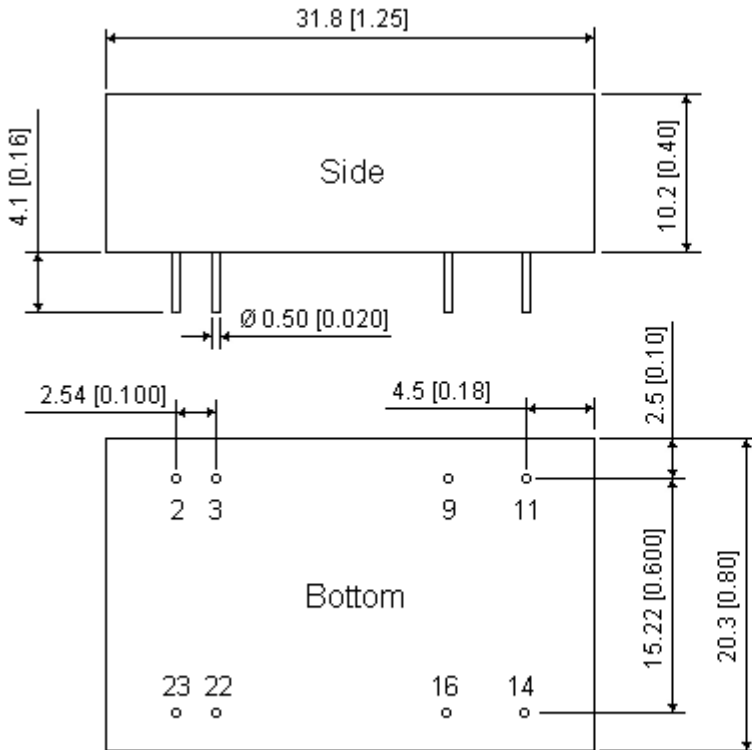

Tolerance:	Millimeters	Inches
	X.X±0.25	X.XX±0.01
	X.XX±0.13	X.XXX±0.005
Pin:	±0.05	±0.002

PIN CONNECTIONS		
Pin	Single Output	Dual Output
2	-Vin	-Vin
3	-Vin	-Vin
9	No Pin	Common
11	NC	-Vout
14	+Vout	+Vout
16	-Vout	Common
22	+Vin	+Vin
23	+Vin	+Vin

## Connecting Pin Patterns

Top View (2.54mm/0.1 inch grids)

### Single Output

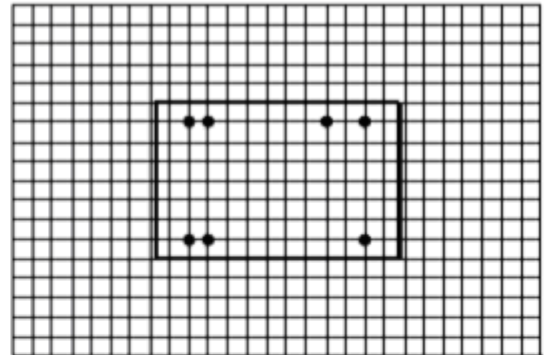

### Dual Output

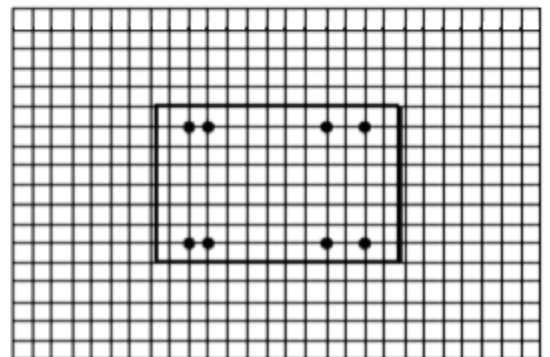

## DESIGN & FEATURE CONSIDERATIONS

### Input Source Impedance

The power module should be connected to a low ac-impedance input source. Highly inductive source impedances can affect the stability of the power module.

In applications where power is supplied over long lines and output loading is high, it may be necessary to use a capacitor at the input to ensure startup.

By using a good quality low Equivalent Series Resistance ( $ESR < 1.0\Omega$  at 100kHz) capacitor of  $12\mu\text{F}$  for the 12V input devices, a  $4.7\mu\text{F}$  for the 24V input devices, and a  $2.2\mu\text{F}$  for the 48V input devices. A capacitor mounted close to the power module helps ensure stability of the unit.

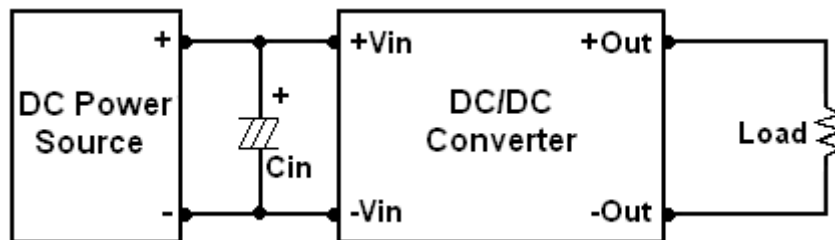

### Maximum Capacitive Load

The LANK 10W Series has a limitation of maximum connected capacitance on the output. The power module may operate in current limiting mode during start-up, affecting the ramp-up and the startup time. The maximum capacitance can be found in the "Output Voltage / Current Rating Chart."

### Over Current Protection

To provide protection in a fault (output overload) condition, the unit is equipped with internal current limiting circuitry and can endure current limiting for an unlimited duration. At the point of current-limit inception, the unit shifts from voltage control to current control. The unit operates normally once the output current is brought back into its specified range.

### Over Voltage Protection

The Output over voltage clamp consists of control circuitry, which is independent of the primary regulation loop that monitors the voltage on the output terminals. The control loop of the clamp has a higher voltage set point than the primary loop. This provides a redundant voltage control that reduces the risk of output over voltage.

### Thermal Considerations

Many conditions affect the thermal performance of the power module, such as orientation, airflow over the module, and board spacing. To avoid exceeding the maximum temperature rating of the components inside the power module, the case temperature must be kept below  $95^{\circ}\text{C}$ . The derating curves are determined from measurements obtained in an experimental apparatus.

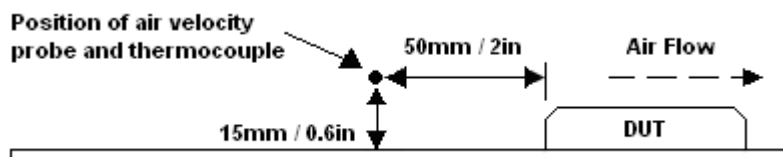

**Efficiency vs Input Voltage ( Single Output )**

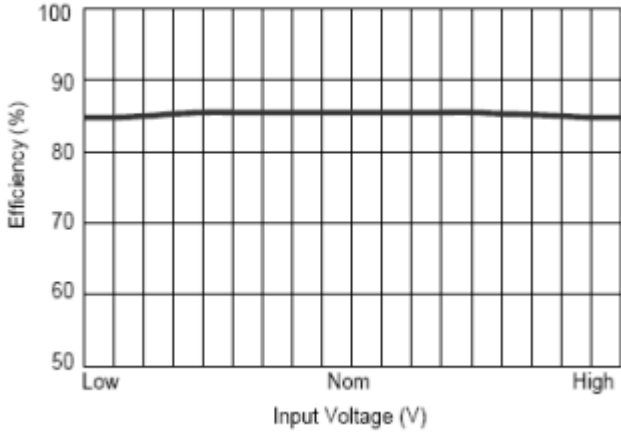

**Efficiency vs Input Voltage ( Dual Output )**

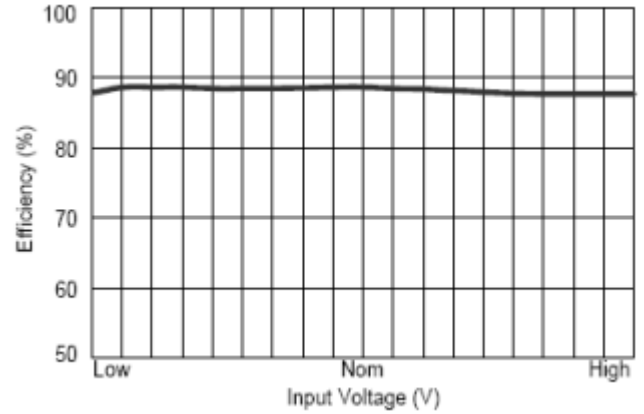

**Efficiency vs Output Load ( Single Output )**

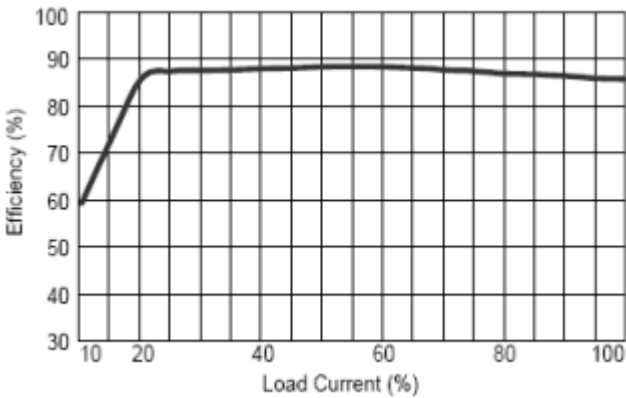

**Efficiency vs Output Load ( Dual Output )**

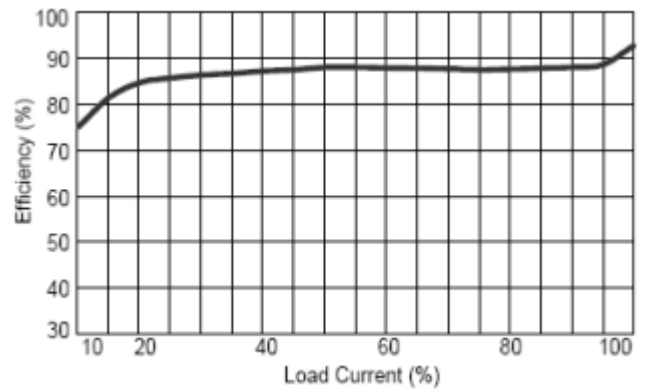

**Derating Curve**

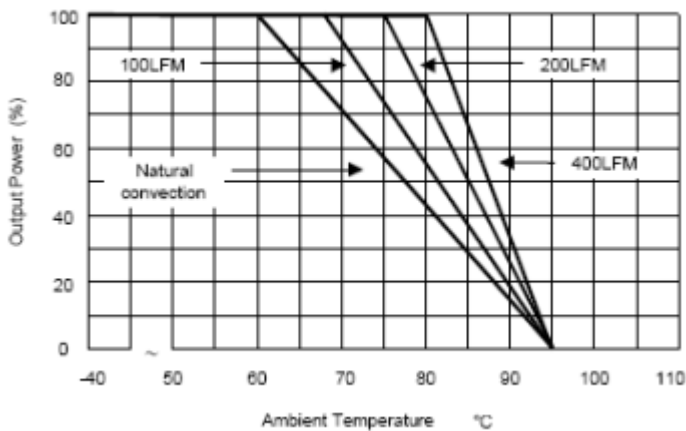

## TEST CONFIGURATIONS

### **Input Reflected-Ripple Current Test Setup**

Input reflected-ripple current is measured with an inductor  $L_{in}$  (4.7 $\mu$ H) and  $C_{in}$  (220 $\mu$ F, ESR < 1.0 $\Omega$  at 100 KHz) to simulate source impedance.

Capacitor  $C_{in}$  offsets possible battery impedance.

Current ripple is measured at the input terminals of the module. Measurement bandwidth is 0-500 KHz.

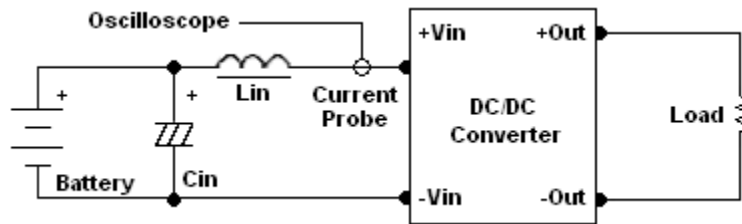

### **Peak-to-Peak Output Noise Measurement Test**

Use a  $C_{out}$  0.47 $\mu$ F ceramic capacitor.

Scope measurement should be made by using a BNC socket, measurement bandwidth is 0-20MHz. Position the load between 50mm and 75mm from the DC/DC Converter.

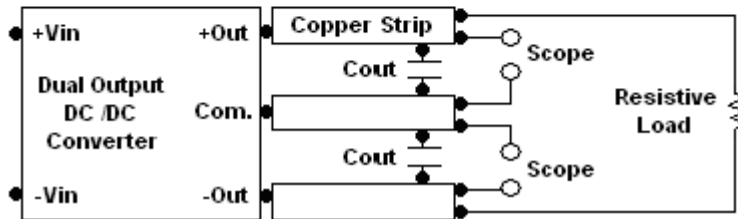
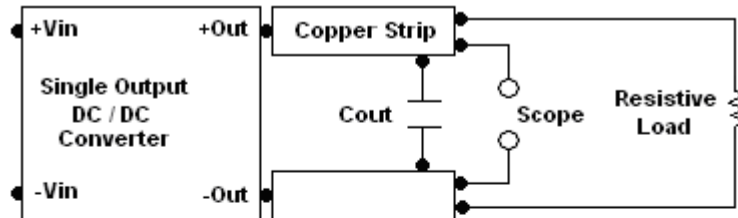

### Output Ripple Reduction

A good quality low ESR capacitor placed as close as possible across the load will give the best ripple and noise performance. To reduce output ripple, it is recommended to use 3.3uF capacitors at the output.

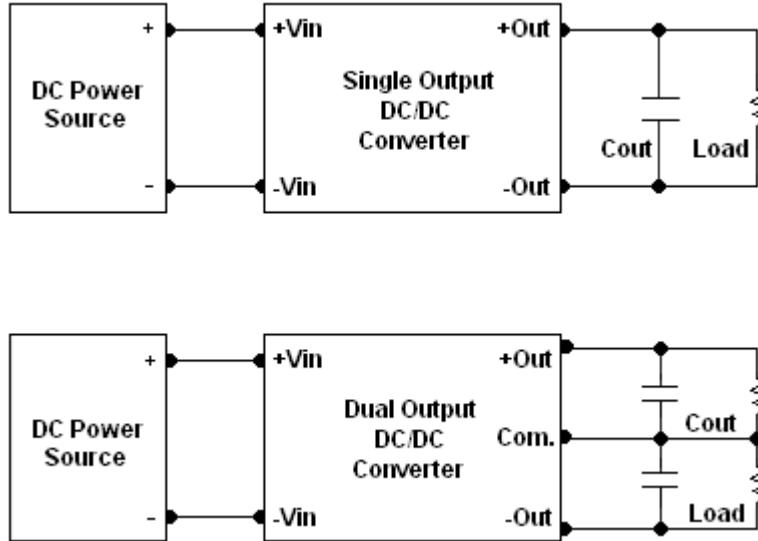

### COMPANY INFORMATION:

Wall Industries, Inc. has created custom and modified units for over 40 years. Our in-house research and development engineers will provide a solution that exceeds your performance requirements on time and on budget. Our ISO9001-2000 certification is just one example of our commitment to producing a high quality, well documented product for our customers.

Our past projects demonstrate our commitment to you, our customer. Wall Industries, Inc. has a reputation for working closely with its customers to ensure each solution meets or exceeds form, fit and function requirements. We will continue to provide ongoing support for your project above and beyond the design and production phases. Give us a call today to discuss your future projects.

Contact **Wall Industries** for further information:

Phone: ☎(603)778-2300  
Toll Free: ☎(888)587-9255  
Fax: ☎(603)778-9797  
E-mail: [sales@wallindustries.com](mailto:sales@wallindustries.com)  
Web: [www.wallindustries.com](http://www.wallindustries.com)  
Address: 5 Watson Brook Rd.  
Exeter, NH 03833