

SCSI-2 Active Terminator Regulator

The MC34268 is a medium current, low dropout positive voltage regulator specifically designed for use in SCSI-2 active termination circuits. This device offers the circuit designer an economical solution for precision voltage regulation, while keeping power losses to a minimum. The regulator consists of a 1.0 V dropout composite PNP/NPN pass transistor, current limiting, and thermal limiting. These devices are packaged in the 8-pin SOP-8 and 3-pin DPAK and SOT-223 surface mount power packages.

Applications include active SCSI-2 terminators and post regulation of switching power supplies.

- 2.85 V Output Voltage for SCSI-2 Active Termination
- 1.0 V Dropout
- Output Current in Excess of 800 mA
- Thermal Protection
- Short Circuit Protection
- Output Trimmed to 1.4% Tolerance
- No Minimum Load Required
- Space Saving DPAK, SOT-223 and SOP-8 Surface Mount Power Packages

Simplified Block Diagram

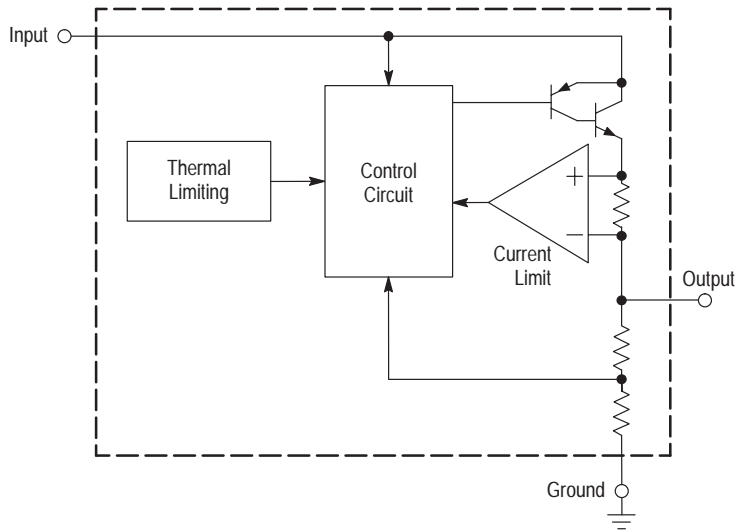

ON Semiconductor

<http://onsemi.com>

MARKING DIAGRAMS



A = Assembly Location
L = Wafer Lot
Y = Year
W = Work Week

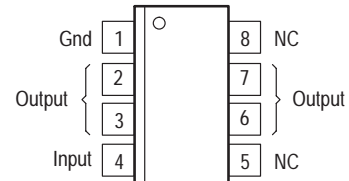

(Top View)

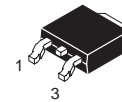

DPAK
DT SUFFIX
CASE 369A



SOT-223
ST SUFFIX
CASE 318E

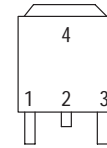
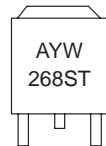

Pin 1. Ground
2. Output
3. Input
4. Output

(Top View)

Heatsink surface (shown as terminal 4 in case outline drawing) is connected to Pin 2.

ORDERING INFORMATION

See detailed ordering and shipping information in the package dimensions section on page 3 of this data sheet.

MAXIMUM RATINGS

查询 MC34268D 供应商

Rating	Symbol	Value	Unit
Power Supply Input Voltage	V_{in}	15	V
Power Dissipation and Thermal Characteristics DT Suffix, Plastic Package, Case 369A $T_A = 25^\circ\text{C}$, Derate Above $T_A = 25^\circ\text{C}$ Thermal Resistance, Junction-to-Case Thermal Resistance, Junction-to-Air D Suffix, Plastic Package, Case 751 $T_A = 25^\circ\text{C}$, Derate Above $T_A = 25^\circ\text{C}$ Thermal Resistance, Junction-to-Case Thermal Resistance, Junction-to-Air ST Suffix, Plastic Package, Case 318E $T_A = 25^\circ\text{C}$, Derate Above $T_A = 25^\circ\text{C}$ Thermal Resistance, Junction-to-Case Thermal Resistance, Junction-to-Air	P_D	Internally Limited	W
	$R_{\theta JC}$	5.0	$^\circ\text{C/W}$
	$R_{\theta JA}$	87	$^\circ\text{C/W}$
	P_D	Internally Limited	W
	$R_{\theta JC}$	22	$^\circ\text{C/W}$
	$R_{\theta JA}$	140	$^\circ\text{C/W}$
	P_D	Internally Limited	W
	$R_{\theta JC}$	15	$^\circ\text{C/W}$
	$R_{\theta JA}$	245	$^\circ\text{C/W}$
Operating Junction Temperature Range	T_J	0 to +150	$^\circ\text{C}$
Storage Temperature	T_{stg}	-55 to +150	$^\circ\text{C}$

ELECTRICAL CHARACTERISTICS

($V_{in} = 4.25\text{ V}$, $C_O = 10\ \mu\text{F}$, for typical values $T_J = 25^\circ\text{C}$, for min/max values $T_J = 0^\circ\text{C}$ to $+125^\circ\text{C}$, unless otherwise noted.)

Characteristic	Symbol	Min	Typ	Max	Unit
Output Voltage ($T_J = 25^\circ\text{C}$, $I_O = 0\text{ mA}$) Output Voltage, over Line, Load, and Temperature ($V_{in} = 3.9\text{ V}$ to 15 V , $I_O = 0\text{ mA}$ to 490 mA)	V_O	2.81 2.76	2.85 2.85	2.89 2.93	V
Line Regulation ($V_{in} = 4.25\text{ V}$ to 15 V , $I_O = 0\text{ mA}$, $T_J = 25^\circ\text{C}$)	Reg _{line}	—	—	0.3	%
Load Regulation ($I_O = 0\text{ mA}$ to 800 mA , $T_J = 25^\circ\text{C}$)	Reg _{load}	—	—	0.5	%
Dropout Voltage ($I_O = 490\text{ mA}$)	$V_{in} - V_O$	—	0.95	1.1	V
Ripple Rejection ($f = 120\text{ Hz}$)	RR	55	—	—	dB
Maximum Output Current ($V_{in} = 5.0\text{ V}$)	$I_{(max)}$	800	—	—	mA
Bias Current ($V_{in} = 4.25\text{ V}$, $I_O = 0\text{ mA}$)	I_B	—	5.0 to 3.0	8.0	mA
Minimum Load Current to maintain Regulation ($V_{in} = 15\text{ V}$)	$I_{L(min)}$	—	—	0	mA

Figure 1. Dropout Voltage versus Output Load Current

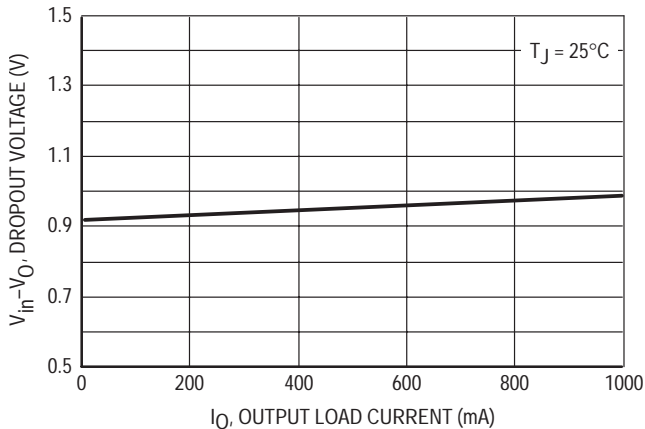
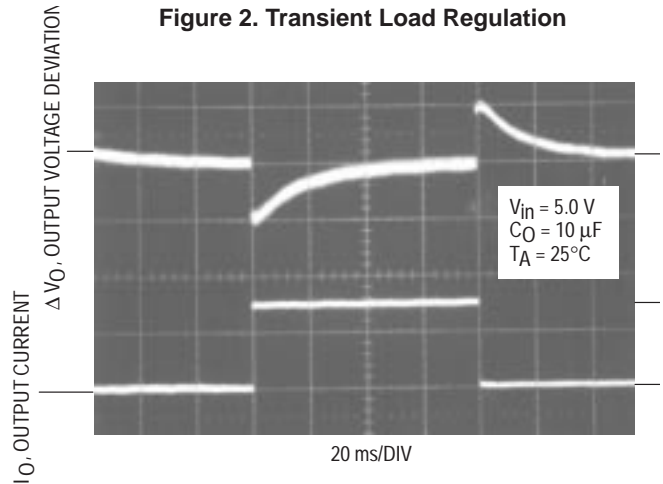

Figure 2. Transient Load Regulation



[查询"MC34268D"供应商](#)

Figure 3. Typical SCSI Application

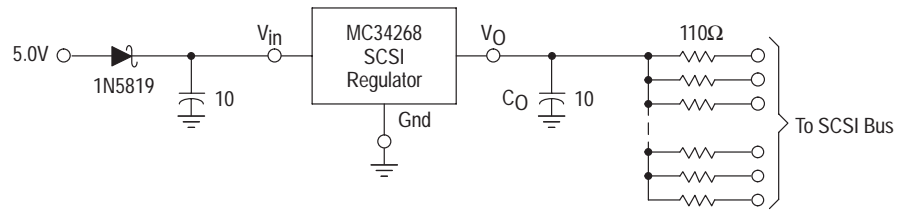

Figure 3 is a circuit of a typical SCSI terminator application. The MC34268 is designed specifically to provide 2.85 V required to drive a SCSI-2 bus. The output current capability of the regulator is in excess of 800 mA; enough to drive standard SCSI-2, fast SCSI-2, and some wide SCSI-2 applications. The typical dropout voltage is less than 1.0 V, allowing the IC to regulate to input voltages less than 4.0 V. Internal protective features include current and thermal limiting.

The MC34268 requires an external 10 µF capacitor with an ESR of less than 10 Ω for stability over temperature. With economical electrolytic capacitors, cold temperature operation can pose a stability problem. As temperature decreases, the capacitance also decreases and the ESR increases, which could cause the circuit to oscillate. Tantalum capacitors may be a better choice if small size is a requirement. Also, the capacitance and ESR of a tantalum capacitor is more stable over temperature.

Figure 4. SOP-8 Thermal Resistance versus P.C.B. Copper Length

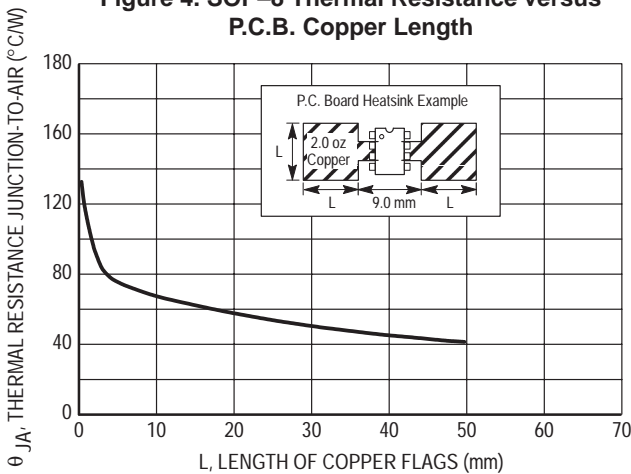
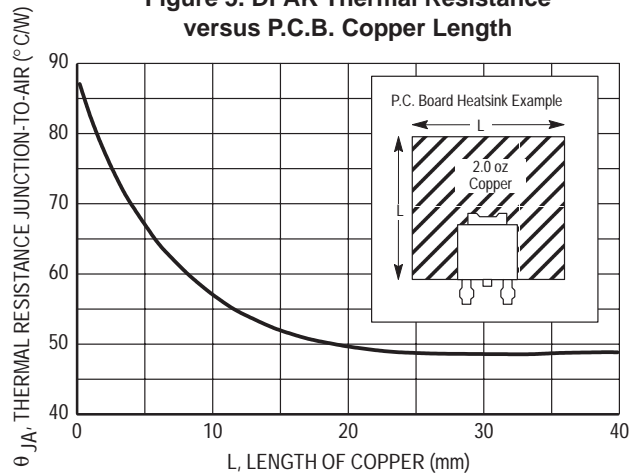

Figure 5. DPAK Thermal Resistance versus P.C.B. Copper Length



ORDERING INFORMATION

Device	Package	Shipping Information
MC34268D	SO-8	98 Units / Rail
MC34268DR2	SO-8	2500 Units / Tape & Reel
MC34268DT	DPAK	75 Units / Rail
MC34268DTRK	DPAK	2500 Units / Tape & Reel
MC34268STT3	SOT-223	4000 Units / Tape & Reel

MC34268

[查询"MC34268D"供应商](#)

PACKAGE DIMENSIONS

SOP-8
D SUFFIX
CASE 751-06
ISSUE T

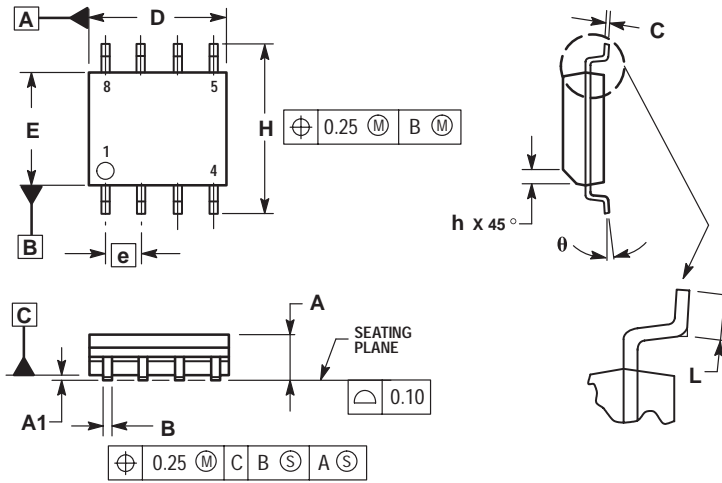

NOTES:

1. DIMENSIONING AND TOLERANCING PER ASME Y14.5M, 1994.
2. DIMENSIONS ARE IN MILLIMETER.
3. DIMENSION D AND E DO NOT INCLUDE MOLD PROTRUSION.
4. MAXIMUM MOLD PROTRUSION 0.15 PER SIDE.
5. DIMENSION B DOES NOT INCLUDE DAMBAR PROTRUSION. ALLOWABLE DAMBAR PROTRUSION SHALL BE 0.127 TOTAL IN EXCESS OF THE B DIMENSION AT MAXIMUM MATERIAL CONDITION.

DIM	MILLIMETERS	
	MIN	MAX
A	1.35	1.75
A1	0.10	0.25
B	0.35	0.49
C	0.19	0.25
D	4.80	5.00
E	3.80	4.00
e	1.27 BSC	
H	5.80	6.20
h	0.25	0.50
L	0.40	1.25
θ	0°	7°

DPAK
DT SUFFIX
CASE 369A-13
ISSUE Z

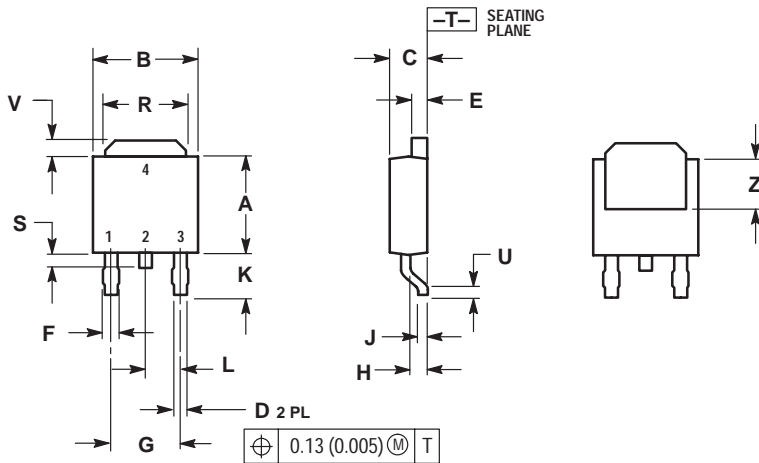

NOTES:

1. DIMENSIONING AND TOLERANCING PER ANSI Y14.5M, 1982.
2. CONTROLLING DIMENSION: INCH.

DIM	INCHES		MILLIMETERS	
	MIN	MAX	MIN	MAX
A	0.235	0.250	5.97	6.35
B	0.250	0.265	6.35	6.73
C	0.086	0.094	2.19	2.38
D	0.027	0.035	0.69	0.88
E	0.033	0.040	0.84	1.01
F	0.037	0.047	0.94	1.19
G	0.180 BSC		4.58 BSC	
H	0.034	0.040	0.87	1.01
J	0.018	0.023	0.46	0.58
K	0.102	0.114	2.60	2.89
L	0.090 BSC		2.29 BSC	
R	0.175	0.215	4.45	5.46
S	0.020	0.050	0.51	1.27
U	0.020	---	0.51	---
V	0.030	0.050	0.77	1.27
Z	0.138	---	3.51	---

MC34268

[查询"MC34268D"供应商](#)

PACKAGE DIMENSIONS

SOT-223
ST SUFFIX
CASE 318E-04
ISSUE K

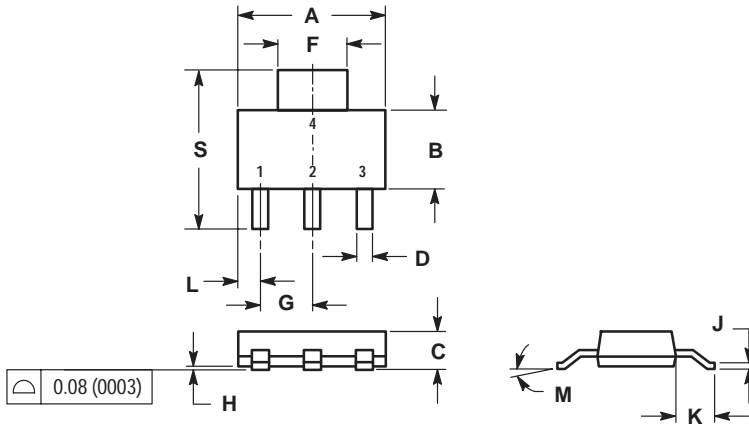

- NOTES:
1. DIMENSIONING AND TOLERANCING PER ANSI Y14.5M, 1982.
2. CONTROLLING DIMENSION: INCH.

DIM	INCHES		MILLIMETERS	
	MIN	MAX	MIN	MAX
A	0.249	0.263	6.30	6.70
B	0.130	0.145	3.30	3.70
C	0.060	0.068	1.50	1.75
D	0.024	0.035	0.60	0.89
F	0.115	0.126	2.90	3.20
G	0.087	0.094	2.20	2.40
H	0.0008	0.0040	0.020	0.100
J	0.009	0.014	0.24	0.35
K	0.060	0.078	1.50	2.00
L	0.033	0.041	0.85	1.05
M	0°	10°	0°	10°
S	0.264	0.287	6.70	7.30

Notes

["MC34268D"供应商](#)

Notes

["MC34268D"供应商](#)

[查询"MC34268D"供应商](#)

ON Semiconductor and  are trademarks of Semiconductor Components Industries, LLC (SCILLC). SCILLC reserves the right to make changes without further notice to any products herein. SCILLC makes no warranty, representation or guarantee regarding the suitability of its products for any particular purpose, nor does SCILLC assume any liability arising out of the application or use of any product or circuit, and specifically disclaims any and all liability, including without limitation special, consequential or incidental damages. "Typical" parameters which may be provided in SCILLC data sheets and/or specifications can and do vary in different applications and actual performance may vary over time. All operating parameters, including "Typicals" must be validated for each customer application by customer's technical experts. SCILLC does not convey any license under its patent rights nor the rights of others. SCILLC products are not designed, intended, or authorized for use as components in systems intended for surgical implant into the body, or other applications intended to support or sustain life, or for any other application in which the failure of the SCILLC product could create a situation where personal injury or death may occur. Should Buyer purchase or use SCILLC products for any such unintended or unauthorized application, Buyer shall indemnify and hold SCILLC and its officers, employees, subsidiaries, affiliates, and distributors harmless against all claims, costs, damages, and expenses, and reasonable attorney fees arising out of, directly or indirectly, any claim of personal injury or death associated with such unintended or unauthorized use, even if such claim alleges that SCILLC was negligent regarding the design or manufacture of the part. SCILLC is an Equal Opportunity/Affirmative Action Employer.

PUBLICATION ORDERING INFORMATION**NORTH AMERICA Literature Fulfillment:**

Literature Distribution Center for ON Semiconductor
P.O. Box 5163, Denver, Colorado 80217 USA
Phone: 303-675-2175 or 800-344-3860 Toll Free USA/Canada
Fax: 303-675-2176 or 800-344-3867 Toll Free USA/Canada
Email: ONlit@hibbertco.com
Fax Response Line: 303-675-2167 or 800-344-3810 Toll Free USA/Canada

N. American Technical Support: 800-282-9855 Toll Free USA/Canada

EUROPE: LDC for ON Semiconductor – European Support

German Phone: (+1) 303-308-7140 (M-F 1:00pm to 5:00pm Munich Time)
Email: ONlit-german@hibbertco.com
French Phone: (+1) 303-308-7141 (M-F 1:00pm to 5:00pm Toulouse Time)
Email: ONlit-french@hibbertco.com
English Phone: (+1) 303-308-7142 (M-F 12:00pm to 5:00pm UK Time)
Email: ONlit@hibbertco.com

EUROPEAN TOLL-FREE ACCESS*: 00-800-4422-3781

*Available from Germany, France, Italy, England, Ireland

CENTRAL/SOUTH AMERICA:

Spanish Phone: 303-308-7143 (Mon-Fri 8:00am to 5:00pm MST)
Email: ONlit-spanish@hibbertco.com

ASIA/PACIFIC: LDC for ON Semiconductor – Asia Support

Phone: 303-675-2121 (Tue-Fri 9:00am to 1:00pm, Hong Kong Time)
Toll Free from Hong Kong & Singapore:
001-800-4422-3781
Email: ONlit-asia@hibbertco.com

JAPAN: ON Semiconductor, Japan Customer Focus Center
4-32-1 Nishi-Gotanda, Shinagawa-ku, Tokyo, Japan 141-8549

Phone: 81-3-5740-2745
Email: r14525@onsemi.com

ON Semiconductor Website: <http://onsemi.com>

For additional information, please contact your local Sales Representative.