

$V_{RSM} = 5000 \text{ V}$
 $I_{F(AV)M} = 3810 \text{ A}$
 $I_{F(RMS)} = 5990 \text{ A}$
 $I_{FSM} = 45 \times 10^3 \text{ A}$
 $V_{F0} = 0.903 \text{ V}$
 $r_F = 0.136 \text{ m}\Omega$

Rectifier Diode

5SDD 38H5000

Doc. No. 5SYA1177-00 Feb. 06

- Optimum power handling capability
- Very low on-state losses

Blocking

Maximum rated values ^{Note 1}

Parameter	Symbol	Conditions	Value	Unit
Repetitive peak reverse voltage	V_{RRM}	$f = 50 \text{ Hz}$, $t_p = 10 \text{ ms}$, $T_j = -40 \dots 160^\circ\text{C}$	5000	V
Non-repetitive peak reverse voltage	V_{RSM}	$f = 50 \text{ Hz}$, $t_p = 10 \text{ ms}$, $T_j = -40 \dots 160^\circ\text{C}$	5000	V

Characteristic values

Parameter	Symbol	Conditions	min	typ	max	Unit
Max. (reverse) leakage current	I_{RRM}	V_{RRM} , $T_j = 160^\circ\text{C}$			110	mA

Derating factor of 0.13% per °C is applicable for T_j below 0 °C.

Mechanical data

Maximum rated values ^{Note 1}

Parameter	Symbol	Conditions	min	typ	max	Unit
Mounting force	F_M		45	50	55	kN
Acceleration	a	Device unclamped			50	m/s^2
Acceleration	a	Device clamped			100	m/s^2

Characteristic values

Parameter	Symbol	Conditions	min	typ	max	Unit
Weight	m			0.9		kg
Housing thickness	H	$F_M = 50 \text{ kN}$, $T_a = 25^\circ\text{C}$	25.5		26.5	mm
Surface creepage distance	D_S		40			mm
Air strike distance	D_a		20			mm

Note 1 Maximum rated values indicate limits beyond which damage to the device may occur

ABB Switzerland Ltd, Semiconductors reserves the right to change specifications without notice.



On-state

Maximum rated values ^{Note 1}

Parameter	Symbol	Conditions	min	typ	max	Unit
Max. average on-state current	$I_{F(AV)M}$	50 Hz, Half sine wave, $T_C = 85^\circ\text{C}$			3810	A
Max. RMS on-state current	$I_{F(RMS)}$				5990	A
Max. peak non-repetitive surge current	I_{FSM}	$t_p = 10\text{ ms}$, $T_j = 160^\circ\text{C}$, $V_R = 0\text{ V}$			45×10^3	A
Limiting load integral	I^2t				9.6×10^6	A^2s
Max. peak non-repetitive surge current	I_{FSM}	$t_p = 8.3\text{ ms}$, $T_j = 160^\circ\text{C}$, $V_R = 0\text{ V}$			48×10^3	A
Limiting load integral	I^2t				10.1×10^6	A^2s

Characteristic values

Parameter	Symbol	Conditions	min	typ	max	Unit
On-state voltage	V_F	$I_F = 4000\text{ A}$, $T_j = 160^\circ\text{C}$			1.43	V
Threshold voltage	$V_{(T0)}$	$T_j = 160^\circ\text{C}$			0.903	V
Slope resistance	r_T	$I_T = 6000 \dots 18000\text{ A}$			0.136	$\text{m}\Omega$

Switching

Characteristic values

Parameter	Symbol	Conditions	min	typ	max	Unit
Recovery charge	Q_{rr}	$di_F/dt = -30\text{ A}/\mu\text{s}$, $V_R = 100\text{ V}$ $I_{FRM} = 2000\text{ A}$, $T_j = 160^\circ\text{C}$		9000		μAs

Thermal

Maximum rated values ^{Note 1}

Parameter	Symbol	Conditions	min	typ	max	Unit
Operating junction temperature range	T_{vj}		-40		160	°C
Storage temperature range	T_{stg}		-40		160	°C

Characteristic values

Parameter	Symbol	Conditions	min	typ	max	Unit
Thermal resistance junction to case	$R_{th(j-c)}$	Double-side cooled $F_m = 45...55$ kN			8	K/kW
	$R_{th(j-c)A}$	Anode-side cooled $F_m = 45...55$ kN			14.5	K/kW
	$R_{th(j-c)C}$	Cathode-side cooled $F_m = 45...55$ kN			18.0	K/kW
Thermal resistance case to heatsink	$R_{th(c-h)}$	Double-side cooled $F_m = 45...55$ kN			2.5	K/kW
	$R_{th(c-h)}$	Single-side cooled $F_m = 45...55$ kN			5.0	K/kW

Analytical function for transient thermal impedance:

$$Z_{th(j-c)}(t) = \sum_{i=1}^n R_{th i} (1 - e^{-t/t_i})$$

i	1	2	3	4
$R_{th i}$ (K/kW)	4.533	2.255	0.868	0.345
τ_i (s)	0.4406	0.1045	0.0092	0.0022

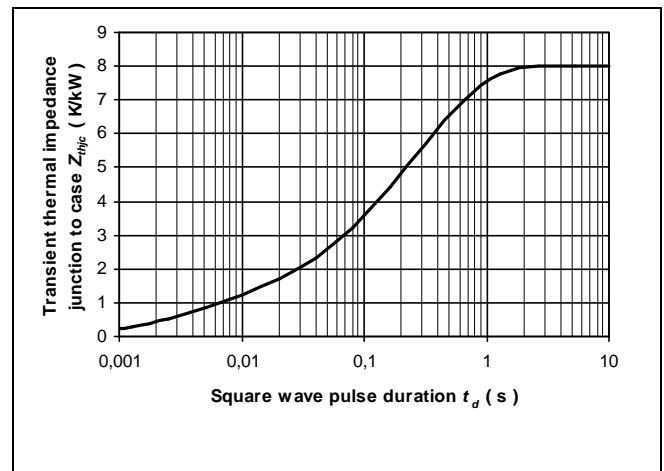

Fig. 1 Transient thermal impedance junction-to-case

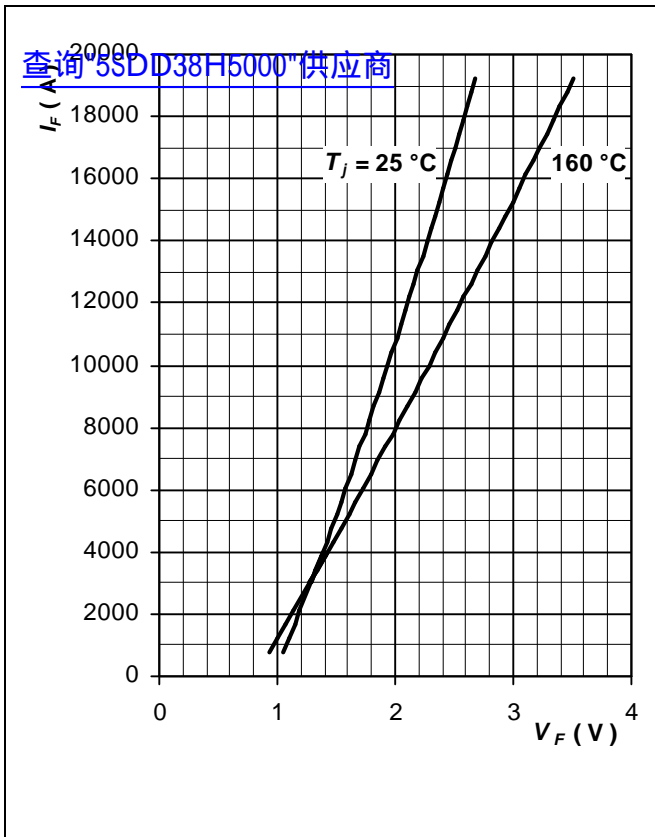

Fig. 2 Max. on-state characteristics

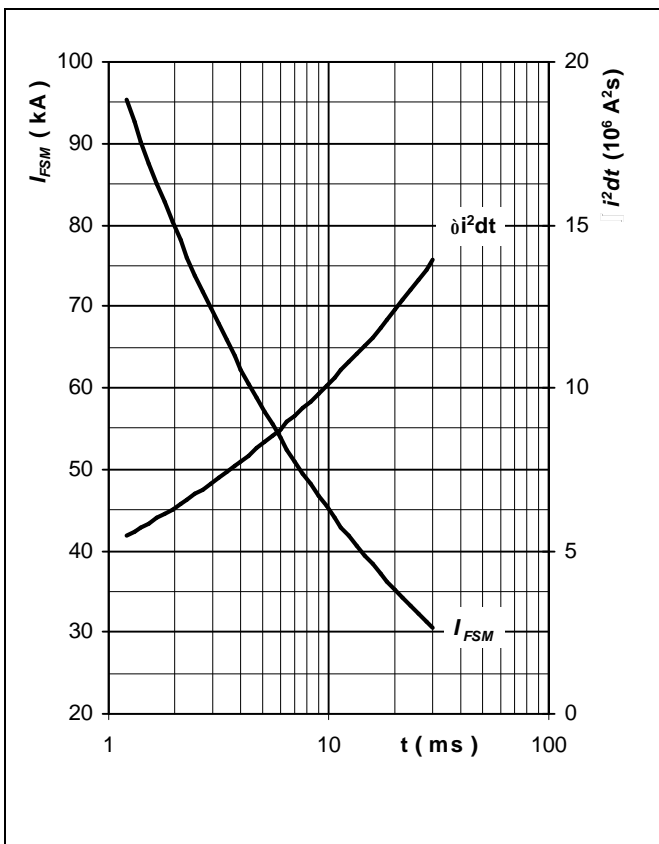

Fig. 3 Surge forward current vs. pulse length, half sine wave, single pulse, $V_R = 0 \text{ V}$

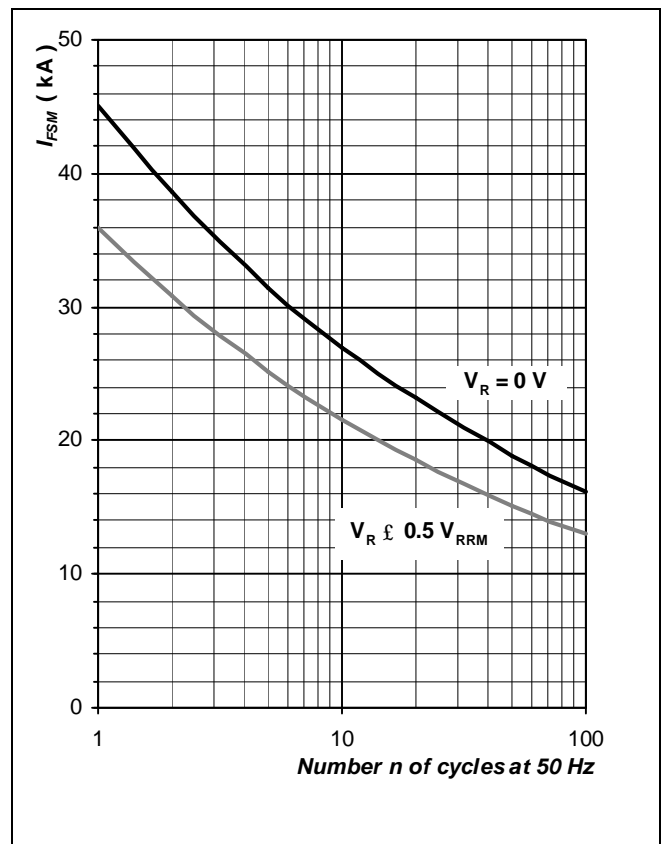

Fig. 4 Surge forward current vs. number of pulses, half sine wave, $V_R = 0 \text{ V}$

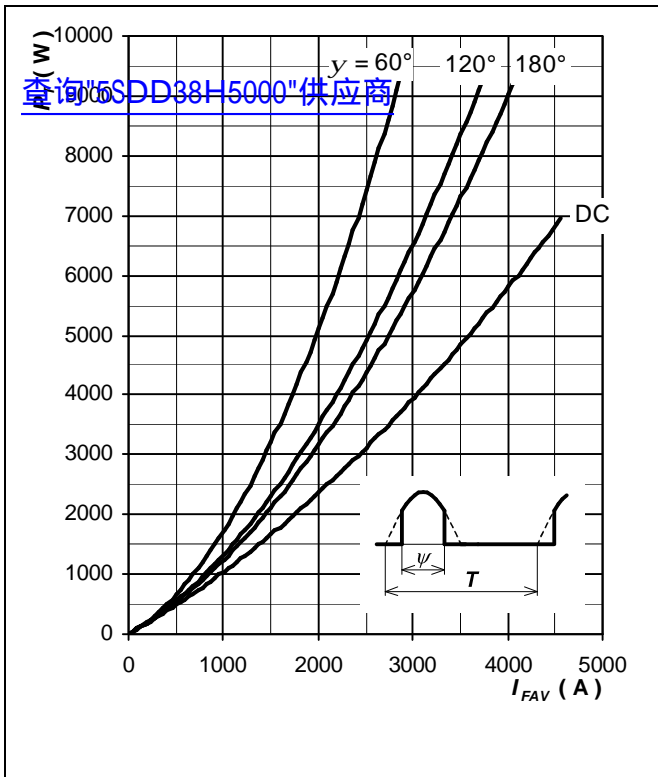

Fig. 5 Forward power loss vs. average forward current, sine waveform, $f = 50$ Hz

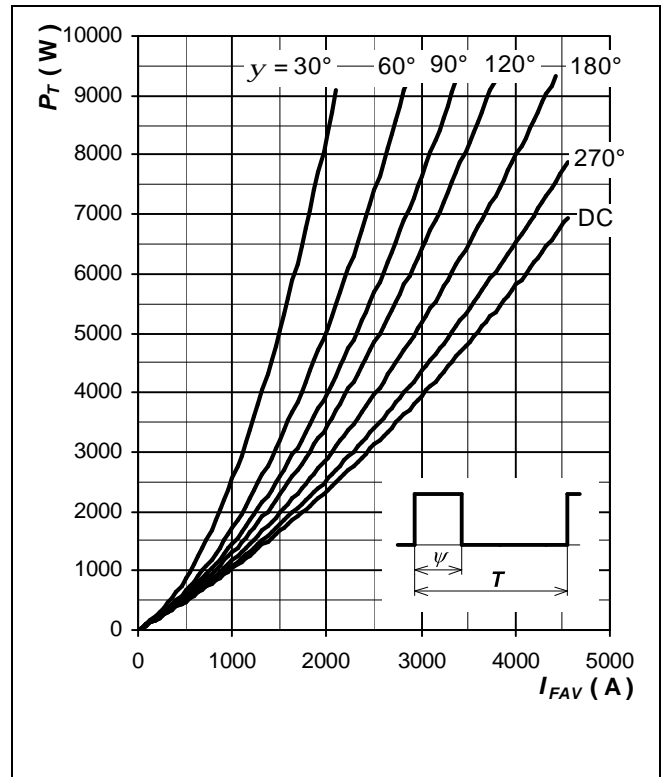

Fig. 6 Forward power loss vs. average forward current, square waveform, $f = 50$ Hz

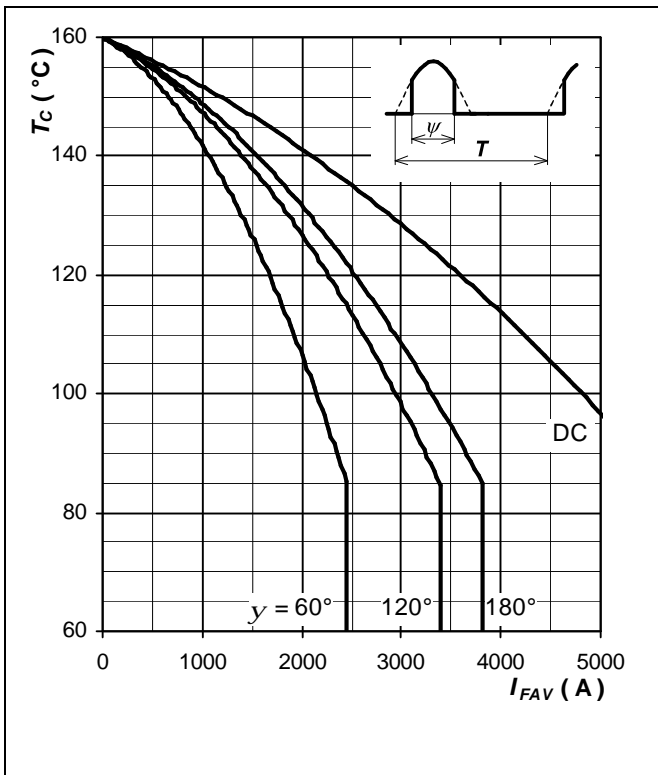

Fig. 7 Max. case temperature vs. aver. forward current, sine waveform, $f = 50$ Hz

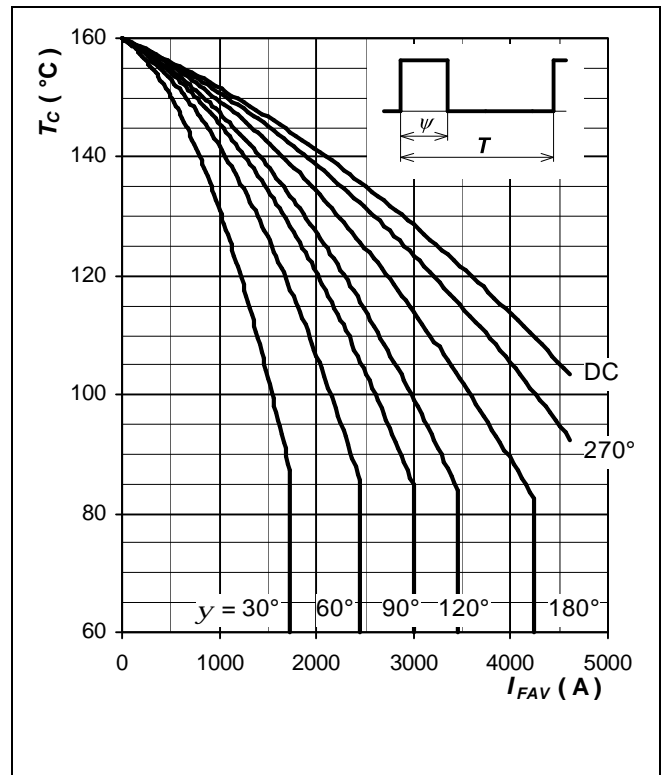

Fig. 8 Max. case temperature vs. aver. forward current, square waveform, $f = 50$ Hz

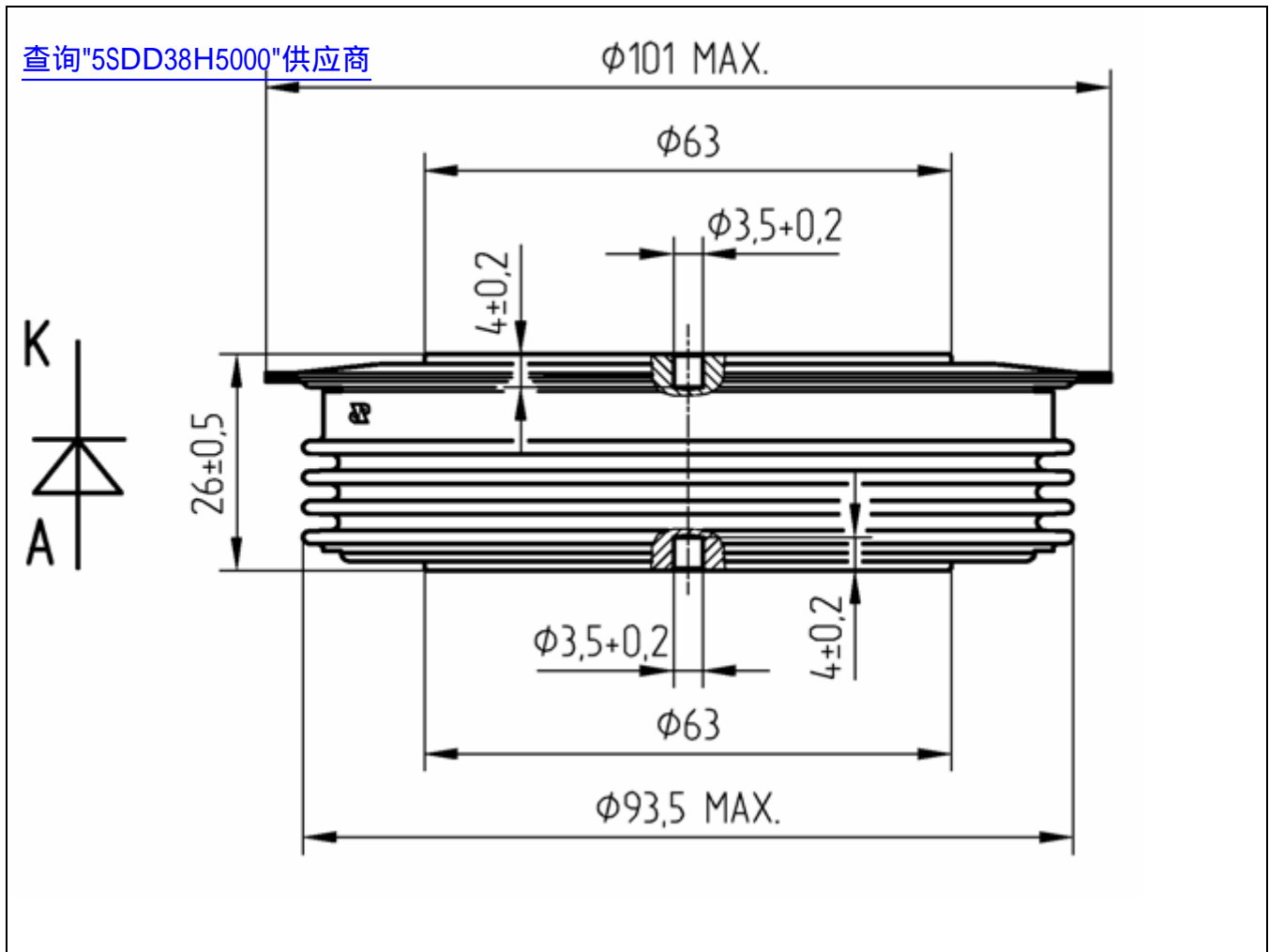

Fig. 9 Outline drawing; all dimensions are in millimeters and represent nominal values unless stated otherwise

Related documents:

- 5SYA 2020 Design of RC-Snubbers for Phase Control Applications
- 5SYA 2029 Designing Large Rectifiers with High Power Diodes
- 5SYA 2036 Recommendations regarding mechanical clamping of Press Pack High Power Semiconductors

Please refer to <http://www.abb.com/semiconductors> for actual versions.

ABB Switzerland Ltd, Semiconductors reserves the right to change specifications without notice.

ABB

ABB Switzerland Ltd
Semiconductors
 Fabrikstrasse 3
 CH-5600 Lenzburg, Switzerland

Doc. No. 5SYA1177-00 Feb. 06

Telephone +41 (0)58 586 1419
 Fax +41 (0)58 586 1306
 Email abbsem@ch.abb.com
 Internet www.abb.com/semiconductors