



T-31-17

PNP SILICON HIGH FREQUENCY TRANSISTOR

NE88900
NE88912
NE88933
NE88935

FEATURES

- PNP COMPLEMENT TO NE327
- HIGH GAIN BANDWIDTH PRODUCT: $f_r = 4$ GHz
- HIGH GAIN: 18 dB at 500 MHz
- LOW NOISE: 2 dB at 500 MHz
- RELIABLE: Gold Metallization and Rugged Packages

DESCRIPTION AND APPLICATIONS

The NE889 series of PNP silicon transistors is designed for ultra high speed current mode switching applications and microwave amplifiers up to 2 GHz. The NE889 is available in several package styles and in chip form (NE88900). The NE88935 is an economical metal ceramic stripline version which features low parasitic elements and is ideal for low cost hybrid circuits. Reliability is assured by NEC's stringent production controls, which are patterned after MIL-S-19500 and Pt/Si-Ti-Pt-Au metallization.

PERFORMANCE SPECIFICATIONS (TA = 25°C)

PART NUMBER EIAJ ¹ REGISTERED NUMBER PACKAGE OUTLINE			NE88900 00 (CHIP)			NE88912 2SA1228 12 (TO-72)			NE88933 2SA1424 33 (MINI-MOLD)			NE88935 2SA1223 35 (MICRO-X)		
SYMBOLS	PARAMETERS AND CONDITIONS	UNITS	MIN	TYP	MAX	MIN	TYP	MAX	MIN	TYP	MAX	MIN	TYP	MAX
f_r	Gain Bandwidth Product at VCE = -5 V, Ic = -15 mA	GHz		4			4		3	4		3	4	
$ S_{21E} ^2$	Insertion Power Gain at VCE = -10 V, Ic = -15 mA, f = 0.5 GHz f = 1 GHz f = 2 GHz	dB dB dB					13 7.2 2		6	8		8	16 10 4.2	
NFMIN	Minimum Noise Figure ² at VCE = -10 V, Ic = -3 mA, f = 0.2 GHz f = 0.5 GHz f = 1 GHz	dB dB dB		2.5			2 2.5 3			3	4		1.8 2 2.5	3.5 4
MAG	Maximum Available Gain ³ at VCE = -10 V, Ic = -15 mA, f = 0.5 GHz f = 1 GHz f = 2 GHz	dB dB dB		12			14.5 9 3			9.3			18 12 7	

Notes:

1. Electronic Industrial Association of Japan.
2. Output and Input are tuned for minimum noise figure.
3. Maximum Available Gain (MAG) is calculated from the device S-Parameters using the following equation,

$$MAG = |S_{21E}|^2 \cdot \frac{1}{1 - |S_{11E}|^2} \cdot \frac{1}{1 - |S_{22E}|^2}$$

NE88900, NE88912, NE88933, NE88935

[查询"2SA1223"供应商](#)

ELECTRICAL CHARACTERISTICS (TA = 25°C)

PART NUMBER EIAJ ¹ REGISTERED NUMBER PACKAGE OUTLINE			NE88900 00 (CHIP)			NE88912 2SA1228 12 (TO-72)			NE88933 2SA1424 33 (MINI-MOLD)			NE88935 2SA1223 35 (MICRO-X)		
SYMBOLS	PARAMETERS AND CONDITIONS	UNITS	MIN	TYP	MAX	MIN	TYP	MAX	MIN	TYP	MAX	MIN	TYP	MAX
Icbo	Collector Cutoff Current at V _{CB} = -10 V, I _E = 0	μA			-0.1			-0.1			-0.1			-0.1
Iebo	Emitter Cutoff Current at V _{EB} = -2 V, I _C = 0	μA			-0.1			-0.1			-0.1			-0.1
hFE	Forward Current Gain at V _{CE} = -10 V, I _C = -15 mA		20	90	200	20	90	200	20	90	200	20	90	200
C _{CB}	Collector to Base Capacitance ² at V _{CB} = -5 V, I _E = 0 mA, f = 1 MHz	pF		1.2	1.5		1.2	1.5		1.1	3		1	1.5
R _{TH}	Thermal Resistance (Junction-to-Case)	°C/W			31			500			700			620
P _T	Total Power Dissipation	mW						300			200			250

Notes:

1. Electronic Industrial Association of Japan.
2. Capacitance is measured with emitter and case connected to the guard terminal at the bridge.

ABSOLUTE MAXIMUM RATINGS (TA = 25°C)

SYMBOLS	PARAMETERS	UNITS	RATINGS
V _{CB0}	Collector to Base Voltage	V	-20
V _{CE0}	Collector to Emitter Voltage	V	-12
V _{EB0}	Emitter to Base Voltage	V	-3
I _C	Collector Current	mA	-50
T _J	Junction Temperature	°C	200
T _{STG}	Storage Temperature	°C	-65 to +200*

*The NE88935 Grade D (Industrial) version has a T_{STG} of -65 to +150°C.

TYPICAL DEVICE CHARACTERISTICS (TA = 25°C)

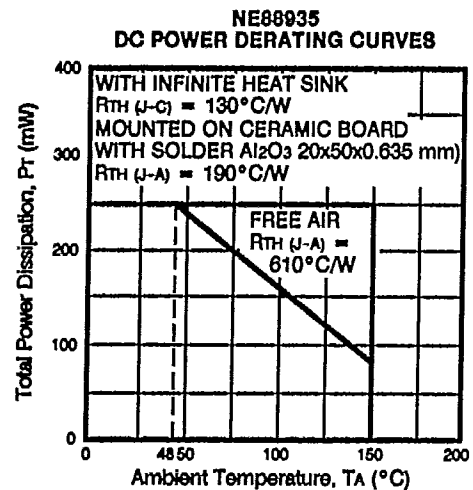
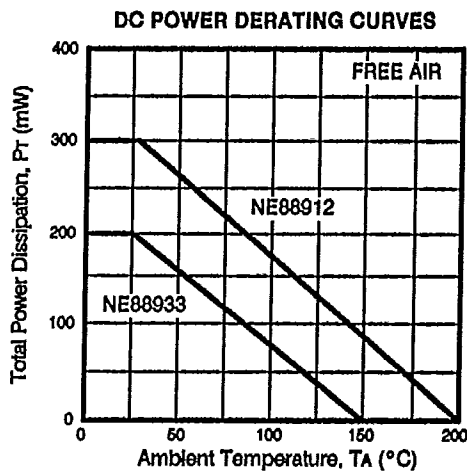

查询"2SA1223"供应商

OUTLINE DIMENSIONS (Units in mm)

NE88900 (CHIP)
 Chip Thickness: 160 μm TYP

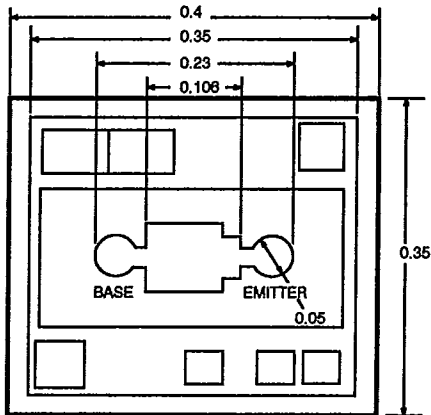

OUTLINE 33
 (SOT-23)

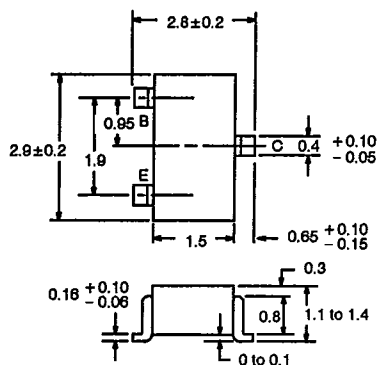

OUTLINE 12
 (TO-72)

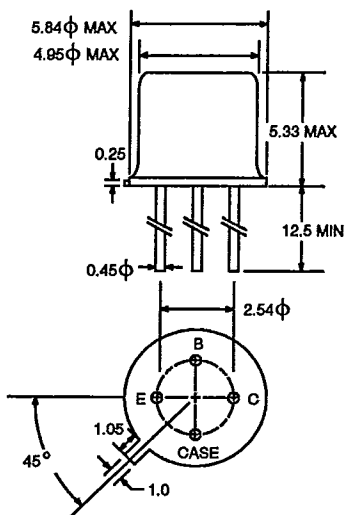

OUTLINE 35
 (MICRO-X)

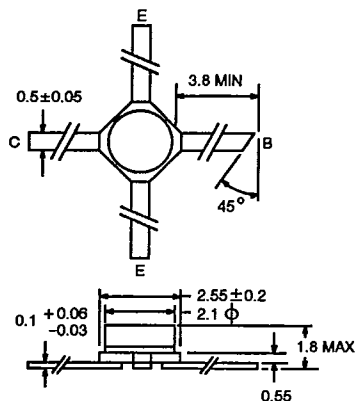

TYPICAL PERFORMANCE CHARACTERISTICS (T_A = 25°C)

GAIN BANDWIDTH vs. COLLECTOR CURRENT

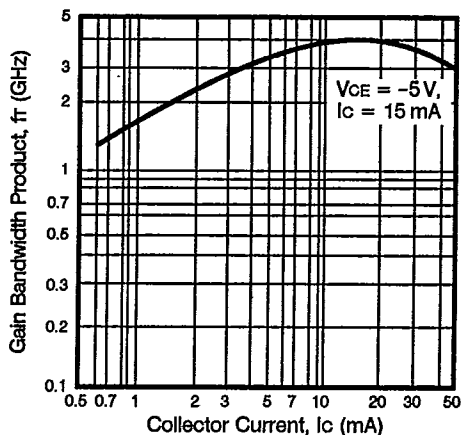

DEVICE CAPACITANCE

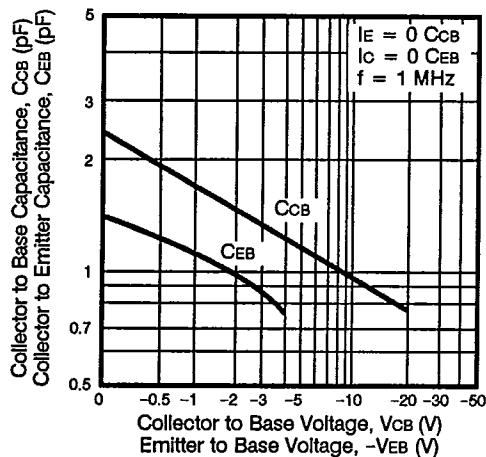

查询"2SA1223"供应商

TYPICAL PERFORMANCE CHARACTERISTICS (T_A = 25°C)

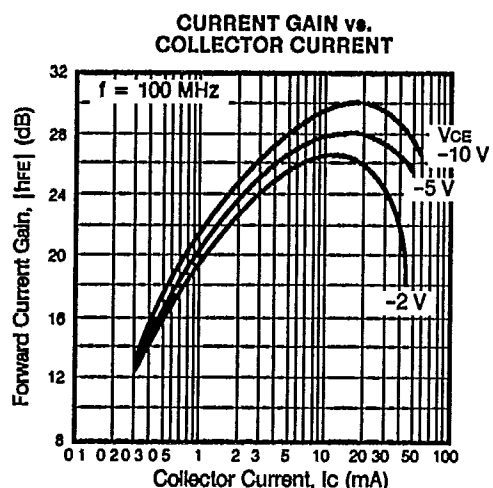
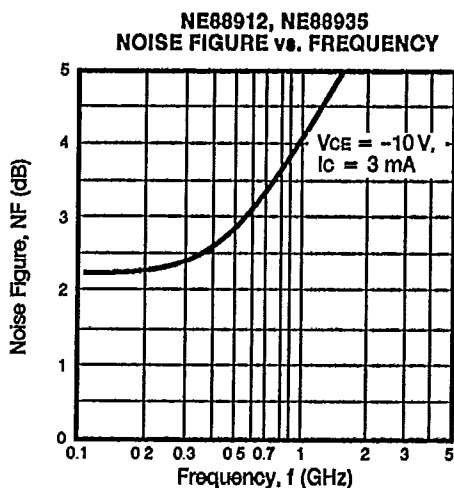
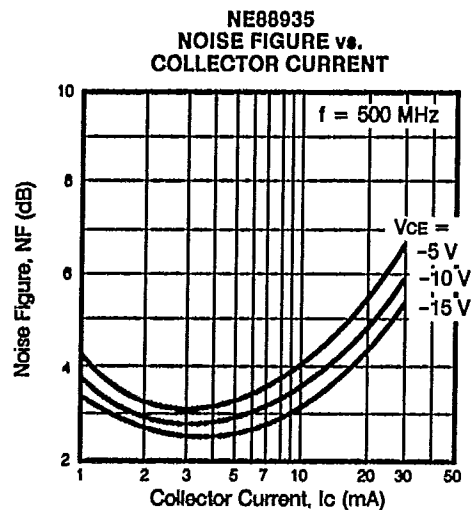
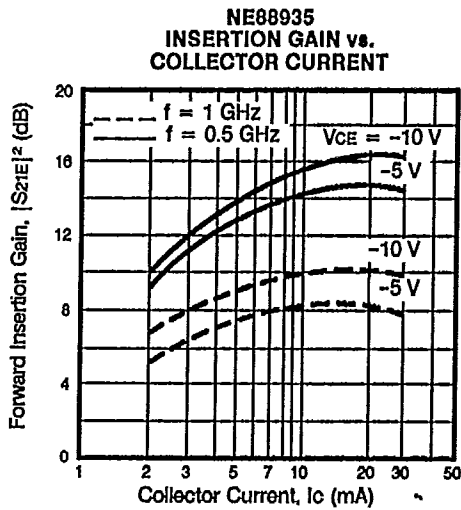
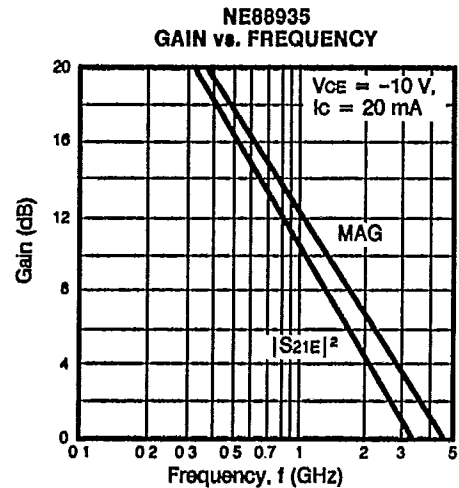
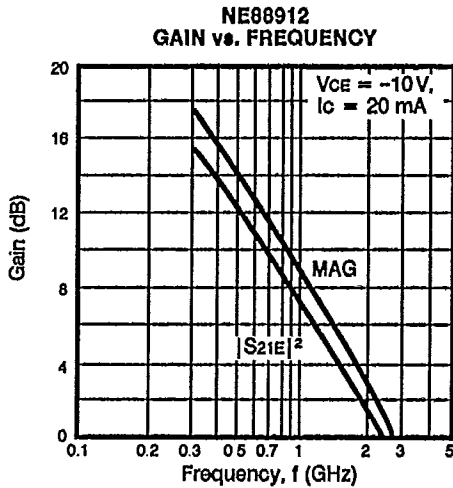

查询"2SA1223"供应商

TYPICAL COMMON EMITTER SCATTERING PARAMETERS

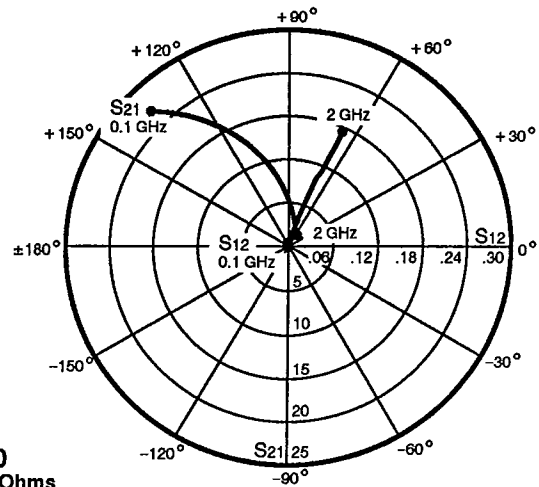
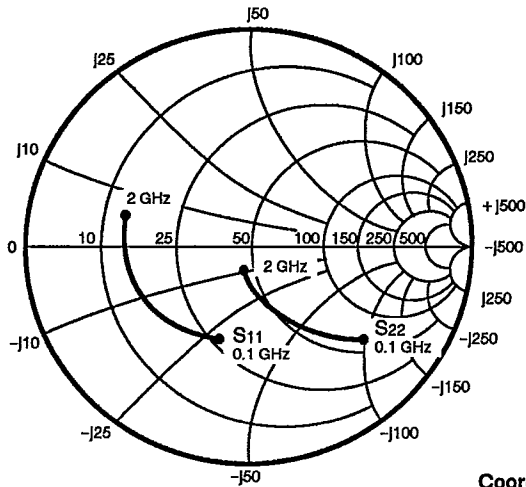

NE88900
Coordinates in Ohms
Frequency in GHz
(VCE = -10 V, IC = -30 mA)

S-MAGN AND ANGLES:

VCE = -10 V, IC = -5 mA

FREQUENCY (MHz)

S11

S21

S12

S22

100	.75	-39	11.69	154	.021	78	.90	-21
500	.55	-128	5.34	103	.097	44	.40	-64
1000	.49	-155	2.89	84	.128	47	.27	-74
1500	.49	-173	2.03	72	.160	48	.20	-80
2000	.53	176	1.60	63	.195	51	.19	-89

VCE = -10 V, IC = -10 mA

100	.60	-60	17.27	146	.016	71	.82	-30
500	.53	-149	6.10	98	.066	50	.28	-78
1000	.50	-168	3.21	82	.107	57	.19	-91
1500	.51	178	2.24	71	.146	58	.14	-99
2000	.55	170	1.74	63	.186	59	.13	-108

VCE = -10 V, IC = -20 mA

100	.48	-88	21.54	138	.007	70	.72	-38
500	.54	-162	6.39	94	.045	58	.21	-87
1000	.51	-175	3.31	80	.093	64	.15	-99
1500	.53	173	2.29	70	.139	63	.10	-105
2000	.57	166	1.77	62	.182	65	.11	-115

VCE = -10 V, IC = -30 mA

100	.44	-105	22.51	135	.004	78	.68	-39
500	.55	-166	6.25	92	.044	61	.18	-84
1000	.53	-178	3.22	79	.090	68	.14	-92
1500	.54	172	2.22	69	.134	66	.09	-94
2000	.59	165	1.71	61	.177	66	.11	-106

NE88900, NE88912, NE88933, NE88935

查询"2SA1223"供应商

TYPICAL COMMON EMITTER SCATTERING PARAMETERS

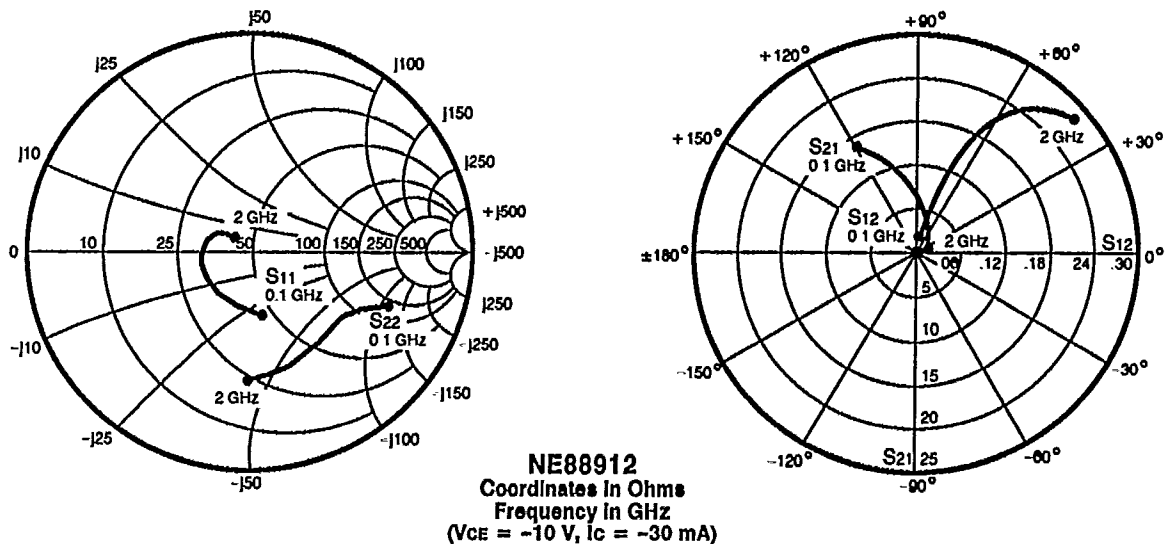

S-MAGN AND ANGLES:

VCE = -10 V, IC = -5 mA

FREQUENCY (MHz)

	S11		S21		S12		S22	
100	.65	-40	10.20	141	.035	70	.85	-20
500	.30	-114	3.95	88	.112	59	.55	-41
1000	.20	-154	2.23	62	.178	56	.49	-54
1500	.16	-173	1.62	41	.237	49	.51	-72
2000	.12	-164	1.30	21	.281	37	.57	-89

VCE = -10 V, IC = -10 mA

100	.49	-51	13.51	132	.031	73	.78	-23
500	.22	-128	4.25	83	.106	64	.49	-38
1000	.17	-166	2.34	60	.182	59	.46	-51
1500	.14	179	1.70	40	.244	50	.49	-69
2000	.09	-167	1.36	21	.290	38	.54	-87

VCE = -10 V, IC = -20 mA

100	.36	-65	14.73	123	.027	72	.70	-24
500	.19	-145	4.11	79	.103	67	.49	-34
1000	.17	-179	2.25	57	.179	61	.47	-49
1500	.14	166	1.63	37	.246	52	.50	-68
2000	.08	-179	1.29	17	.287	39	.57	-87

VCE = -10 V, IC = -30 mA

100	.30	-80	13.70	119	.021	70	.68	-22
500	.22	-159	3.62	77	.099	69	.51	-31
1000	.21	168	1.99	54	.174	63	.51	-49
1500	.18	150	1.44	34	.238	54	.54	-68
2000	.10	140	1.15	14	.282	42	.59	-89

[查询"2SA1223"供应商](#)

TYPICAL COMMON EMITTER SCATTERING PARAMETERS

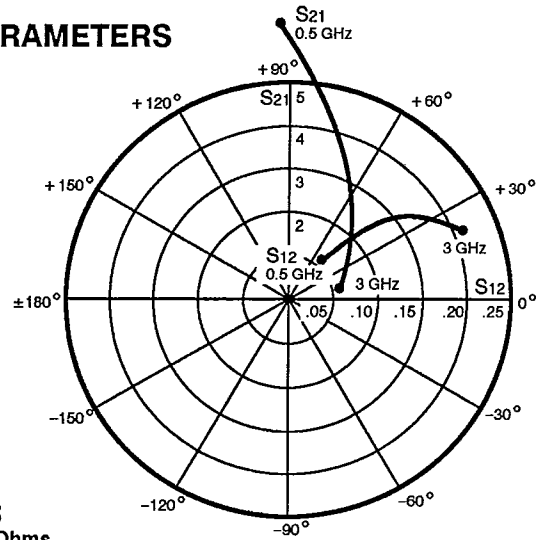
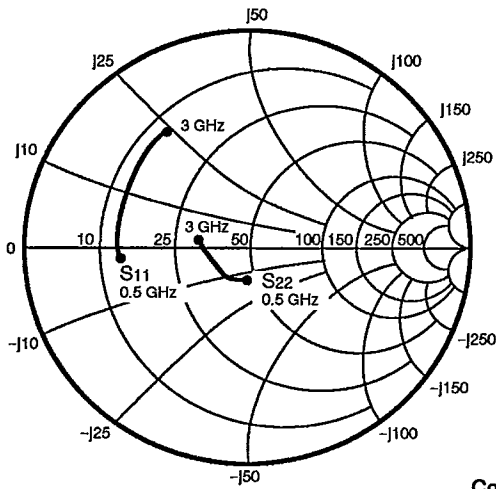

NE88935
Coordinates in Ohms
Frequency in GHz
(VCE = -10 V, IC = -20 mA, Zo = 50 Ω)

S-MAGN AND ANGLES:

VCE = -10 V, IC = -5 mA

FREQUENCY (MHz)

	S ₁₁		S ₂₁		S ₁₂		S ₂₂	
500	.46	-133	5.08	104	.11	40	.30	-56
1000	.54	-170	2.82	72	.14	29	.25	-96
2000	.56	153	1.51	38	.19	22	.19	-133
3000	.59	130	1.05	12	.24	10	.23	-168

VCE = -10 V, IC = -10 mA

500	.50	-160	6.11	97	.08	43	.18	-76
1000	.57	177	3.12	70	.11	38	.19	-117
2000	.59	147	1.63	38	.17	31	.16	-156
3000	.62	126	1.12	14	.22	18	.22	175

VCE = -10 V, IC = -20 mA

500	.56	-176	6.53	93	.06	50	.10	-95
1000	.59	170	3.19	68	.09	47	.15	-128
2000	.62	144	1.65	38	.16	38	.15	-163
3000	.65	125	1.12	13	.21	24	.21	172

VCE = -10 V, IC = -30 mA

500	.59	178	6.44	91	.06	54	.07	-94
1000	.60	168	3.10	67	.09	51	.14	-122
2000	.63	143	1.59	37	.16	40	.14	-157
3000	.66	124	1.07	12	.21	26	.21	178